

Expression of *hsp70*, *hsp90* and *hsf1* in the reef coral *Acropora digitifera* under prospective acidified conditions over the next several decades

Masako Nakamura^{1,*}, Masaya Morita^{2,#}, Haruko Kurihara³ and Satoshi Mitarai¹

¹Marine Biophysics Unit, Okinawa Institute of Science and Technology, Okinawa 904-0412, Japan

²Shimoda Marine Research Center, University of Tsukuba, Shizuoka 415-0025, Japan

³Trans-disciplinary Organization for Subtropical Island Studies, University of the Ryukyus, Okinawa 903-0213, Japan

*Corresponding author (masako.nakamura@oist.jp)

#Present address: Sesoko Station, Tropical Biosphere Research Center, University of the Ryukyus, Okinawa 903-0213, Japan

Biology Open 1, 75–81
doi: 10.1242/bio.2011036

Summary

Ocean acidification is an ongoing threat for marine organisms due to the increasing atmospheric CO₂ concentration. Seawater acidification has a serious impact on physiologic processes in marine organisms at all life stages. On the other hand, potential tolerance to external pH changes has been reported in coral larvae. Information about the possible mechanisms underlying such tolerance responses, however, is scarce. In the present study, we examined the effects of acidified seawater on the larvae of *Acropora digitifera* at the molecular level. We targeted two heat shock proteins, Hsp70 and Hsp90, and a heat shock transcription factor, Hsf1, because of their importance in stress responses and in early life developmental stages. Coral larvae were maintained under the ambient and elevated CO₂ conditions that are expected to occur within next 100 years, and then we evaluated the

expression of *hsps* and *hsf1* by quantitative real-time polymerase chain reaction (PCR). Expression levels of these molecules significantly differed among target genes, but they did not change significantly between CO₂ conditions. These findings indicate that the expression of *hsps* is not changed due to external pH changes, and suggest that tolerance to acidified seawater in coral larvae may not be related to *hsp* expression.

© 2011. Published by The Company of Biologists Ltd. This is an Open Access article distributed under the terms of the Creative Commons Attribution Non-Commercial Share Alike License (<http://creativecommons.org/licenses/by-nc-sa/3.0>).

Key words: larvae, scleractinian corals, heat shock proteins, ocean acidification

Introduction

Ocean acidification is a result of anthropogenic climate change and is challenging marine ecosystems (Hoegh-Guldberg and Bruno, 2010). The surface layers of the ocean are acidifying due to the absorption of anthropogenic CO₂ and have already absorbed approximately one-third of the human-produced CO₂, resulting in a decrease in the ocean pH by 0.1 pH unit from the pre-industrial era (Doney et al., 2009). Atmospheric CO₂ concentration, which is currently 380 ppm, is expected to rise to 1000 ppm by the end of the 21st century (Raven et al., 2005). Therefore, the ocean pH is expected to further decrease 0.3 to 0.5 pH units by 2100 (Caldeira and Wickett, 2005).

Seawater acidification has a serious impact on the physiologic processes in marine organisms throughout life, including fertility (e.g. Kurihara and Shirayama, 2004; Havenhand et al., 2008; Albright et al., 2010), calcification and/or growth rate (e.g. Fine and Tchernov, 2007; Kurihara et al., 2007; Dupont et al., 2008), metabolism (e.g. Reipschläger and Pörtner, 1996; Michaelidis et al., 2005), and metamorphosis/settlement (e.g. Albright et al., 2010; Nakamura et al., 2011). On the other hand, the survival of coral larvae are not obviously impacted by acidified seawater (Suwa et al., 2010; Nakamura et al., 2011), suggesting that coral larvae have some level of tolerance to external pH changes. The potential for metabolism suppression, a suggested survival

strategy under stressful conditions (Guppy and Withers, 1999), has been reported for coral larvae (Nakamura et al., 2011). Information on the mechanisms underlying a tolerance response to acidified seawater, however, is scarce. Only a few studies have focused on the responses to environmental pH changes at the molecular level in marine invertebrates (Hauton et al., 2009; O'Donnell et al., 2009; Todgham and Hofmann, 2009; O'Donnell et al., 2010) and none of these studies have focused on corals, although profiling and quantifying gene expression will strongly enhance our understanding of the physiologic response of marine organisms in an acidifying ocean.

Heat shock proteins (Hsps) are involved in cellular defense and morphologic changes of organisms at developmental stages (Feder and Hofmann, 1999; Gunter and Degnan, 2007). Although not all Hsps are stress-inducible, they respond to various environmental stressors such as extreme temperatures, pH extremes, anoxia, and various toxic substances (Feder and Hofmann, 1999; Dahlhoff, 2004). Such *hsps* expression is mainly regulated by heat shock factors (HSFs) (Sorger, 1991; Pirkkala et al., 2001).

Here, we observed the transcription levels of two Hsps (*hsp70* and *hsp90*) and an HSF (*hsf1*) when larvae of the scleractinian coral *Acropora digitifera* were exposed to acidified seawater for 1 to 7 days after fertilization. We also evaluated the expression

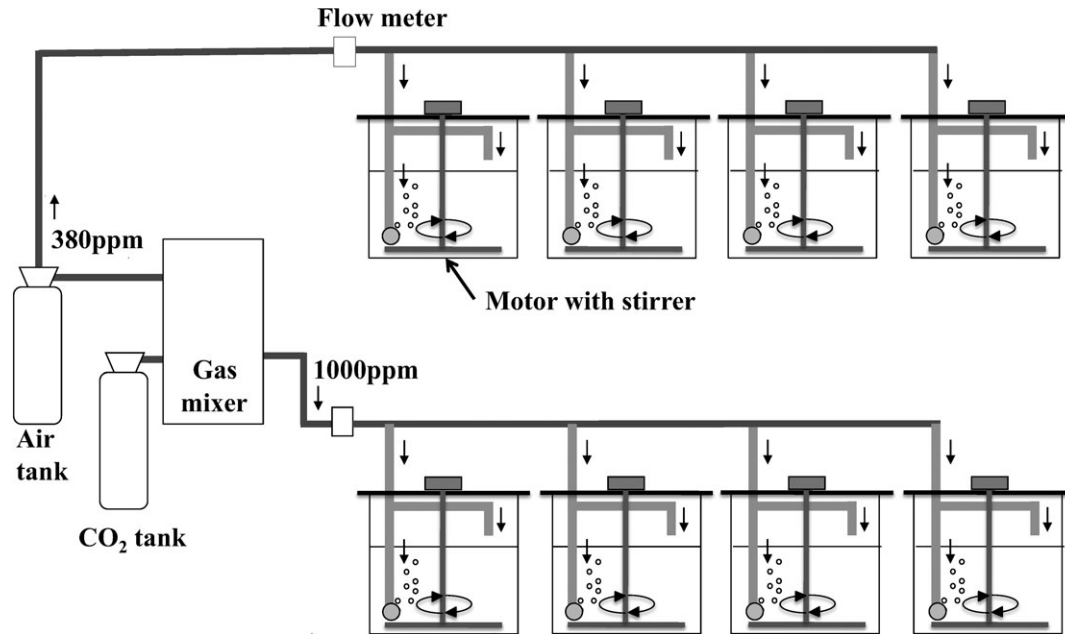

Fig. 1. Schematic of the aquarium settings for the pH treatment.

pattern of *hsps* during early developmental stages in the coral *A. digitifera* under normal conditions, the first study of its kind to be performed in corals.

Among the Hsp and HSF groups, we focused on the expression of *hsp70*, *hsp90*, and *hsf1* under acidified conditions to gain insight into the response to ocean acidification in coral larvae at the molecular level due to the importance of these genes in the stress response and in early life development. Hsp70 and Hsp90 are generally considered to contribute to stress responses (Freeman and Morimoto, 1996; Feder and Hofmann, 1999). In addition, their expression seems to be related to the activation of HSF1 (Morimoto, 1998; Zou et al., 1998). Hsp90s also have an important role in regulating metamorphosis and developmental plasticity in relation with environmental conditions (Bishop et al., 1998; Rutherford and Lindquist, 1998; Bishop et al., 2001; Queitsch et al., 2002; Baker, 2006). Therefore, evaluating the expression of *hsp70*, *hsp90*, and *hsf1* is a good starting point for investigating the relevancy of *hsps* expression in corals under acidified conditions with quantitative analyses.

Materials and Methods

Larval culture

A scleractinian coral species, *Acropora digitifera*, was used in the present study. This coral species distributes commonly around Okinawa coral reefs and is also the most commonly used species in studies of the effects of acidified seawater on several early life stages in coral (Morita et al., 2010; Suwa et al., 2010; Nakamura et al., 2011). This species is also an important model species because their genome has recently been sequenced (Shinzato et al., 2011).

Colonies of *A. digitifera*, identified as being sexually matured, were collected from fringing reefs around Sesoko Island, Okinawa, Japan (26°38'N, 127°53'E) one week before their predicted spawning date in June 2010. They were

maintained in a running seawater tank under natural light conditions at Sesoko Station, Tropical Biosphere Research Center, University of the Ryukyus.

Gametes were collected from five colonies on spawning nights according to Morita et al. (Morita et al., 2006), mixed, and fertilized. The fertilized gametes were kept in a container filled with filtered seawater (FSW, pore size 1 μ m). The FSW was exchanged at least twice per day before the experiment started to keep the gametes and/or larvae healthy.

Four aquariums (5L) with a cover were prepared for control and high pCO₂ (1000 ppm) conditions (Fig. 1). The CO₂ concentration of the seawater in the aquariums was controlled by aerating the FSW with air (control) or high CO₂ concentration gas (1000 ppm). The high CO₂ gas was produced by controlling the flow rate of air and pure CO₂ using mass flow controllers (Horiba STEC, Air: SEC-E50, CO₂: SEC-E40). The seawater and air layer of the aquariums were continuously aerated by the air or high CO₂ gas to maintain the partial pressure of CO₂ concentrations (P_{CO₂}) in the seawater at equilibrium. A flow meter (Kofloc RK-1250, Kyoto, Japan) was used to adjust the flow rate of air and high CO₂ gas for each aquarium. Temperature of the seawater in each aquarium was maintained at 27°C with water-coolers (REI-SEA LX-120EXA, IWAKI CO., Tokyo, Japan) and electric water-heaters.

Approximately 1500 larvae at 1 day post-fertilization (1 dpf) were placed in each aquarium with 3.2 L control or high CO₂ FSW. The seawater of each aquarium was exchanged once per day with pre-treated seawater aerated with air (control) or high CO₂ concentration gas (1000 ppm). At 1, 3, 5, and 7 days after culture, approximately 200 larvae were sampled from each aquarium for the experiments. Larvae of *A. digitifera* are lecithotrophic and they do not contain algal symbionts (zooxanthellae).

The pH (NBS scale) and temperature of the seawater were measured every day using a pH meter (Mettler Toledo, Seven Go). The salinity and total alkalinity were measured every 2 days using a salinometer (AS ONE, IS/Mill-E) and a total alkalinity titration analyzer (Kimoto ATT-05, Japan), and seawater carbonate chemistry was calculated using the program CO₂SYStools (Pierrot et al., 2006) (Table 1).

RNA extraction

Total RNA was extracted from a sample of approximately 200 larvae per tube. There were four replicates for each pH treatment for each observational day. Larvae were first fixed with RNA stabilization solution, RNAlater (Ambion), and

Table 1. Summary of physical conditions in the experimental aquaria at different CO₂ conditions.

CO ₂ condition	pH	Temperature (°C)	Salinity (‰)	TA (μ mol/kg)	pCO ₂ ^a (μ atm)	HCO ₃ ⁻ (μ mol/kg)	CO ₃ ²⁻ (μ mol/kg)	Ω_{Arag}
Control (380 ppm)	8.13 \pm 0.01	27.0 \pm 0.0	35.0 \pm 0.0	2255.1 \pm 3.9	492.3 \pm 24.0	1776.9 \pm 16.6	194.1 \pm 6.2	3.0 \pm 0.1
1000 ppm	7.89 \pm 0.00	27.0 \pm 0.0	35.0 \pm 0.0	2255.9 \pm 4.2	925.6 \pm 10.8	1954.9 \pm 3.9	122.1 \pm 0.9	1.9 \pm 0.0

stored at -80°C . Total RNA was then isolated using TRIzol Reagent (Invitrogen), following treatment with chloroform and 2-propanol. Total RNA pellets were then washed with 75% ethanol and dried. Dried total RNA pellets were resuspended in 25 μL nuclease-free water. RNA was quantified spectrophotometrically using an ND-1000 UV/visible spectrophotometer (NanoDrop technologies). TURBO DNA-free™ Kit (Applied Biosystems) was then used to remove contaminating DNA from the RNA preparations. cDNA was synthesized with AMV reverse transcriptase from total RNA prepared as described above, using a TaKaRa RNA PCR kit (AMV) Ver.3.0.

Quantitative real-time PCR analysis

Real-time PCR reactions were conducted in a total volume of 20 μL comprising 10 μL of Mastermix with SYBR green (Bio-Rad), 0.6 μL of each primer (1.2 μM), 0.3 μL of sample cDNA, and 8.5 μL ultrapure water. Real-time PCR reactions were run on a Thermal Cycler Dice Real time system TP800 (TAKARA BIO INC., Shiga, Japan) under the following reaction conditions: 1 cycle of [95°C for 3 min], 45 cycles of [94°C for 30 s \rightarrow 55°C for 30 s \rightarrow 72°C 30 s], and 1 cycle of [95°C for 15 s \rightarrow 60°C for 30 s \rightarrow 95°C for 15 s]. Data were normalized against the expression of actin, which was confirmed not to vary in response to CO₂ over the observational days by two-way factorial analysis of variance (ANOVA).

Primers were designed with Primer 3 (v. 0.4.0) software based on the partial sequence of each target gene of *A. digitifera* (Table 2).

Relative concentrations of mRNA for each pH treatment per observation day (x) were calculated using the following equation:

$$x = \left[\sum_i^m 1/2^{(\text{exCt}-\text{refCt})_i} \right] / 4$$

where i =aquarium number (1 to 4), $m=4$ (there are four aquariums for each pH treatment), exCt =experimental Ct, and refCt =Ct of reference gene (actin).

Rapid amplification of 5' and 3' cDNA ends (RACE) and phylogenetic-tree construction

The SMARTer™ RACE cDNA Amplification Kit (Clontech) was used for generating 5' and 3' cDNA sequences of *hsp70*, *hsp90*, and *hsf1*. Gene-specific 5' and 3' RACE and nested RACE primers for each gene were designed based on the nucleotide sequences of each gene fragment. The generated RACE-ready 5' and 3' cDNA, the kit reagents, and total RNA were used. First, PCR reactions were performed for each cDNA end for each gene using the universal primer (UPM) and the gene-specific RACE primers. Then, nested RACE reactions were conducted for each end of each gene by diluting the 1st PCR products as a template with the nested universal primer (NUP) and nested gene-specific primers. Conditions for both the 1st RACE and nested RACE PCR reactions were as follows; 5 cycles of [94°C for 30 s \rightarrow 72°C for 3 min], 5 cycles of [94°C for 30 s \rightarrow 74°C for 30 s \rightarrow 72°C for 3 min], and 35 cycles of [94°C for 30 s \rightarrow 68°C for 30 s \rightarrow 72°C for 3 min] with a final extension of 72°C for 3 min. The products of the 5' and 3' nested RACE PCR were gel-purified with Wizard SV Gel and PCR Clean-Up System (Promega), cloned into pGEM-T easy (Promega), and sequenced. The resulting sequences were compared to GenBank using a BLAST program: the nucleotide blast. The same processes were performed until the full sequence of each gene was obtained. Maximum-likelihood phylogenetic analyses were performed with PAUP*4.0b10 (Swofford, 2003). The appropriate model parameters for the maximum-likelihood analysis were determined using a likelihood-ratio test with Modeltest version 3.7 (Posada and Crandall, 1998; Posada and Buckley, 2004). The tree was searched using neighbor-joining methods based on maximum-likelihood distances from a best-fit model of nucleotide substitutions as determined by Modeltest.

Statistical analysis

Expression levels of the genes were compared among *hsp70*, *hsp90*, and *hsf1* over observation days under the control CO₂ condition using a two-way factorial ANOVA. To examine the effects of elevated CO₂ on the expression of *hsp70*,

hsp90, and *hsf1*, we performed a two-way factorial ANOVA with CO₂ treatment and observation day as factors. Tukey's HSD multiple comparison tests were conducted as a *post-hoc* test when the ANOVA detected significant differences. Data were log-transformed to meet normality and homoscedacity of variance criteria where necessary. All statistical analyses were performed by software JMP version 8.0.2.

Results

The genes coding for a 70-kDa heat shock protein (*hsp70*), a 90-kDa heat shock protein (*hsp90*), and a heat shock transcription factor1 (*hsf1*) were identified in the scleractinian coral, *Acropora digitifera*. The *hsp70* was 1633 nucleotides long, encoding a 219-amino acid protein in the open reading frame (ORF). A phylogenetic analysis demonstrated that the *hsp70* of a target species, *A. digitifera*, was structurally similar to other scleractinian corals (Fig. 2a). The *hsp90* was 2554 nucleotides long, encoding a 733-amino acid protein in the ORF. According to a phylogenetic analysis, the structure of *hsp90* was similar to that in other cnidarians (Fig. 2b). The *hsf1* was 2507 nucleotides long with an encoded 504-amino acid protein in the ORF. The structure of *hsf1* was also structurally similar to that of other cnidarians (Fig. 2c).

Comparison of the expression of three target genes under the control CO₂ condition

Transcripts of the three target genes were detected from Day 1 (2 dpf). The expression of these three target genes under the control condition differed significantly among the three genes through the experiment (Table 3) (Fig. 3). Expression of *hsp90* was significantly higher than that of the two other genes throughout the experiment. Expression of *hsp90* on Day 1 was more than 50-fold higher than that of the other genes and nearly 5-fold more than that of the other observation days for *hsp90* (Tukey HSD test, $P<0.05$). Expression of *hsp70* was relatively low throughout the experiment. The expression of *hsf1* was bit higher on Day 5 (6 dpf) than on the other days.

Expression of *hsp70* under elevated CO₂

Expression of *hsp70* was not significantly different between CO₂ conditions throughout the period of observation (ANOVA, $F_{\text{CO}_2 \text{ conditions} \times \text{Day}} = 1.1438$, $p=0.351$, Fig. 4). Expression under the elevated CO₂ condition during the first 2 days of observation (Day1 [2 dpf] and Day3 [4 dpf]) was relatively higher than that under the control condition and the other days under the elevated CO₂ condition.

Expression of *hsp90* under elevated CO₂

Expression of *hsp90* did not differ considerably between CO₂ conditions throughout the experiment, whereas expression was somewhat higher in the control condition than in the elevated CO₂ condition (Table 4) (Fig. 5). Expression was significantly higher on Day 1 than on the other days (Tukey HSD test, $P<0.05$), and then decreased on Day 3, and maintained a low level over the following days.

Expression of *hsf1* under elevated CO₂

Expression of *hsf1* did not vary significantly between CO₂ conditions throughout the observation (ANOVA, $F_{\text{CO}_2 \text{ conditions} \times \text{Day}} = 0.8503$, $p=0.48$, Fig. 6). The expression patterns were not consistent between CO₂ conditions. In the elevated CO₂ condition, expression showed a downward trend over time, whereas expression under the control condition was erratic,

Table 2. Primers for quantitative real-time PCR.

Gene	Sense	Antisense
<i>hsp70</i>	ATCAATTCCTC- AGCCAGTG	AGCGGATCTAAAG- GGAAACC
<i>hsp90</i>	CTTTTCGGTTGAA- GGTCAGC	GGAATGATGTCC- TCGCAGTT
<i>hsf1</i>	CCAGTTCACAG- TTTCA	TTCTACAACAC- ACGCGAAC
<i>Actin1</i>	GCAAAAAGGAAATT- GCTGCTC	CACATCTGTTGGAA- GGTGGA

a) Hsp70

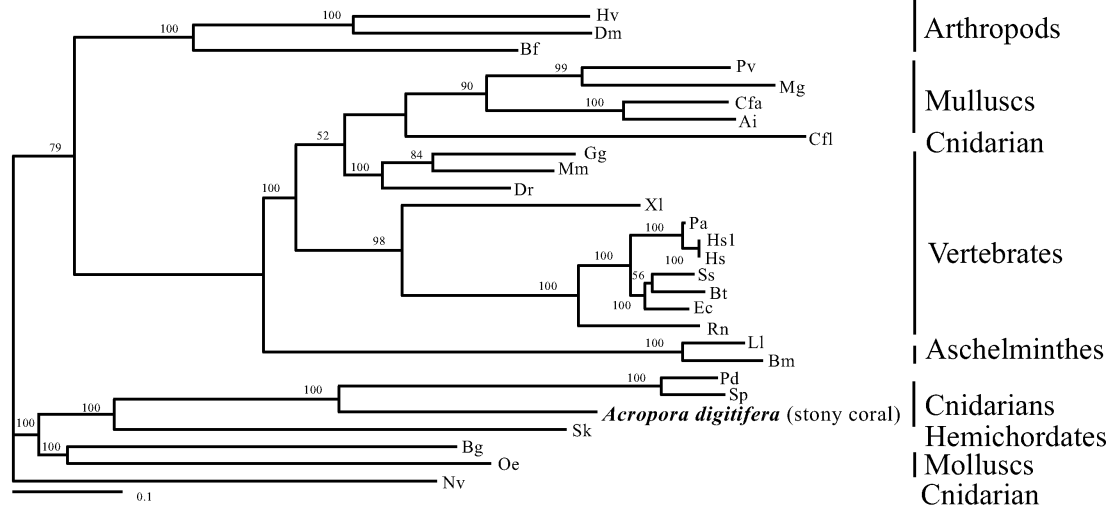

b) hsp90

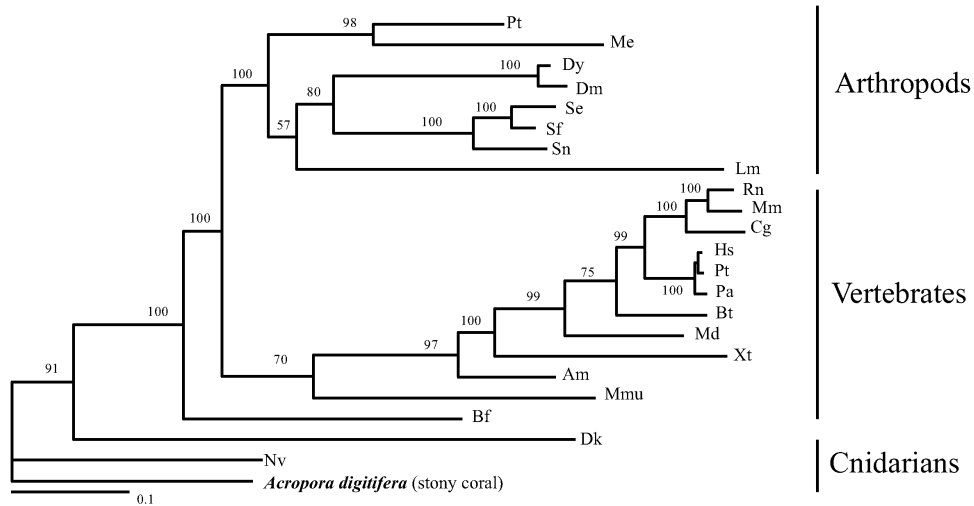

c) hsf1

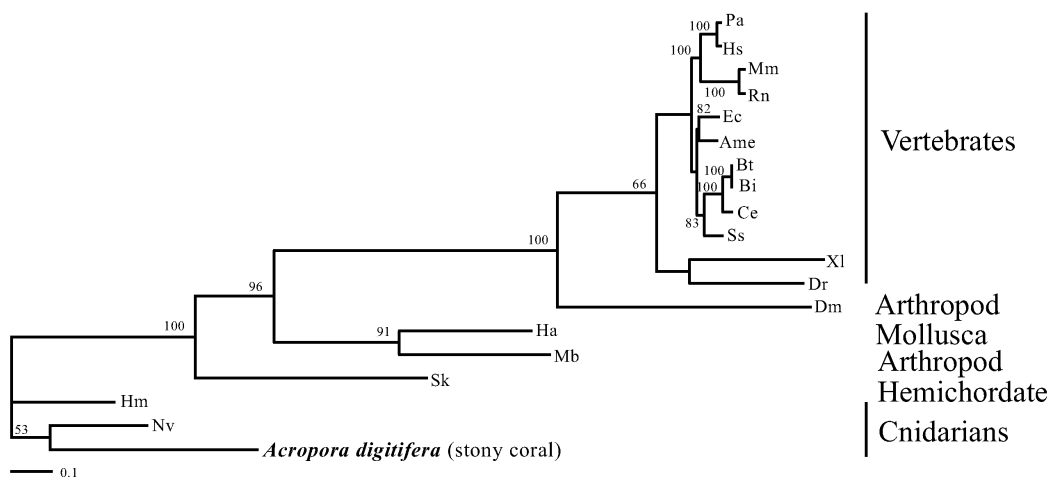

Fig. 2. See next page for legend.

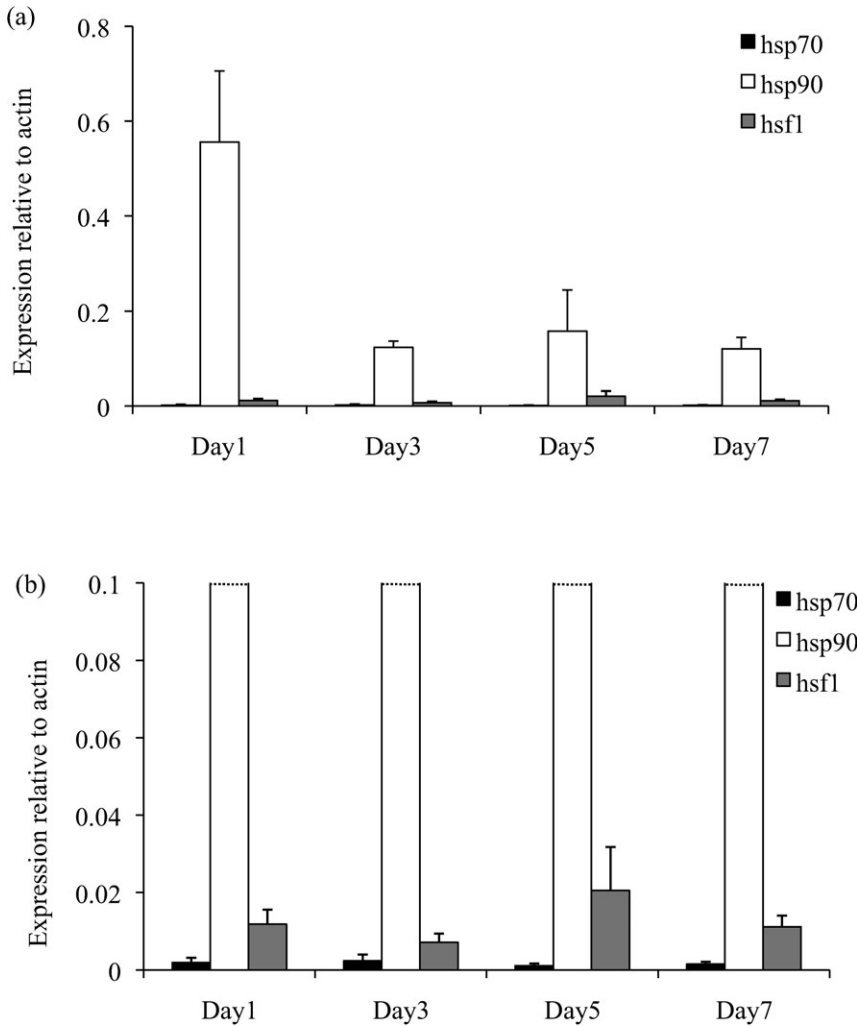

Fig. 3. Expression of *hsp70*, *hsp90*, and *hsf1* in the larvae of cultured *Acropora digitifera* in the control CO₂ condition (380 ppm) at 27°C over 7 days. (A) Overall view of the expression, (B) Enlarged view of y-axis from 0 to 0.1 of Fig. 3A. Error bars indicate mean and standard error (N=4).

Table 3. Two-way factorial ANOVA on the gene expression of larvae of *Acropora digitifera* in the control CO₂ condition (380 ppm).

Source	Df	Sum of squares	F	p
Gene	2	0.57723	28.1457	< 0.0001
Day	3	0.17905	5.8206	0.0024
Gene × Day	6	0.35831	5.8239	0.0003

showing a tendency to decrease during the first two days, then an increase at Day 5, and a decrease at Day 7.

Discussion

In the present study, we evaluated the expression of *hsp70*, *hsp90*, and *hsf1* to determine whether these genes are involved in the tolerance response against acidified conditions during the

Fig. 2. Phylogenetic trees of *hsp70*, *hsp90*, and *hsf1* amino acid sequences. (A) *hsp70*, (B) *hsp90*, and (C) *hsf1*. [Hv] *Heliothis virescens*, [Dm] *Drosophila melanogaster*, [Bf] *Branchiostoma floridae*, [Pv] *Perna viridis*, [Mg] *Mytilus galloprovincialis*, [Cfa] *Chlamys farreri*, [Ai] *Argopecten irradians*, [Cfl] *Chironex fleckeri*, [Gg] *Gallus gallus*, [Mm] *Mus musculus*, [Dr] *Danio rerio*, [Xl] *Xenopus laevis*, [Pa] *Pongo abelii*, [Hs1] *Homo sapiens* heat shock 70 kDa protein 1-like, [Hs] *Homo sapiens*, [Ss] *Sus scrofa*, [Bt] *Bos taurus*, [Ec] *Equus caballus*, [Rn] *Rattus norvegicus*, [Ll] *Loa loa*, [Bm] *Brugia malayi*, [Pd] *Pocillopora damicornis*, [Sp] *Stylophora pistillata*, [Sk] *Saccoglossus kowalevskii*, [Bg] *Biomphalaria glabrata*, [Oe] *Ostrea edulis*, [Nv] *Nematostella vectensis*, [Pt] *Portunus trituberculatus*, [Me] *Metapenaeus ensis*, [Dy] *Drosophila yakuba*, [Se] *Spodoptera exigua*, [Sf] *Spodoptera frugiperda*, [Sn] *Sesamia nonagrioides*, [Lm] *Locusta migratoria*, [Cg] *Cricetulus griseus*, [Pt] *Pan troglodytes*, [Md] *Monodelphis domestica*, [Xt] *Xenopus tropicalis*, [Am] *Alligator mississippiensis*, [Mmu] *Mus musculus*, [Dk] *Dendronephthya klunzingeri*, [Ame] *Ailuropoda melanoleuca*, [Bi] *Boa indicus*, [Ce] *Cervus eldi*, [Ss] *Sus scrofa*, [Dr] *Danio rerio*, [Ha] *Haliotis asinina*, [Mb] *Mamestra brassicae*, [Hm] *Hydra magnipapillata*.

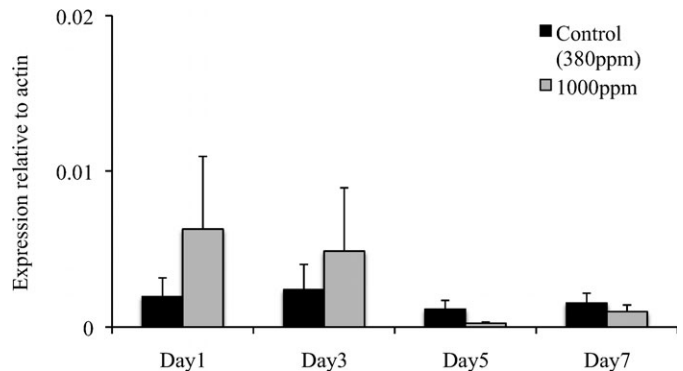

Fig. 4. Expression of *hsp70* in the larvae of cultured *Acropora digitifera* in the control and elevated CO₂ conditions at 27°C over 7 days. Error bars indicate mean and standard error (N=4).

Table 4. Two-way factorial ANOVA on the *hsp90* expression of larvae of *Acropora digitifera* in the different CO₂ conditions.

Source	Df	Sum of squares	F	p
CO ₂ condition	1	0.05319	0.5169	0.479
Day	3	3.26178	10.5663	< 0.001
CO ₂ condition × Day	3	0.07171	0.2323	0.872

larval stage in corals. Larvae are considered to have a number of cellular defense mechanisms to buffer the effects of environmental stressors (Goldstone et al., 2006; Hamdoun and Epel, 2007). If the expression of *hsps* and *hsf* change in acidified conditions, these stress proteins are likely to be involved in the stress response to acidified conditions (Feder and Hofmann, 1999; Dahlhoff, 2004).

In contrast to our hypothesis, the expression of *hsps* in coral larvae may not be affected by an external pH change. Our findings demonstrated that the expression levels of *hsp70*, *hsp90*, and *hsf1* in larvae of *Acropora digitifera* were poorly differentiated between the control and acidified conditions (Figs 4, 5, and 6). These findings indicate that the pH treatments do not induce heat shock proteins to refold some denatured cytoplasmic proteins by an acid/base imbalance due to external pH changes. Similar to our results, Hauton et al. (Hauton et al., 2009) reported no significant effect of acidified seawater on the expression of *hsp70* in the neritic amphipod *Gammarus locusta*, suggesting that physiologic buffering mechanisms are present in the tissues of *G. locusta* to cope with a decrease in external pH. Larvae of *A. digitifera* should be able to cope with the pH decrease that is expected to occur in this century at the cellular level.

Our next step will be to investigate effects of multiple environmental factors simultaneously to clarify the effects of acidified seawater on *hsp* expression in coral larvae, which was beyond the scope of the present study. For example, expression of *hsp70* in sea urchin larvae with a simultaneous temperature increase differs among pCO₂ conditions (380 ppm–970 ppm) (O'Donnell et al., 2009). Therefore, in sea urchin larvae, the stress response to thermal stressors is altered according to the acidified conditions.

Although the expression of *hsps* and *hsf1* did not change significantly under the acidified conditions, their expression was significantly different among genes under control conditions.

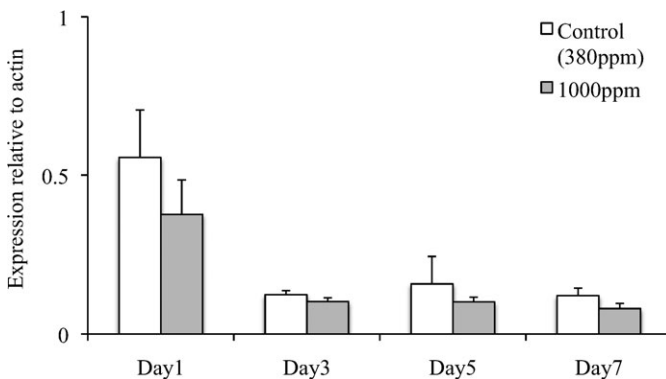
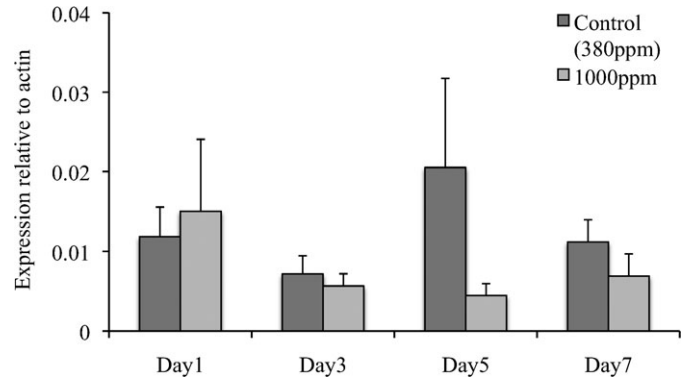
**Fig. 5. Expression of *hsp90* in the larvae of cultured *Acropora digitifera* in the control and elevated CO₂ conditions at 27°C over 7 days. Error bars indicate mean and standard error (N=4).****Fig. 6. Expression of *hsf1* in the larvae of cultured *Acropora digitifera* in the control and elevated CO₂ conditions at 27°C over 7 days. Error bars indicate mean and standard error (N=4).**

Hsp70, Hsp90, and HSF1 function differently at early life stages, including the larval stage. For example, Hsp70 is toxic in early development under ambient or non-stressful conditions (Krebs and Feder, 1997), as opposed to its beneficial effects on survival under stressful conditions (Feder et al., 1992). A low abundance of *hsp70* at larval stages was previously reported for the fruit fly and the silver sea bream (Velazquez et al., 1983; Deane and Woo, 2003), such as the coral *A. digitifera* (Fig. 3). This may explain the comparatively low expression of *hsp70* in the present study.

Contrary to the toxic characteristics of Hsp70 in early life stages, Hsp90 is among the most abundant proteins in the cytosol of eukaryotic cells (Mayer and Bukau, 1999), and the expression of *hsp90* is observed from very early developmental stages under normal unstressed conditions (e.g. Ali et al., 1998; Deane and Woo, 2003; Manchado et al., 2008). Hsp90 is also considered to control cell growth and differentiation (e.g. Krone et al., 1997; Mayer and Bukau, 1999; Deane and Woo, 2003; Krone et al., 2003) and to be involved in hormonal control, which regulates developmental changes in early development of larvae (e.g. Deane and Woo, 2003). Correspondingly, relatively higher expression levels of *hsp90* were detected in the present study, suggesting the importance of Hsp90 during early developmental stages.

In response to a multitude of stress conditions, HSF1 acquires DNA binding activity to the heat shock element, leading to the accumulation of Hsps (Wu, 1995; Morimoto, 1998). For instance, the accumulation of Hsp70 leads directly to the binding of Hsp70 to the HSF1 activation domain, and results in the repression of heat shock-induced transcription. This reaction subsequently converts HSF1 trimers to monomers, losing HSF1 DNA binding and then reading, to attenuate the heat shock response (Shi et al., 1998). Thus, Hsp70 may have a role in regulating HSF1 deactivation (Abravaya et al., 1992; Shi et al., 1998). As another example, Hsp90 has a role in maintaining HSF1 in an inert state (Ali et al., 1998; Zou et al., 1998; Bharadwaj et al., 1999). Therefore, these processes may account for the expression profiles of the three target genes in the present study; a relatively high expression of *hsp90* and substantially low expression of *hsp70* and *hsf1* throughout the experiment.

In conclusion, our findings are the first to demonstrate the expression patterns of *hsps* and *hsf1* during larval development in coral by observing the transcription levels of two Hsps and an HSF of coral larvae under acidified conditions. These findings

suggest that coral larvae are able to buffer the external pH changes that are expected to occur by the end of this century.

Acknowledgements

We would like to thank Profs. Takemura and Inaba for providing the laboratory space for the molecular experiments, Dr Yaguchi for advice regarding the quantitative PCR, and members of the Kurihara lab and the staff of Sesoko station at the University of the Ryukyus for supporting the aquarium setting and collecting the corals.

References

- Albright, R., Mason, B., Miller, M., and Landgon, C. (2010). Ocean acidification compromises recruitment success of the threatened Caribbean coral *Acropora palmata*. *Proc. Natl. Acad. Sci. USA* **107**, 20400-20404.
- Ali, A., Bharadwaj, S., O'Carroll, R., and Ovsenek, N. (1998). HSP90 interacts with and regulates the activity of heat shock factor 1 in *Xenopus* oocytes. *Mol. Cell Biol.* **18**, 4949-4960.
- Abrevaya, K., Myers, M. P., Murphy, S. P., and Morimoto, R. I. (1992). The human heat shock protein hsp70 interacts with HSF, the transcription factor that regulates heat shock gene expression. *Genes Dev.* **6**, 1153-1164.
- Baker, M. E. (2006). The genetic response to Snowball Earth: role of HSP90 in the Cambrian explosion. *Geobiology* **4**, 11-14.
- Bharadwaj, S., Ali, A., and Ovsenek, N. (1999). Multiple components of the HSP90 chaperone complex function in regulation of heat shock factor 1 in vivo. *Mol. Cell Biol.* **19**, 8033-8041.
- Bishop, C. D., Bates, W. R., and Brandhorst, B. P. (1998). Cell specific expression of HSP90 and induction of metamorphosis in ascidian larvae. *Dev. Biol.* **198**, 381.
- Bishop, C. D., Bates, W. R., and Brandhorst, B. P. (2001). Regulation of metamorphosis in ascidians involves NO/cGMP signaling and HSP90. *J. Exp. Zool.* **289**, 374-384.
- Caldeira, K., and Wickett, M. E. (2005). Ocean model prediction of chemistry changes from carbon dioxide emission to the atmosphere and ocean. *Geophys. Res. Lett.* **110**, C0904, doi: 10.1029/2004JC002671.
- Dahlhoff, E. P. (2004). Biochemical indicators of stress and metabolism: applications for marine ecological studies. *Annu. Rev. Physiol.* **66**, 183-207.
- Deane, E. E., and Woo, N. Y. S. (2003). Ontogeny of thyroid hormones, cortisol, hsp70 and hsp90 during silver sea bream larval development. *Life Science* **72**, 805-818.
- Doney, S. C., Fabry, V. J., Feely, R. A., and Kleypas, J. A. (2009). Ocean acidification: the other CO₂ problem. *Annu. Rev. Mar. Sci.* **1**, 169-192, doi: 10.1146/annurev.marine.010908.163834.
- Dupont, S., Harenhand, J., Thorndyke, W., Peck, L., and Thorndyke, M. (2008). Near-future level of CO₂-driven ocean acidification radically affects larval survival and development in the brittlestar *Ophiothrix fragilis*. *Mar. Ecol. Prog. Ser.* **373**, 285-294, doi: 10.3354/meps07800.
- Feder, J. H., Rossi, J. M., Solomon, J., Solomon, N., and Lindquist, S. (1992). The consequences of expressing hsp70 in *Drosophila* cells at normal temperatures. *Genes Dev.* **6**, 1402-1413.
- Feder, M. E., and Hofmann, G. E. (1999). Heat-shock proteins, molecular chaperones, and the stress response: evolutionary and ecological physiology. *Annu. Rev. Physiol.* **61**, 243-282.
- Fine, M., and Tchernov, D. (2007). Scleractinian coral species survive and recover from decalcification. *Science* **315**, 1811.
- Freeman, B. C., and Morimoto, R. I. (1996). The human cytosolic molecular chaperones hsp90, hsp70 (hsc70) and hsp71 have distinct roles in recognition of a non-native protein and protein refolding. *EMBO J.* **15**, 2969-2979.
- Goldstone, J. A., Hamdoun, A., Cole, B. J., Howard-Ashby, M., Nebert, D. W., Scally, M., Dean, M., Epel, D., Hahn, M. E., and Stegeman, J. J. (2006). The chemical defensome: environmental sensing and response genes in the *Strongylocentrotus purpuratus* genome. *Dev. Biol.* **300**, 366-384.
- Gunter, H. M., and Degnan, B. M. (2007). Developmental expression of Hsp90, Hsp70 and HSF during morphogenesis in the vetigastropod *Halotis asinine*. *Dev. Genes Evol.* **217**, 603-612.
- Guppy, M., and Withers, P. C. (1999). Metabolic depression in animals: physiological perspectives and biochemical generalizations. *Biol. Rev.* **74**, 1-40.
- Hamdoun, A., and Epel, D. (2007). Embryo stability and vulnerability in an always changing world. *Proc. Natl. Acad. Sci. USA* **104**, 1745-1750.
- Havenhand, J. N., Buttler, F. R., Thorndyke, M. C., and Williamson, J. E. (2008). Near-future levels of ocean acidification reduce fertilization success in a sea urchin. *Curr. Biol.* **18**, R651-R652.
- Hoegh-Guldberg, O., and Bruno, J. F. (2010). The impact of climate change on the world's marine ecosystems. *Science* **328**, 1523-1528, doi: 10.1126/science.1189930.
- Hauton, C., Tyrrell, T., and Williams, J. (2009). The subtle effects of sea water acidification on the amphipod *Gammarus locusta*. *Biogeosciences* **6**, 1479-1489.
- Krebs, R. A., and Feder, M. E. (1997). Deleterious consequences of Hsp70 overexpression in *Drosophila melanogaster* larvae. *Cell Stress Chaperones* **2**, 60-71.
- Krone, P. H., Sass, J. B., and Lele, Z. (1997). Heat shock protein gene expression during embryonic development of the zebrafish. *Cell. Mol. Life Sci.* **53**, 122-129.
- Krone, P. H., Evans, T. G., and Blechinger, S. R. (2003). Heat shock gene expression and function during zebrafish embryogenesis. *Semin. Cell Dev. Biol.* **14**, 267-274.
- Kurihara, H., and Shirayama, Y. (2004). Effects of increased atmospheric CO₂ on sea urchin early development. *Mar. Ecol. Prog. Ser.* **274**, 161-169.
- Kurihara, H., Kato, S., and Ishimatsu, A. (2007). Effects of increased seawater pCO₂ on early development of the oyster *Crassostrea gigas*. *Aquat. Biol.* **1**, 91-98.
- Manchado, M., Salas-Leiton, E., Infante, C., Ponce, M., Asensio, E., Crespo, A., Zuasti, E., and Cañavate, J. P. (2008). Molecular characterization, gene expression and transcriptional regulation of cytosolic HSP90 genes in the flatfish Senegalese sole (*Solea senegalensis* Kaup). *Gene* **416**, 77-84.
- Mayer, M. P., and Bukau, B. (1999). Molecular chaperones: The busy life of Hsp90. *Curr. Biol.* **9**, R322-R325.
- Morimoto, R. I. (1998). Regulation of the heat shock transcriptional response: cross talk between family of heat shock factors, molecular chaperones, and negative regulators. *Genes Dev.* **12**, 3788-3796.
- Michaelidis, B., Ouzounis, C., Paleras, A., and Pörtner, H. O. (2005). Effects of long-term moderate hypercapnia on acid-base balance and growth rate in marine mussels (*Mytilus galloprovincialis*). *Mar. Ecol. Prog. Ser.* **293**, 109-118.
- Morita, M., Nishikawa, A., Nakajima, A., Iguchi, A., Sakai, K., Takemura, A., and Okuno, M. (2006). Eggs regulate sperm flagellar motility initiation, chemotaxis, and inhibition in the coral, *Acropora digitifera*. *A. gemmifera*, and *A. tenuis*. *J. Exp. Biol.* **209**, 4574-4579.
- Morita, M., Suwa, R., Iguchi, A., Nakamura, M., Shimada, K., Sakai, K., and Suzuki, A. (2010). Ocean acidification reduces sperm flagellar motility in broadcast spawning reef invertebrates. *Zygote* **18**, 103-107, doi: 10.1017/S0967199409990177.
- Nakamura, M., Ohki, S., Suzuki, A., and Sakai, S. (2011). Coral larvae under ocean acidification: survival, metabolism, and metamorphosis. *PLoS ONE* **6**, e14521, doi: 10.1371/journal.pone.0014521.
- O'Donnell, M. J., Hammond, L. M., and Hofmann, G. E. (2009). Predicted impact of ocean acidification on a marine invertebrate: elevated CO₂ alters response to thermal stress in sea urchin larvae. *Mar. Biol.* **156**, 439-446.
- O'Donnell, M. J., Todgham, A. E., Sewell, M. A., Hammond, L. M., Ruggiero, K., Fanguy, N. A., Zippay, M. L., and Hofmann, G. E. (2010). Ocean acidification alters skeletogenesis and gene expression in larval sea urchins. *Mar. Ecol. Prog. Ser.* **398**, 157-171.
- Pierrot, D., Lewis, E., and Wallace, D. W. R. (2006). MS Excel Program Developed for CO₂ System Calculations. ORNL/CDIAC-105a. Carbon Dioxide Information Analysis Center, Oak Ridge National Laboratory, US Department of Energy, Oak Ridge, Tennessee.
- Pirkkala, L., Nykänen, P., and Sistonen, L. (2001). Roles of the heat shock transcription factors in regulation of the heat shock response and beyond. *FASEB J.* **15**, 1118-1131.
- Posada, D., and Buckley, T. R. (2004). Model selection and model averaging in phylogenetics: advantages of akaike information criterion and bayesian approaches over likelihood ratio tests. *Syst. Biol.* **53**, 793-808.
- Posada, D., and Crandall, K. A. (1998). MODELTEST: testing the model of DNA substitution. *Bioinformatics* **14**, 817-818.
- Queitsch, C., Sangster, T. A., and Lindquist, S. (2002). Hsp90 as a capacitor of phenotypic variation. *Nature* **417**, 618-624.
- Raven, J., Caldeira, K., Elderfield, H., Hoegh-Guldberg, O., Liss, P., Riebesell, U., Shepherd, J., Turley, C., and Watson, A. (2005). Ocean acidification due to increasing atmospheric carbon dioxide. Policy document 12/05, Royal Society.
- Reipschläger, A., and Pörtner, H. O. (1996). Metabolic depression during environmental stress: the role of extra- versus intracellular pH in *Sipunculus nudus*. *J. Exp. Biol.* **199**, 1801-1807.
- Rutherford, S. L., and Lindquist, S. (1998). HSP90 as a capacitor for morphological evolution. *Nature* **396**, 336-342.
- Shi, Y., Mosser, D. D., and Morimoto, R. I. (1998). Molecular chaperones as HSF1-specific transcriptional repressors. *Gene Dev.* **12**, 654-666.
- Shinzato, C., Shoguchi, E., Kawashima, T., Hamada, M., Hisata, K., Tanaka, M., Fujii, M., Fujiwara, M., Koyanagi, R., Ikuta, T., et al. (2011). Using the *Acropora digitifera* genome to understand coral responses to environmental change. *Nature* **476**, 320-323.
- Sorger, P. T. (1991). Heat shock factor and the heat shock response. *Cell* **65**, 363-366.
- Suwa, R., Nakamura, M., Morita, M., Shimada, K., Iguchi, A., Sakai, K., and Suzuki, A. (2010). Effects of acidified seawater on early life stages of scleractinian corals (Genus *Acropora*). *Fish. Sci.* **76**, 93-99.
- Swofford, D. L. (2003). PAUP*-Phlogenetic Analysis Using Parsimony And Other Methods Version 4. 0 Beta. Sunderland, USA: Sinauer Associates.
- Todgham, A. E., and Hofmann, G. E. (2009). Transcriptomic response of sea urchin larvae *Strongylocentrotus purpuratus* to CO₂-driven seawater acidification. *J. Exp. Biol.* **212**, 2579-2594.
- Velazquez, J. M., Sonoda, S., Bugaisky, G., and Lindquist, S. (1983). Is the major *Drosophila* heat shock protein present in cells that have not been heat shocked? *J. Cell Biol.* **96**, 286-290.
- Wu, C. (1995). Heat shock transcription factors: structure and regulation. *Annu. Rev. Cell Dev. Biol.* **11**, 441-469.
- Zou, J., Guo, Y., Guettouche, T., Smith, D. F., and Voellmy, R. (1998). Repression of heat shock transcription factor HSF1 activation by HSP90 (HSP90 complex) that forms a stress-sensitive complex with HSF1. *Cell* **94**, 471-480.