

## A novel regulatory mutation in the *C. elegans* sex determination gene *tra-2* defines a candidate ligand/receptor interaction site

Patricia E. Kuwabara

Medical Research Council, Laboratory of Molecular Biology, Hills Road, Cambridge CB2 2QH, UK

### SUMMARY

Sex determination in the nematode *C. elegans* is dependent on cell-to-cell communication, which appears to be mediated by the predicted membrane protein TRA-2A and the secreted protein HER-1. In XO males, HER-1 is hypothesised to function as a repressive ligand that inactivates the TRA-2A receptor. In XX animals, HER-1 is absent and TRA-2A promotes hermaphrodite development by negatively regulating the FEM proteins. This paper describes the molecular and genetic characterisation of a novel class of feminising mutations called *tra-2(eg)*, for enhanced gain-of-function. In XX animals, mutant *tra-2(eg)* activity promotes entirely normal hermaphrodite development. However, the *tra-2(eg)* mutations generate an XO-specific gain-of-function phenotype, because they transform XO mutants from male into hermaphrodite.

Therefore, the *tra-2(eg)* mutations identify a major regulatory site, which may be the TRA-2A/HER-1 interaction site. All ten *tra-2(eg)* mutations encode identical missense changes in a predicted extracellular domain of TRA-2A, named the EG site. It is proposed that the *tra-2(eg)* mutation encodes a TRA-2A protein that functions constitutively in XO animals, because it is defective in HER-1 binding. Phenotypic characterisation of sexually transformed XO *tra-2(eg)* hermaphrodites reveals that their fertility is strongly affected by dosage compensation mutations, suggesting that dosage compensation plays a role in normal gametogenesis.

Key words: sex determination, *Caenorhabditis elegans*, hermaphrodite, ligand, receptor

### INTRODUCTION

The nematode *C. elegans* naturally exists as either an XX hermaphrodite or an XO male. The *C. elegans* hermaphrodite is essentially a self-fertile female: her soma is indistinguishable from females of closely related, but exclusively male/female nematodes (Baird et al., 1994), and her germ line produces sperm first, then oocytes. The primary determinant of sex in *C. elegans* is the ratio of X chromosomes to sets of autosomes - the X:A ratio (Madl and Herman, 1979). In response to the X:A ratio, the *xol* and *sdv* genes control both dosage compensation and sex determination (Fig. 1A). Dosage compensation equalises X-linked transcription between XX and XO diploids (for review, see Hsu and Meyer, 1993). An additional set of seven genes, *her-1*, *tra-1*, *tra-2*, *tra-3*, *fem-1*, *fem-2* and *fem-3*, control sexual fate, but have no apparent role in dosage compensation (for details of the pathway, refer to legend for Fig. 1) (reviewed in Villeneuve and Meyer, 1990; Kuwabara and Kimble, 1992). The terminal regulator of somatic sexual cell fate is *tra-1*, which promotes XX hermaphrodite somatic development (Hodgkin and Brenner, 1977; Zarkower and Hodgkin, 1992).

The *tra-2* gene plays a central role in controlling somatic and germ-line sexual cell fate. XX mutants that lack wild-type *tra-2* have a male soma and a germ line that produces only sperm; XO *tra-2* mutants are normal males. This paper focuses on the regulation of TRA-2A (Kuwabara et al., 1992), the

predicted membrane protein encoded by the largest of three *tra-2* mRNAs (4.7 kb, 1.9 kb and 1.8 kb) (Okkema and Kimble, 1991). TRA-2A is the component of the *tra-2* locus that is both necessary and sufficient to promote female somatic development (Kuwabara and Kimble, 1995).

It has been proposed that the membrane protein TRA-2A functions as a receptor that controls sexual cell fate through its participation in various protein-protein interactions (Fig. 1A,B) (Kuwabara et al., 1992; Kuwabara and Kimble, 1995). In XX animals, TRA-2A is likely to function constitutively, because no positively acting ligand has been identified (Kuwabara et al., 1992). Recent evidence indicates that a carboxy terminal domain of TRA-2A inhibits the activity of one or more of the *fem* gene products, perhaps through sequestration (Fig. 1B) (Kuwabara and Kimble, 1995). As a result of low FEM activity, TRA-1, a zinc finger protein and putative transcriptional regulator, promotes hermaphrodite somatic development (Zarkower and Hodgkin, 1992).

In XO animals, it is postulated that TRA-2A is inactivated by a repressive ligand, named HER-1 (Fig. 1A,B), which is predicted to be secreted (Perry et al., 1993) and to function cell non-autonomously (Hunter and Wood, 1992). This repression is likely to be XO-specific, because *her-1* mRNAs are detected only in XO animals (Trent et al., 1991). Inactivation of TRA-2A, in turn, allows the FEM proteins to promote male development by inhibiting TRA-1 activity. Therefore, cell-to-cell signalling mediated by TRA-2A and HER-1 is a crucial step

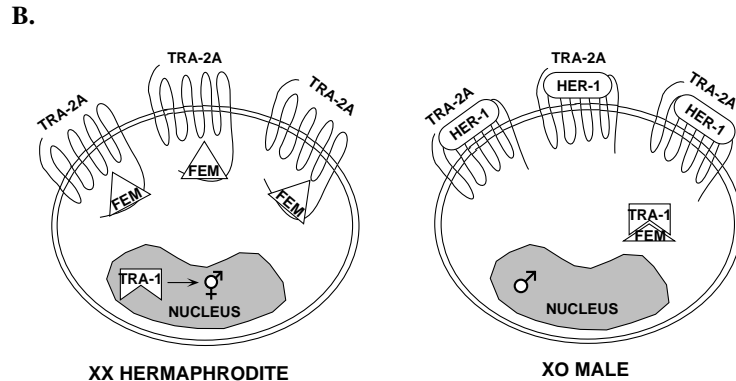
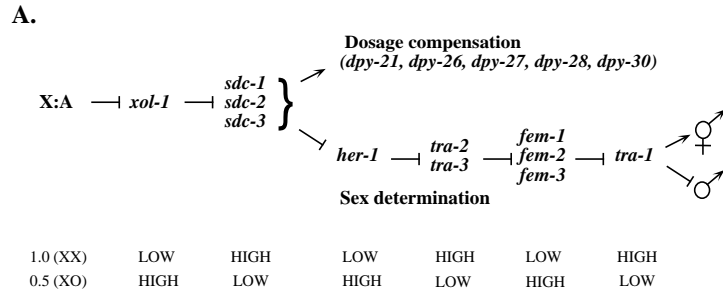

are detected in XO, but not XX animals (Trent et al., 1991). The HER-1 protein encodes a predicted secreted protein that functions cell non-autonomously to promote male development (Perry et al., 1993; Hunter and Wood, 1992). It is postulated that HER-1 is a repressive ligand that inactivates TRA-2A. In turn, the FEM proteins are released from inhibition and promote male development by negatively regulating TRA-1.

in controlling sexual cell fate decisions (Kuwabara et al., 1992; Hunter and Wood, 1992). The function of this cell-to-cell signalling event may be to ensure that all cells in the nematode adopt only one of two possible sexual fates (Kuwabara et al., 1992).

TRA-2A is an unusual cell surface receptor in that the HER-1 ligand is proposed to repress TRA-2A rather than to activate it (Kuwabara et al., 1992). In most other signal transduction processes, ligand binding leads to receptor activation (e.g. EGF action on EGF receptor, for review see Heldin, 1995). However, repressive ligand/receptor interactions may be more widespread than is presently apparent. A similar negative interaction has been proposed to occur between the *Drosophila hedgehog* and *patched* proteins during positional signalling (Ingham et al., 1991). The protein sequences of *patched* and *tra-2* share marginal similarity (Kuwabara et al., 1992). Clearly, a molecular understanding of the function and regulation of TRA-2A activity is essential to understand sex determination in *C. elegans* at the biochemical level and more generally to explore the mechanisms of repressive ligand/receptor interactions.

This paper investigates the regulation of TRA-2A by HER-1 by presenting the molecular and genetic characterisation of a novel class of dominant XO-feminising mutations. These mutations, named *tra-2(eg)* for enhanced gain-of-function, are shown to encode missense changes in a predicted extracellular domain of TRA-2A. The phenotypic properties of the *tra-2(eg)* mutation have also been analysed in detail by obtaining an intragenic recombinant that carries only the *tra-2(eg)* mutation, because all of the *tra-2(eg)* mutations were originally isolated as *tra-2(gf, eg)* double mutations (Hodgkin and Albertson,

**Fig. 1.** (A) Genetic pathway of sex determination and dosage compensation in *C. elegans* (modified from Hodgkin, 1990; Villeneuve and Meyer, 1990). The X:A ratio is the primary determinant of sex and sets the activity states (designated high or low) of the genes *xol-1*, *sdc-1*, -2 and -3, which regulate both sex determination and dosage compensation. In XX animals, the *sdc* genes are active and negatively regulate *her-1*, probably at the transcriptional level, because *her-1* mRNAs are detected in XX, but not XO animals (Trent et al., 1991). In turn, the *tra-2* and *tra-3* genes are active and negatively regulate the *fem* genes. Inhibition of *fem* gene activity allows *tra-1* to promote female somatic development. High *sdc* gene activity also activates the dosage compensation *dpy* genes, which function to lower X-linked transcription. In XO animals, high *xol-1* activity negatively regulates the *sdc* genes. In turn, *her-1* negatively regulates the activities of *tra-2* and *tra-3*. Inhibition of *tra-2* and *tra-3* activities allows the *fem* genes to promote male development by negatively regulating *tra-1*. Low *sdc* activity prevents the activation of dosage compensation XO males. (B) Molecular model of somatic sex determination in *C. elegans* (adapted from Kuwabara et al., 1992). Left, XX hermaphrodite development. TRA-2A is depicted as a membrane protein with an extracellular amino terminus and an intracellular carboxy terminal tail. A carboxy terminal region of TRA-2A is likely to inhibit the activity of the *fem* gene products, perhaps by sequestration (Kuwabara and Kimble, 1995). In turn, TRA-1 functions in the nucleus to promote hermaphrodite somatic development. Right, XO male development. *her-1* mRNAs

1995). The recombinant *tra-2(eg)* mutation results in a dominant transformation of XO animals from male into hermaphrodite, demonstrating the status of *tra-2* as a switch gene controlling all aspects of sexual phenotype. Taken together, the molecular and genetic properties of the *tra-2(eg)* mutations indicate that these mutations are likely to identify a region of direct interaction between TRA-2A and HER-1. The genetic analysis of the *tra-2(eg)* mutations has also led to the unexpected finding that the fertility of XO *tra-2(eg)* mutants is dramatically improved by mutations in genes involved in dosage compensation. This observation provokes the speculation that interactions may exist between the sex determination and dosage compensation pathways in the hermaphrodite germ line.

## MATERIALS AND METHODS

### Nematode culture, strains and general handling methods

General methods for genetic manipulation, culturing and synchronisation of nematodes have been described (Brenner, 1974; Sulston and Hodgkin, 1988). All genetic characterisations were at 20°C unless otherwise indicated, using worms that were not starved or recovering from the dauer state.

Standard nomenclature is used in this paper (Horvitz et al., 1979). The suffix *gf* designates gain-of-function and *eg* designates enhanced gain-of-function. Unless otherwise stated, it is implicit that all other alleles are loss-of-function (*lf*). When the maternal and zygotic genotypes are important the superscripts <sup>+</sup> or <sup>-</sup> refer to the presence or absence of gene activity. The following mutations and chromosomal rearrangements were used. Most mutations in this paper are described elsewhere (Hodgkin et al., 1988).

Linkage group (LG) II: *dpy-2(e8)*, *dpy-10(e128)*, *tra-2(e1095)*, *q276*, *e2046gf*, *unc-104(e1265)*, *unc-4(e120)*, *mnC1*.

LGIII: *dpy-28(y1)*

LGIV: *unc-24(e138)*, *fem-3(q20gf)*, *him-8(e1489)*, *dpy-20(e1282)*, *dpy-26(n199)*, *tra-3(e1767)*

LGV: *him-5(e1490)*, *her-1(n695gf)*

LGX: *unc-7(e5)*

### Molecular cloning methods

General methods for manipulating nucleic acids are described by Sambrook et al. (1989). Nematode DNA was prepared as described by Emmons and Yesner (1984). Nematode RNA was isolated by the guanidinium thiocyanate protocol of Chirgwin et al. (1979). Poly (A)<sup>+</sup> mRNA was selected on oligo(dT) cellulose (Pharmacia). Synchronised populations of nematodes were obtained by hypochlorite treatment of gravid adults to obtain eggs, followed by an arrest at the L1 stage by starvation in M9 buffer. Animals were subsequently fed and harvested as gravid adults.

Genomic DNA was amplified by the polymerase chain reaction (PCR), cloned and sequenced. Worm genomic DNA was subjected to 35 cycles of amplification using Taq polymerase (Promega) as directed by the manufacturer using the following parameters: 95°C for 50 seconds, 55°C for 50 seconds, 72°C for 1 minute per kb of final amplified product, followed by a final extension at 72°C for 10 minutes. PCR amplified fragments were made blunt with DNA polymerase I Klenow fragment (Cambios), phosphorylated with T4 kinase (New England Biolabs), gel purified using GeneClean (Bio 101) and ligated into the *EcoRV* site of pBSKSII(+) (Stratagene), which had been treated with calf intestine alkaline phosphatase (Boehringer Mannheim). Double-stranded templates were sequenced with Sequenase (United States Biochemical).

### Sequence and location of oligonucleotide primers

Oligonucleotides used to amplify *tra-2* gene regions are listed below. The positions of *tra-2* oligonucleotides are listed in brackets and are based on the numbering of the 4.7 kb *tra-2* cDNA sequence (Kuwabara et al., 1992).

PK21 GTTGAGGTCGAGTGGACGAT (*mx* and 3' UTR) (4613-4632)  
 PK27 ATTGGAATAAGAATACCGAC (*eg*) (527-546)  
 PK59 ATTTGGGAGCATGTCCTTCC (*mx* and 3' UTR) (4051-4070)  
 PK101 ATCGACATCTTCTAATTTGAACT (*eg*) (869-891)  
 PK36 TACCGCTGTCGGGTCT (Northern probe) (3354-3371)  
 PK81 TTCTGAAAAGGAAACAGACATT (Northern probe) (4465-4487)

### Molecular characterisation of *tra-2(eg)* mutations

To determine the molecular basis of the *tra-2(eg)* mutations, genomic DNA was isolated from ten homozygous strains of genotype *tra-2(gf, eg) unc-4; fem-3(gf) dpy-20*, carrying ten independent *eg* alleles (*e2531*, *e2534*, *e2536*, *e2538*, *e2540*, *e2552*, *e2555*, *e2571*, *e2581*, and *e2582eg*). Regions corresponding to the *tra-2* 3' UTR, *mx* (for mixed character) region and exons were PCR amplified, cloned and sequenced, as described above. To minimise the risk of PCR-induced artefacts, all sequence changes were verified by analysing an independently generated PCR fragment. To control for potential polymorphisms between strains, DNA was cloned and sequenced from the *tra-2(eg)* parental strain: CB4915 = *tra-2(e2046gf); dpy-28*. This strain was placed in cryostorage after the first two *tra-2(eg)* mutants were obtained and was subsequently thawed for DNA analysis (J. Hodgkin, personal communication). Therefore, any base change present in a *tra-2(eg)* mutant and absent from the CB4915 parent must have been independently introduced into each mutant as a result of mutagenesis.

### Intragenic recombination to separate *tra-2(e2531eg)* from *tra-2(e2046gf)*

The following strategy was used to identify an intragenic recombinant that carries the *tra-2(e2531eg)* mutation, but not the *tra-*

*2(e2046gf)* mutation. Heterozygous + *tra-2(e2046gf, e2531eg)* + *dpy-2* + *unc-104* non-Dpy non-Unc females were mated with *dpy-2* + *unc-104/mnC1* males and F<sub>1</sub> progeny were screened for Dpy non-Unc recombinants. Female recombinants were propagated by mating with XO *dpy-2 unc-104/mnC1* males and hermaphrodite recombinants were selfed. The genotype of each recombinant was determined by cloning and sequencing regions associated with the *tra-2(eg)* and *tra-2(e2046gf)* mutations.

To separate *tra-2(e2531eg)* from the closely linked marker, *dpy-2*, the following strategy was used. Homozygous *dpy-2 tra-2(e2531eg)* hermaphrodites were mated to XO *tra-2* males and *dpy-2 tra-2(e2531eg)/+ tra-2* non-Dpy progeny were individually plated to identify a recombinant that segregated only XX *tra-2* pseudomales and *tra-2(e2531eg)* non-Dpy progeny. 1/43 plates was found to have such a recombinant. Eight hermaphrodites from this plate were individually plated and 2/8 segregated non-pseudomale non-Dpy progeny and thus were likely to be XX *tra-2(e2531eg)* homozygotes.

### Phenotype of animals homozygous for *tra-2(eg)*

The sexual phenotype of the somatic gonad, hypodermis, tail and germ line of adult XX and XO animals carrying the *tra-2(e2531eg)* mutation was examined by dissecting microscope and Nomarski DIC optics. Brood sizes were counted by individually plating L4 hermaphrodites on plates and transferring them daily to fresh plates until they stopped producing eggs. Eggs were scored as dead if they failed to hatch within 24 hours. To eliminate potential deleterious XO maternal effects, siblings were chosen from an XX *tra-2(e2531eg); him-8* hermaphrodite that produced >200 self-progeny.

### Analysis of *tra-2(e2531eg)/+* animals

The phenotype of XX and XO animals carrying a single dose of *tra-2(e2531eg)* was examined by mating *tra-2(e2531eg)unc-4* hermaphrodites to wild-type males and scoring non-Unc cross-progeny. To determine whether masculinised animals were XX or XO, the strain *tra-2(e2531eg); unc-7*, which carries an X-linked marker, *unc-7*, was constructed. In constructing this strain, XX *tra-2(q276); unc-7/+* non-Unc males were used to introduce the *unc-7* marker into *tra-2(e2531eg)*. Subsequently, *tra-2(e2531eg); unc-7* hermaphrodites were mated with wild-type XO males and the sexual phenotype of Unc and non-Unc progeny scored.

### Northern blot analysis

RNA was extracted from synchronised adult XX populations of *tra-2(e2531eg)* and wild-type hermaphrodites, poly(A)<sup>+</sup> selected on sepharose oligo(dT) and electrophoresed on 1.5% formaldehyde-agarose gels for northern analysis. Northern blots were hybridised as described in Sambrook et al. (1989) using a random primed PCR fragment, amplified from lambda JK57 (Kuwabara et al., 1992) with oligonucleotides PK36 and PK81 (see above for sequence). This probe detects all *tra-2* mRNAs (Okkema and Kimble, 1991). As a loading control, the Northern blot was rehybridised with *myo-1* (Miller et al., 1986), a myosin specifically expressed in pharyngeal muscle. Densitometry of transcript bands was performed using a Molecular Dynamics Series 300 densitometer to calculate the mean peak area (expressed in arbitrary units).

## RESULTS

### Molecular localisation of the *tra-2(eg)* mutations

The *tra-2(gf, eg)* double mutations are the first *tra-2* mutations that completely feminise both the soma and germ line of XO males (Hodgkin and Albertson, 1995). Previously characterised *tra-2(gf)* and *tra-2(mx)* mutations feminise primarily the XX germ line and have little or no effect on XO animals; hermaphrodites produce oocytes, but not sperm (Doniach,

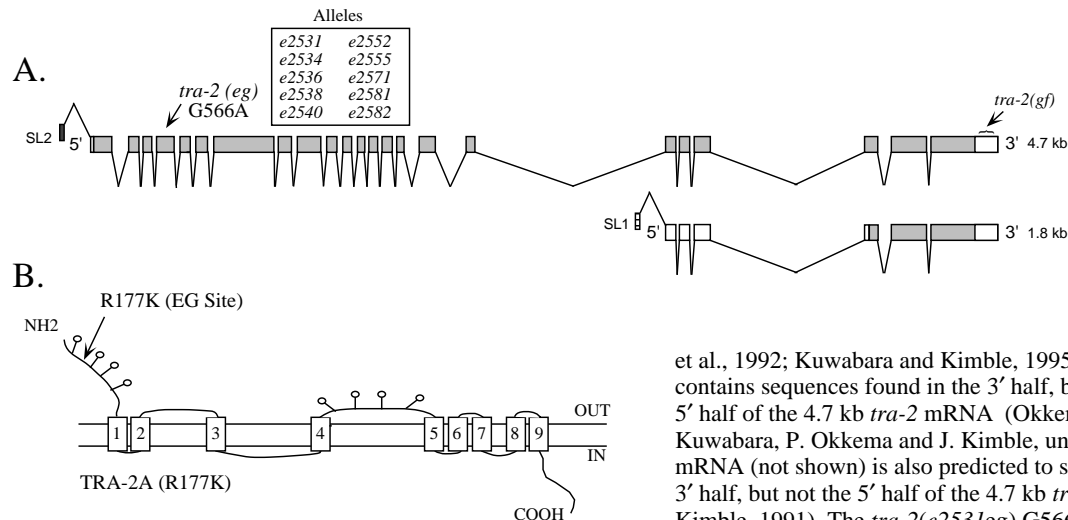

the 3' end of the *tra-2* coding region (not shown). (B) Schematic representation of TRA-2A, the predicted product of the 4.7 kb *tra-2* mRNA. Hydropathy analysis predicts that TRA-2A is a membrane protein with nine potential membrane spanning domains (Kuwabara et al., 1992, Kyte and Doolittle, 1982). The *tra-2(e2531eg)* mutation encodes an R177K amino acid change in a putative extracellular domain of TRA-2A, named the EG site. Ball and stick symbols refer to potential sites of glycosylation (Kuwabara et al., 1992).

1986; Schedl and Kimble, 1988). To establish that the *tra-2(eg)* mutations are not simply stronger *tra-2(gf)* or *tra-2(mx)* alleles, DNA was cloned from *tra-2(e2046gf, e2531eg)* animals and the *tra-2(gf)* (Goodwin et al., 1993) and *tra-2(mx)* (P. Kuwabara, P. Okkema and J. Kimble, unpublished data) regions analysed. As anticipated, homozygous *tra-2(e2046gf, e2531eg)* animals still carry the original *tra-2(e2046gf)* mutation, which is a deletion of a 28 nt direct repeat element in the 3' UTR (Fig. 2A) (Kuwabara et al., 1992; Goodwin et al., 1993), and no other alterations to the 3' UTR. In addition, the sequence of the *tra-2(mx)* region is wild-type. Therefore, the *tra-2(eg)* mutations define a new class of *tra-2* feminising mutations at the molecular level.

The molecular basis of the *tra-2(eg)* mutations was determined by sequencing *tra-2(e2046gf, e2531eg)* exons (see Materials and Methods for details). A single G566A base change was found in two independent clones (Fig. 2A,B) (numbering is based on the sequence of the 4.7 kb *tra-2* cDNA and its predicted protein product TRA-2A; Kuwabara et al., 1992). It became a concern that the G566A base change might be unrelated to the *tra-2(eg)* mutation when the remaining nine *tra-2(eg)* mutants were also found to carry the identical base change (Fig. 2A). However, DNA in this region from the parental strain of the *tra-2(eg)* mutants was found to be wild-type (refer to Materials and Methods). Therefore, the G566A base change is responsible for the *tra-2(eg)* mutant phenotype. Subsequent characterisations of the *tra-2(eg)* mutation have been performed using the *tra-2(e2531eg)* allele.

The *tra-2(eg)* G566A base change encodes an R177K missense mutation, which is located in the first putative extracellular domain of TRA-2A (Fig. 2B). The site of the R177K missense mutation has been named the EG site. It is not present in proteins encoded by other *tra-2* mRNAs (Fig. 2A) (Okkema and Kimble, 1991; P. Kuwabara, P. Okkema and J. Kimble, unpublished data).

**Fig. 2.** Site of *tra-2(eg)* mutations. (A) Intron/Exon map of *tra-2* locus (Adapted from Kuwabara et al., 1992; P. Kuwabara, P. Okkema and J. Kimble, unpublished data). Three *tra-2* mRNAs of 4.7, 1.8 and 1.9 kb have been identified (Okkema and Kimble, 1991). The 4.7 kb *tra-2* mRNA provides the major feminising component of the *tra-2* locus (Kuwabara

et al., 1992; Kuwabara and Kimble, 1995). The 1.8 kb *tra-2* mRNA contains sequences found in the 3' half, but lacks sequences found in the 5' half of the 4.7 kb *tra-2* mRNA (Okkema and Kimble, 1991; P. Kuwabara, P. Okkema and J. Kimble, unpublished data). The 1.9 kb *tra-2* mRNA (not shown) is also predicted to share sequence similarity with the 3' half, but not the 5' half of the 4.7 kb *tra-2* mRNA (Okkema and Kimble, 1991). The *tra-2(e2531eg)* G566A mutation disrupts only the 4.7 kb *tra-2* mRNA and not the smaller *tra-2* transcripts. The site of the *tra-2(gf)* feminising mutations is indicated. *tra-2(mx)* mutations map toward

### Separation of the *tra-2(e2531eg)* mutation from the *tra-2(e2046gf)* mutation by intragenic recombination

XX *tra-2(gf, eg)* double mutants are females (spermless hermaphrodites), probably because they carry the germ-line feminising *tra-2(e2046gf)* mutation. To analyse properly the effect of the *tra-2(e2531eg)* mutation, it was essential to separate it from the *tra-2(e2046gf)* mutation. Although the distance separating these two mutations is less than 10 kb, it proved possible to isolate the *tra-2(eg)* mutation by intragenic recombination (see Material and Methods for details). Four female and one hermaphrodite recombinant were obtained in a narrow region flanking *tra-2*. DNA sequencing revealed that the four female recombinants still carried the germ-line feminising *tra-2(e2046gf)* mutation, whereas the hermaphrodite recombinant did not. The hermaphrodite recombinant, however, did carry the *tra-2(e2531eg)* mutation as shown by sequencing. It follows that XX *tra-2(e2531eg)* animals are self-fertile hermaphrodites, not females.

### XX *tra-2(e2531eg)* hermaphrodites are phenotypically wild type

No phenotypic differences were detected between XX *tra-2(e2531eg)* mutants and wild-type hermaphrodites. Specifically, no females were detected in a population of XX *tra-2(e2531eg)* animals ( $n >> 100$ ). However, given that all previously identified *tra-2* feminising mutations feminise the XX germ line (Doniach, 1986; Schedl and Kimble, 1988), it was important to determine whether *tra-2(eg)* mutations had any feminising effect on the XX germ line. Brood sizes were counted to investigate the possibility that the *tra-2(e2531eg)* mutation might partially feminise the XX germ line by reducing sperm number. The number of hermaphrodite self-progeny is limited by sperm number, so animals with a feminised germ line produce fewer self-progeny. XX *tra-2(e2531eg)* hermaphrodites were found to have a mean brood

**Table 1. Brood sizes of *tra-2(eg)* mutants**

Genotype	Viable	Inviabile	<i>n</i>
XX <i>tra-2(eg)</i>	323.3±22.5* (Range = 287-350)	0.8±0.98 (Range = 0-2)	6
XX <i>tra-2(eg); him-8†</i>	255.1±32.5 (Range = 192-313)	10.3±3.4 (Range = 6-16)	18
XO <i>tra-2(eg); him-8†</i>	0.3±0.5 (Range = 0-1)	14.1±14.6 (Range = 0-48)	9
XO <i>tra-2(eg) unc-4;</i> <i>dpy-26‡</i>	49.8±15.0 (Range = 27-68)	154.2±19.0§ (Range = 117-170)	6
XO <i>tra-2(eg); dpy-26</i>	35.5±16.0 (Range = 17-68)	107±19.0§ (Range = 80-138)	8
XO <i>tra-2(eg)unc-4;</i> <i>dpy-26 him-8‡</i>	31.7±11.7 (Range = 17-50)	141.3±20.0§ (Range = 117-173)	6
XO <i>tra-2(eg); dpy-26</i> <i>him-8</i>	35.3±14.0 (Range = 13-62)	125.6±15.4§ (Range = 107-144)	8

*n* = total number of broods counted.

\*XX wild-type N2 mean brood size is 330±34, for comparison (Hodgkin et al., 1979).

†~37% of *him-8* animals are predicted to be XO. Therefore, sibs have been subdivided into XX and XO, based on the observation that 30% of total animals have drastically reduced broods and hence are predicted to be XO.

‡*unc-4* is a gene closely linked to *tra-2* and is included as a phenotypic marker.

§Dead progeny consists of dead embryos, larval lethals and inviable Dpy animals, which are predicted to be XX and nullo-X in genotype.

size comparable to wild-type of 323.3±22.5 (*n*=6) (Table 1, line 1).

A further test for feminisation of the germ line was made by examining the *tra-2(e2531eg); fem-3(gf)* double mutant. *fem-3(gf)* mutations masculinise the XX germ line (sperm, no oocytes) at restrictive temperature, but not the soma (Barton et al., 1987). In contrast, *tra-2(gf)* mutations feminise the germ line (oocytes, no sperm) (Doniach, 1986; Schedl and Kimble, 1988). Double mutants carrying *fem-3(gf)* and *tra-2(gf)* reveal a balancing between the germ-line masculinising and feminising activities of these two genes, because a proportion of these animals are self-fertile (Barton et al., 1987). To test whether a similar interaction might occur between *tra-2(e2531eg)* and *fem-3(gf)*, the double mutant was constructed. To facilitate identification of the double mutant, this strain also carries the *unc-4* and *dpy-20* mutations as phenotypic markers closely linked to the *tra-2* and *fem-3* genes, respectively. XX *tra-2(e2531eg) unc-4; fem-3(gf) dpy-20* double mutants grown at restrictive temperature produced only sperm – none were self-fertile (*n*=120). Thus, the failure to detect any enhanced germ-line feminisation in *tra-2(eg)* mutants indicates that *tra-2(e2531eg)* activity remains sensitive to germ-line-specific regulatory controls normally present in XX hermaphrodites.

### ***tra-2(e2531eg)* activity requires wild-type *tra-3* activity**

The *tra-2* and *tra-3* genes are believed to function together to negatively regulate the activity of the *fem* genes (Fig. 1A). Loss-of-function mutations in either gene transform XX animals into non-mating pseudomales; however XX *tra-3* animals are less severely masculinised than XX *tra-2* animals (Hodgkin, 1980). Strong hypermorphic *tra-2(gf)* mutations, which presumably increase the level of wild-type TRA-2

proteins, can largely remove the requirement for *tra-3* activity (Doniach, 1986; Hodgkin, 1986). To test whether *tra-2(e2531eg)* can also function independently of *tra-3*, the phenotype of XX *tra-2(e2531eg) unc-4; tra-3* (*m<sup>-z</sup>*) homozygotes was examined. These animals are identical in phenotype to XX *tra-3* mutants (*n*=82), supporting the notion that *tra-2(eg)* activity is not hypermorphic because it still requires wild-type *tra-3* activity to promote XX hermaphrodite development.

### ***tra-2(e2531eg)* transforms XO males into self-fertile hermaphrodites**

To determine whether the *tra-2(e2531eg)* mutation, by itself, has XO feminising activity, the phenotype of *tra-2(e2531eg); him-8* animals was examined. All *tra-2(e2531eg); him-8* mutants examined were hermaphrodites (*n*>>100), although 37% of the progeny of XX *him-8* hermaphrodites would normally develop as XO males. This result establishes that XO *tra-2(eg)* mutants are hermaphrodites with normal regulation of *tra-2* germ-line activity and not females as are XO *tra-2(gf, eg)* double mutants. An example of a young adult XO *tra-2(e2531eg); him-8* hermaphrodite is shown in Fig. 3A (compare to XX hermaphrodite in Fig. 3B).

Brood sizes of twenty-seven *tra-2(e2531eg); him-8* siblings were counted to determine if XX and XO *tra-2(e2531eg); him-8* hermaphrodites produce similarly sized broods. 18/27 animals had a mean brood size of 255.1±32.5 (Table 1, line 2), which is within the range for XX *him-8* hermaphrodites (Hodgkin et al., 1979) and 9/27 animals had a mean brood size of 14 (range = 0-48 dead eggs and 0-1 viable). Given that 37% of *him-8* animals are predicted to be XO, the 9/27 hermaphrodites producing only 0-1 live progeny are presumed to be XO animals (Table 1, line 3).

### **Dominant feminisation of XO animals by *tra-2(e2531eg)***

To ask if a single dose of *tra-2(e2531eg)* feminises XO animals, *tra-2(e2531eg) unc-4* homozygotes were mated with wild-type XO males to produce heterozygous *tra-2(e2531eg) unc-4/+* cross-progeny. Half of the cross progeny were expected to be XO. All of the cross progeny were hermaphrodite (*n*=34), indicating that one dose of *tra-2(eg)* results in dominant feminisation of XO animals. However, the tails of 17 of the 34 animals were incompletely feminised (Fig. 4).

Two further experiments showed that the incomplete tail feminisation of *tra-2(e2531eg)/+* heterozygotes is limited to XO animals. First, XX *tra-2(e2531eg) unc-4* hermaphrodites were mated with sexually transformed XX *tra-2(q276)* males to produce XX *tra-2(eg)* heterozygotes. None of the XX *tra-2(e2531eg) unc-4/tra-2(q276)* heterozygotes had incompletely feminised tails (*n*=56), which correlates with the absence of XO animals. Second, *tra-2(e2531eg); unc-7* hermaphrodites were mated to wild-type XO males and their progeny examined. *unc-7* is an X-linked marker gene: XX *unc-7/+* heterozygotes are wild-type in phenotype, whereas XO hemizygotes are uncoordinated (Unc). The tails of all non-Unc XX hermaphrodites were fully feminised (*n*=47), whereas 31/41 Unc hermaphrodites, which were expected to be XO, had incompletely feminised tails. The remaining 10/41 Unc hermaphrodites had completely feminised tails and thus were likely to be XX self-progeny.

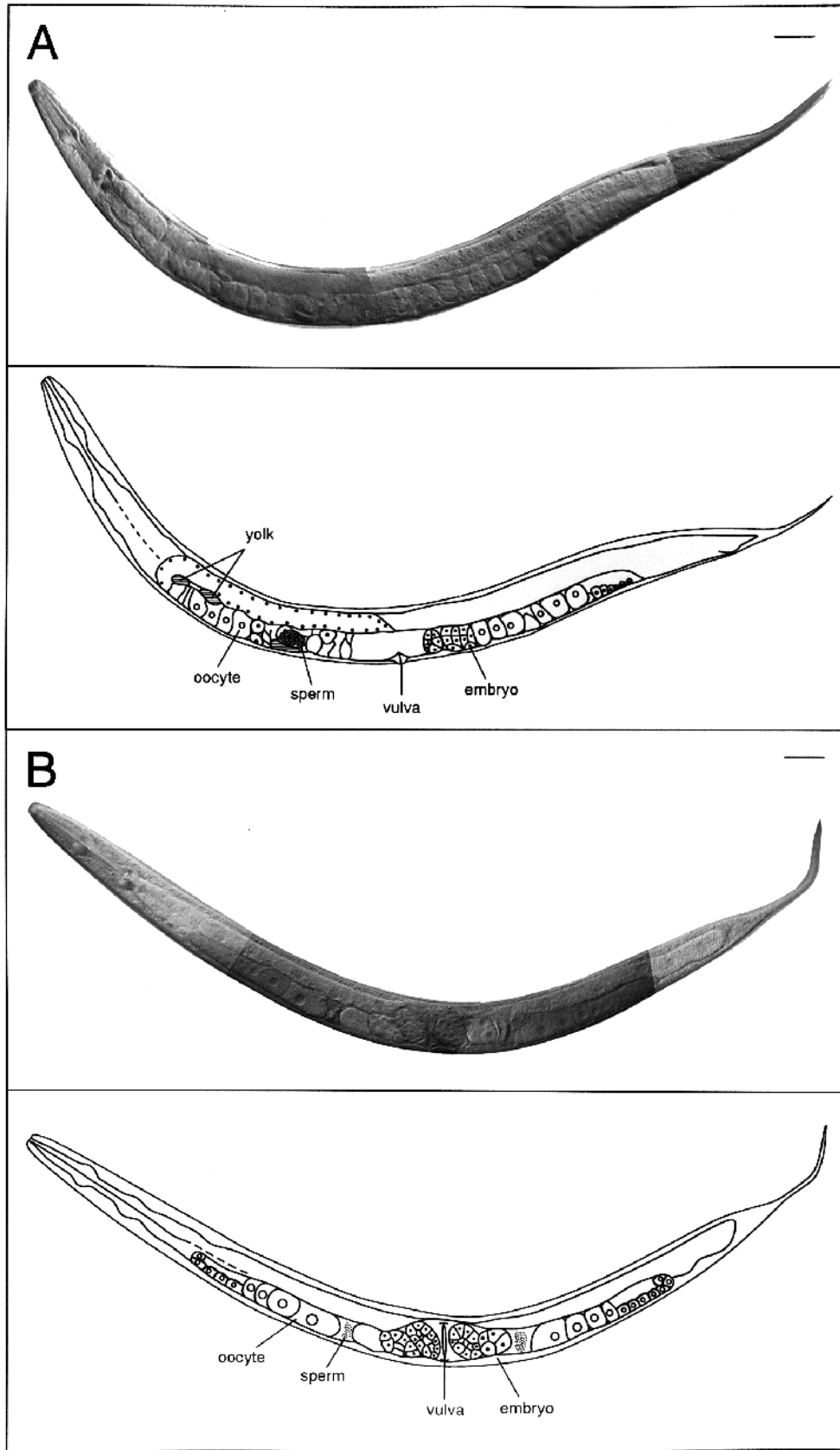

**Fig. 3.** XO *tra-2(eg)* mutants are transformed from male to hermaphrodite. (A) Top, Nomarski DIC photomicrograph (400×) of adult XO *tra-2(e2531eg)* hermaphrodite, lateral view. Bottom, schematic representation of photomicrograph. (B) Top, For comparison, Nomarski DIC photomicrograph (400×) of adult wild-type XX hermaphrodite, lateral view. Bottom, schematic representation of photomicrograph. Scale bar, 20 μm.

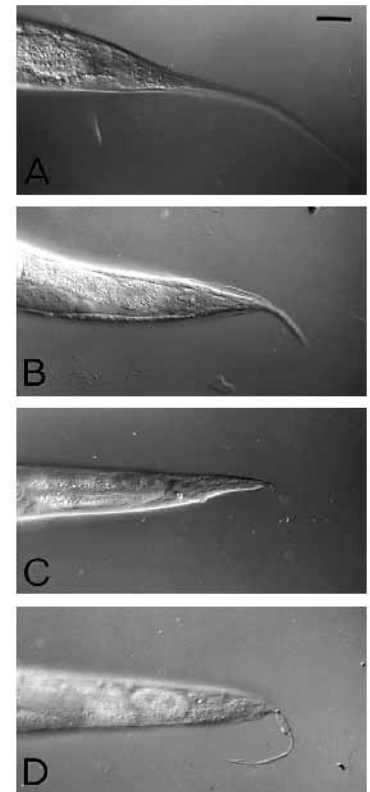

**Fig. 4.** Single-dose of *tra-2(eg)* produces incomplete tail feminisation of XO *tra-2(eg)/+* hermaphrodites. Nomarski DIC photomicrographs (400×). (A) Adult XX hermaphrodite tail spike, for comparison. (B-D) Adult XO *tra-2(e2531eg)/+* hermaphrodites showing incomplete tail feminisation, exemplified by truncated tail spikes (B-D) and swelling near anus (C). Scale bar, 10 μm.

**Table 2. Relative amounts of *tra-2* transcripts\***

	4.7 kb <i>tra-2</i>	1.8 kb <i>tra-2</i>	<i>myo-1</i>	$\frac{4.7 \text{ kb } tra-2}{myo-1}$	$\frac{1.8 \text{ kb } tra-2}{myo-1}$
XX wild-type	3.74	5.38	12.85	1.0†	1.45
XX <i>tra-2(e2531eg)</i>	7.32	12.5	21.8	1.28	1.97

\*Values (in arbitrary units) were determined by scanning laser densitometry of the northern blot in Fig. 6A,B, with an average of two to three scans through different regions of the indicated bands. Values for *myo-1* were determined after rehybridising the blot in Fig. 6A with a *myo-1* probe (Fig. 7B).

†The ratio of wild-type 4.7 kb *tra-2/myo-1* mRNA was set to equal 1.0. All other ratios are expressed as values relative to 1.0.

### ***tra-2(e2531eg)* activity is insensitive to *her-1(gf)* activity**

XO-specific *her-1* activity negatively regulates *tra-2* activity in males. The similarity between the XO *tra-2(eg)* and XO *her-1* mutant phenotypes suggests that *tra-2(eg)* activity is specifically insensitive to negative regulation by *her-1*. To test this hypothesis, the phenotypes of XX and XO *tra-2(e2531eg) unc-4; her-1(gf) him-5* mutants were examined. This strain carries the *her-1(gf)* mutation, which results in inappropriate expression of *her-1* mRNAs and makes it possible to examine the effect of elevated *her-1* activity in XX animals (Trent et al., 1991). It was found that all *tra-2(e2531eg) unc-4; her-1(gf) him-5* mutants are fully hermaphrodite ( $n \gg 100$ ); no partially or fully masculinised animals were detected, although these would normally be abundant in a population of animals carrying the *her-1(gf) him-5* double mutation. Therefore, the only difference between *tra-2(eg)* and wild-type *tra-2* activities in XX animals, so far detected, is that *tra-2(eg)* activity

can suppress inappropriate *her-1(gf)* masculinising activity and wild-type *tra-2* activity can not. All other aspects of wild-type *tra-2* function and regulation appear to be preserved in XX *tra-2(eg)* mutants.

### **The *tra-2(e2531eg)* mutation does not affect steady-state *tra-2* mRNA levels**

Northern blot analysis was used to compare steady-state *tra-2* mRNA levels in XX *tra-2(eg)* mutants to those found in wild-type hermaphrodites. As shown in Fig. 5, adult XX *tra-2(e2531eg)* and wild-type hermaphrodites each express a 4.7 kb and 1.8 kb *tra-2* mRNA, and no novel *tra-2* mRNAs are present in XX *tra-2(e2531eg)* hermaphrodites. Moreover, there is no significant difference in the levels of either the 4.7 kb or 1.8 kb *tra-2* mRNA in XX *tra-2(e2531eg)* or in wild-type hermaphrodites, after normalising for differences in sample loads (see Table 2; Materials and Methods). Therefore, the suppression of *her-1(gf)* by *tra-2(eg)* in XX animals is unlikely to result from increased *tra-2* mRNA steady-state levels, which might lead to increased TRA-2A protein, or from the expression of novel *tra-2* products. By the same logic, it is unlikely that elevated *tra-2* mRNA levels are responsible for transforming XO *tra-2(eg)* mutants into hermaphrodites, although *tra-2* mRNA levels have not been measured in XO *tra-2(eg)* mutants.

### **Potential interaction between the sex determination and dosage compensation pathways**

To test the possibility that improper activation of dosage compensation might be responsible for the low fertility of XO *tra-2(eg)* mothers, a *tra-2(e2531eg); dpy-26* strain was constructed. *dpy-26* animals are defective in dosage compensation: XX animals are dead or Dpy (dumpy) and XO animals are phenotypically wild type (Hodgkin, 1983; Plenefisch et al., 1989). Surprisingly, the fertility of XO *tra-2(e2531eg); dpy-26* ( $m^{-z^{-}}$ ) hermaphrodites was dramatically improved when compared to XO *tra-2(e2531eg)* hermaphrodites. The mean brood size of XO *tra-2(e2531eg); dpy-26* ( $m^{-z^{-}}$ ) hermaphrodites was increased from 14 (range = 0-48) to  $204 \pm 17.4$  ( $n=6$ ) (Table 1, compare line 3 to lines 4, 5). 1/4 of the brood developed into wild-type adults and 3/4 were dead or Dpy (Hodgkin, 1980). To show that the *him-8* mutation is not responsible for the low fertility of XO *tra-2(eg); him-8* mutants, the mean brood sizes of XO *tra-2(eg); dpy-26(m^{-z^{-})} him-8* and XO *tra-2(eg) unc-4; dpy-26(m^{-z^{-})} him-8* mutants were also determined. As shown in Table 1 (lines 6, 7), the *dpy-26* mutation still increases the fertility of XO *tra-2(eg)* mutants when the *him-8* mutation is present. It has been postulated that *dpy-26* mutations primarily affect XX animals and have no effect on XO animals (Hodgkin, 1983; Plenefisch et al., 1989). The finding that *dpy-26*

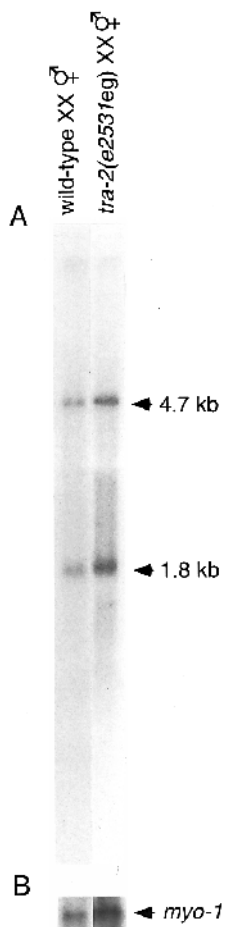

**Fig. 5.** The *tra-2(e2531eg)* mutation does not affect *tra-2* RNA splicing or steady-state mRNA levels. (A) Northern blot analysis of mRNA prepared from XX adult *tra-2(e2531eg)* and wild-type hermaphrodites. 3  $\mu$ g of poly(A)<sup>+</sup> mRNA is loaded per lane. Blot was hybridised with a <sup>32</sup>P-labelled probe that recognises all *tra-2* mRNAs (see Materials and Methods). The 4.7 kb and 1.8 kb *tra-2* mRNAs are indicated by arrows. (B) To normalise RNA loadings, the blot in Fig. 5A was rehybridised with a probe specific for pharyngeal *myo-1* (see Table 2). *myo-1* mRNA band is indicated.

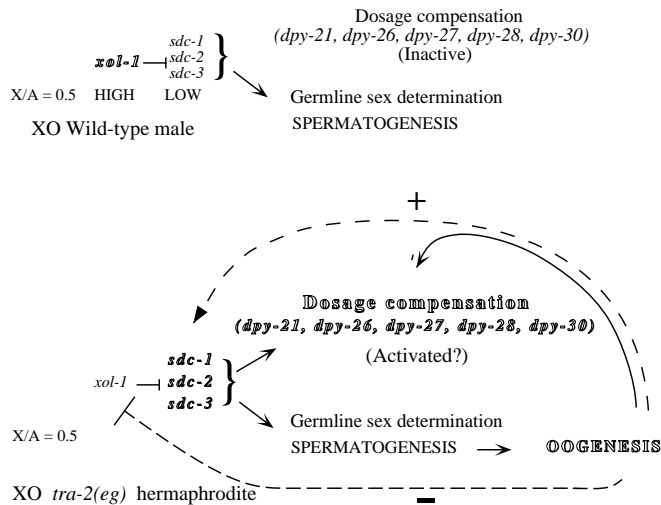

**Fig. 6.** Model proposing an interaction between the *C. elegans* pathways of germ-line sex determination and dosage compensation. Top, In wild-type XO animals, *xol-1* is active and functions to negatively regulate the *sdc* genes, thus preventing the activation of dosage compensation. These animals develop as males, which produce only sperm. Bottom, The dramatic increase in the fertility of XO *tra-2(e2531eg); dpy-26* double mutants suggests a potential interaction exists between the germ-line sex determination and dosage compensation pathways. In XO *tra-2(eg)* mutants, dosage compensation is predicted to be inactive, for the same reasons described above. Therefore, a mutation in a dosage compensation gene, *dpy-26*, is not predicted to affect XO *tra-2(eg)* hermaphrodites, if dosage compensation is already inactive. However, contrary to expectation, a *dpy-26* mutation improves the fertility of sexually transformed XO *tra-2(e2531eg)* mutants. This observation has led to the speculation that dosage compensation might be detrimentally activated in the germ line of feminised XO animals. Thus, the decision to undergo oogenesis in a feminised XO mutant may activate dosage compensation in the germ line, perhaps by feedback through the *sdc* genes (dashed arrow, activation) or *xol-1* (dashed line, inhibition). Alternatively, it may also be possible to directly activate the dosage compensation genes (solid arrow). In this model, the interaction between the germ-line sex determination pathway and the dosage compensation genes is predicted to circumvent the X:A ratio. Shadowed text indicates gene activity that is predicted to be high.

increases the fertility of XO *tra-2(e2531eg); dpy-26* ( $m^{-z^{-}}$ ) mutants suggests that there may be communication between the sex-determination and dosage compensation pathways (Figs 1, 6).

## DISCUSSION

### *tra-2(eg)* alleles define a novel class of *tra-2* feminising alleles that transforms XO males into hermaphrodites

The molecular basis of the *tra-2(eg)* mutation is distinct from that of previously characterised *tra-2(gf)* and *tra-2(mx)* feminising mutations (Goodwin et al., 1993; P. Kuwabara, P. Okkema and J. Kimble, unpublished). Each of ten *tra-2(eg)* mutants has been shown to carry an identical *tra-2* (G566A) base change, which is not present in their parent. By contrast,

the *tra-2(gf)* mutations disrupt a 28 nt repeat element in the 3' UTR (Kuwabara et al., 1992; Goodwin et al., 1993), and the *tra-2(mx)* mutations encode missense changes in a carboxy terminal domain of TRA-2A (P. Kuwabara, P. Okkema and J. Kimble, unpublished data).

Separation of the *tra-2(e2046gf, e2531eg)* double mutant by intragenic recombination also shows that, in XX animals, the *tra-2(e2531eg)* mutation, by itself, promotes entirely wild-type hermaphrodite development and, in combination with either a *fem-3(gf)* or *tra-3* mutation, reveals no enhanced feminising activity. By contrast, *tra-2* activity is deregulated and reveals gain-of-function character in XO *tra-2(eg)* mutants, which are transformed into self-fertile hermaphrodites, identical in phenotype to XO *her-1* mutants (Fig. 3A,B). In both XX and XO *tra-2(eg)* mutants, germ-line-specific controls of *tra-2* activity are retained. The sexual transformation of XO animals requires only a single dose of *tra-2(eg)*; however, the tails of XO heterozygotes are incompletely feminised, supporting the notion that the relative amounts of HER-1 and TRA-2A are critical to controlling sexual cell fate (Kuwabara and Kimble, 1995).

### The *tra-2(e2531eg)* mutation may identify a site that is essential for TRA-2A binding activity

The *tra-2(eg)* mutation affects only the 4.7 kb *tra-2* mRNA sequence (Fig. 2A), indicating that an alteration in the activity or regulation of TRA-2A is probably responsible for the feminisation of XO males. It has been shown that heat-shock-driven overexpression of TRA-2A transforms XO animals to hermaphrodites, presumably by titrating HER-1 (Kuwabara and Kimble, 1995). There is no evidence, however, that indicates *tra-2(eg)* activity is hypermorphic and feminises XO animals by titrating HER-1. First, there is no increase in the steady-state levels of *tra-2* mRNAs in *tra-2(eg)* mutants, which might lead to corresponding increases in TRA-2 proteins. Second, *tra-2(e2531eg)* activity remains dependent on wild-type *tra-3* activity, whereas strong hypermorphic *tra-2(gf)* mutations can function independently of *tra-3* (Hodgkin, 1986; Doniach, 1986). Third, unlike strong hypermorphic *tra-2(gf)* mutations (Goodwin et al., 1993), the *tra-2(eg)* mutation does not enhance germ-line feminisation.

A more plausible explanation is that the *tra-2(e2531eg)* mutation encodes a TRA-2A that is insensitive to negative regulation by HER-1. This is supported by the similarity between the XO *tra-2(eg)* and XO *her-1* mutant phenotypes, and also by the finding that inappropriate *her-1(gf)* activity fails to masculinise XX *tra-2(eg)* mutants. The simplest model postulates that TRA-2A (R177K) fails to bind HER-1, leaving TRA-2A (R177K) free to negatively regulate the FEM proteins and TRA-1 active (Fig. 1B). It remains possible that HER-1 binds to TRA-2A (R177K), but TRA-2A (R177K) fails to release the FEM proteins from inhibition. This might occur because HER-1 binds poorly and fails to induce an allosteric transition.

It may appear surprising that all ten *tra-2(eg)* mutations, which are known to be independent isolates, are identical. However, the generation of a *tra-2(eg)* mutation is probably a rare event, because *tra-2(eg)* mutants were not recovered in previous genetic screens. It could be argued that only a conservative amino acid change could disrupt a potential TRA-2A/HER-1 interaction and, at the same time, preserve all other aspects of normal TRA-2A function and regulation. This does



not mean that TRA-2A (R177) is the only site of potential contact between TRA-2A and HER-1; it may be the only site amenable to mutational analysis.

If the *tra-2(eg)* mutations define a HER-1 interaction site, then Arg 177 either participates directly in HER-1 binding or is crucial for TRA-2A to achieve a conformation that permits HER-1 binding. The TRA-2A (R177K) change might not be expected to interfere with HER-1 binding, because the positive charge is preserved. Nevertheless, there is good precedent: studies on the mannose 6-phosphate receptor (*MPR 46*) have shown that an R137K change results in a loss of ligand binding activity without affecting other receptor properties such as intramolecular disulphide bond formation, immunoreactivity, glycosylation and dimerisation (Wendland et al., 1991).

### Dosage compensation and gametogenesis

Dosage compensation equalises the levels of X-linked transcription between the sexes. In *C. elegans* this is probably achieved by down-regulating transcription of each X chromosome in XX hermaphrodites to half the level of the single X chromosome in XO males (for review, see Hsu and Meyer, 1993). In general, mutations in any one of the dosage compensation *dpy* genes have little or no effect on the phenotype or viability of XO animals. However, a mutation in a dosage compensation gene, *dpy-26*, greatly improves the fertility of XO *tra-2(e253leg)* hermaphrodites (Table 1, lines 4-7). XO *tra-2(e253leg); dpy-26* ( $m^{-z^{-}}$ ) mutants can be maintained as a self-propagating strain, whereas XO *tra-2(e253leg)* mutants can not. XO *her-1; dpy-26* ( $m^{-z^{-}}$ ) double mutants are also more fertile than XO *her-1* mutants (Hodgkin, 1983). Therefore, the increased fertility of sexually transformed XO hermaphrodites carrying a mutation in a dosage compensation gene might be a general phenomenon. Indeed, the original genetic selection for *tra-2(eg)* mutations was dependent on a mutation in another dosage compensation gene, *dpy-28* (Hodgkin and Albertson, 1995). One might speculate that the XO *tra-2(eg)* feminising mutations were not previously obtained because of the low fertility of sexually transformed XO *tra-2(eg)* mutants.

These observations indicate that *dpy-26*, and likely the other dosage compensation *dpy* genes, are active in a feminised XO *tra-2(eg)* mutant and have a detrimental effect on germ-line development. However, the dosage compensation genes can not be active throughout the animal. Otherwise, XO *tra-2(eg)* mutants would be expected to have a Xol phenotype (for Xol lethal), similar to that observed in XO *xol-1* mutants, which are inviable because the dosage compensation genes are active and inappropriately down-regulate the single X (Miller et al., 1988). The poor fertility of XO *tra-2(eg)* mutants might instead be explained by postulating that the XX program of dosage compensation has been activated, but only in the germ line. If so, then germ-line dosage compensation may be controlled by the decision to develop as an oocyte, not the X:A ratio. This could be achieved either by feedback through the *xol* and *sdc* genes or by a more direct pathway that bypasses these genes (Fig. 6). Relatively little is known about the role of the dosage compensation *dpy* genes in the germ line and it remains possible that they affect other processes not directly related to dosage compensation. Future experiments will explore the interactions between the *tra-2(eg)* mutation and the genes that regulate dosage compensation.

I thank J. Hodgkin for providing the *tra-2(gf, eg)* mutants and for sharing data prior to publication. I thank M. Bretscher, M. de Bono, J. Hodgkin and T. Schedl for critical reading of the manuscript and for helpful discussion. I am grateful to A. Lenton and B. Pashley for help with illustrations.

### REFERENCES

- Baird, S. E., Fitch, D. H. A. and Emmons, S. W. (1994). *Caenorhabditis vulgaria* Sp.N. (Nematoda: Rhabditidae): A necromenic associate of pill bugs and snails. *Nematologica* **40**, 1-11.
- Barton, M. K., Schedl, T. B. and Kimble, J. (1987). Gain-of-function mutations of *fem-3*, a sex-determination gene in *Caenorhabditis elegans*. *Genetics* **115**, 107-119.
- Brenner, S. (1974). The genetics of *Caenorhabditis elegans*. *Genetics* **77**, 71-94.
- Chirgwin, J. M., Przybyla, A. E., MacDonald, R. J. and Rutter, W. J. (1979). Isolation of biologically active ribonucleic acid from sources enriched in ribonuclease. *Biochemistry* **18**, 5294-5299.
- Doniach, T. (1986). Activity of the sex-determining gene *tra-2* is modulated to allow spermatogenesis in the *C. elegans* hermaphrodite. *Genetics* **114**, 53-76.
- Emmons, S. W. and Yesner, L. (1984). High frequency excision of transposable element Tc1 in the nematode *C. elegans* is limited to somatic cells. *Cell* **32**, 55-65.
- Goodwin, E. B., Okkema, P. G., Evans, T. C. and Kimble, J. (1993). Translational regulation of *tra-2* by its 3' untranslated region controls sexual identity in *C. elegans*. *Cell* **75**, 329-339.
- Heldin, C. H. (1995). Dimerisation of cell surface receptors in signal transduction. *Cell* **75**, 329-339.
- Hodgkin, J. (1980). More sex-determination mutants of *Caenorhabditis elegans*. *Genetics* **96**, 649-664.
- Hodgkin, J. (1983). X chromosome dosage and gene expression in *Caenorhabditis elegans*: two unusual dumpy genes. *Mol. Gen. Genet.* **192**, 452-458.
- Hodgkin, J. (1986). Sex determination in the nematode *C. elegans*: analysis of *tra-3* suppressors and characterization of *fem* genes. *Genetics* **114**, 15-52.
- Hodgkin, J. (1990). Sex determination compared in *Drosophila* and *Caenorhabditis*. *Nature* **344**, 721-8.
- Hodgkin, J. and Albertson, D. (1995). Isolation of dominant XO-feminising mutations in *Caenorhabditis elegans*: New regulatory *tra* alleles and an X chromosome duplication with implications for primary sex determination. *Genetics* **141**, 527-542.
- Hodgkin, J. and Brenner, S. (1977). Mutations causing transformation of sexual phenotype in the nematode *Caenorhabditis elegans*. *Genetics* **86**, 275-287.
- Hodgkin, J., Edgley, M., Riddle, D. and Albertson, D. G. (1988). Genetics appendix. In *The Nematode Caenorhabditis elegans* (ed. W. B. Wood and the Community of *C. elegans* Researchers), pp. 491-584. Cold Spring Harbor: Cold Spring Harbor Laboratory.
- Hodgkin, J., Horvitz, H. R. and Brenner, S. (1979). Nondisjunction mutants of the nematode *Caenorhabditis elegans*. *Genetics* **91**, 67-94.
- Horvitz, R., Brenner, S., Hodgkin, J. and Herman, R. (1979). A uniform genetic nomenclature for the nematode *Caenorhabditis elegans*. *Mol. Gen. Genet.* **175**, 129-133.
- Hsu, D. R. and Meyer, B. J. (1993). X chromosome dosage compensation and its relationship to sex determination in *C. elegans*. *Seminars in Dev. Biol.* **4**, 93-106.
- Hunter, C. P. and Wood, W. B. (1992). Evidence from mosaic analysis of the masculinizing gene *her-1* for cell interactions in *C. elegans* sex determination. *Nature* **355**, 551-555.
- Ingham, P. W., Taylor, A. M. and Nakano, Y. (1991). Role of the *Drosophila patched* gene in positional signalling. *Nature* **355**, 184-187.
- Kuwabara, P. E. and Kimble, J. E. (1992). Molecular genetics of sex determination in *C. elegans*. *Trends Genet.* **8**, 164-168.
- Kuwabara, P. E. and Kimble, J. (1995). A predicted membrane protein, TRA-2A, directs hermaphrodite development in *Caenorhabditis elegans*. *Development* **121**, 2995-3004.
- Kuwabara, P. E., Okkema, P. G. and Kimble, J. (1992). *tra-2* encodes a membrane protein and may mediate cell communication in the *Caenorhabditis elegans* sex determination pathway. *Mol. Biol. Cell* **3**, 461-473.

- Kyte, J. and Doolittle, R. F.** (1982). A simple method for displaying the hydropathic character of a protein. *J. Mol. Biol.* **157**, 133-148.
- Madl, J. E. and Herman, R. K.** (1979). Polyploids and sex determination in *Caenorhabditis elegans*. *Genetics* **93**, 393-402.
- Miller, D. M., Stockdale, F. E. and Karn, J.** (1986). Immunological identification of the genes encoding the four myosin heavy chain isoforms of *Caenorhabditis elegans*. *Proc. Natl. Acad. Sci. USA* **83**, 2305-2309.
- Miller, L. M., Plenefisch, J.D., Casson, L. P., Meyer, B. J.** (1988). *xol-1*: a gene that controls the male modes of both sex determination and X chromosome dosage compensation in *C. elegans*. *Cell* **55**, 167-183.
- Okkema, P. G. and Kimble, J.** (1991). Molecular analysis of *tra-2*, a sex determining gene in *C. elegans*. *EMBO J.* **10**, 171-176.
- Perry, M. D., Li, W., Trent, C., Robertson, B., Fire, A., Hageman, J. M. and Wood, W. B.** (1993). Molecular characterization of the *her-1* gene suggests a direct role in cell signaling during *Caenorhabditis elegans* sex determination. *Genes Dev.* **7**, 216-228.
- Plenefisch, J. D., DeLong, L. and Meyer, B. J.** (1989). Genes that implement the hermaphrodite mode of dosage compensation in *Caenorhabditis elegans*. *Genetics* **121**, 57-76.
- Sambrook, J., Fritsch, E. F. and Maniatis, T.** (1989). *Molecular Cloning: A Laboratory Manual*. Cold Spring Harbor, New York: Cold Spring Harbor Laboratory.
- Schedl, T. and Kimble, J.** (1988). *fog-2*, a germ-line-specific sex determination gene required for hermaphrodite spermatogenesis in *Caenorhabditis elegans*. *Genetics* **123**, 755-769.
- Sulston, J. E. and Hodgkin, J.** (1988). Methods. In *The Nematode Caenorhabditis elegans* (ed. W. B. Wood and the Community of *C. elegans* Researchers), pp. 587-606. Cold Spring Harbor: Cold Spring Harbor University Press.
- Trent, C., Purnell, B., Gavinski, S., Hageman, J., Chamblin, C. and Wood, W. B.** (1991). Sex-specific transcriptional regulation of the *C. elegans* sex-determining gene *her-1*. *Mech. Develop.* **34**, 43-56.
- Villeneuve, A. M. and Meyer, B. J.** (1990). The regulatory hierarchy controlling sex determination and dosage compensation in *Caenorhabditis elegans*. *Adv Genet* **27**, 117-88.
- Wendland, M., Waheed, A., von Figura, K. and Pohlmann, R.** (1991). Mr 46,000 mannose 6-phosphate receptor. *J. Biol. Chem.* **266**, 2917-2923.
- Zarkower, D. and Hodgkin, J.** (1992). Molecular analysis of the *C. elegans* sex-determining gene *tra-1*: a gene encoding two zinc finger proteins. *Cell* **70**, 237-249.

(Accepted 23 April 1996)