

# The T-box transcription factors TBX-37 and TBX-38 link GLP-1/Notch signaling to mesoderm induction in *C. elegans* embryos

Kathryn Good<sup>1,2,\*</sup>, Rafal Ciosk<sup>1,2,\*</sup>, Jeremy Nance<sup>1,2,\*</sup>, Alexandre Neves<sup>1,2</sup>, Russell J. Hill<sup>1,2,3</sup>, and James R. Priess<sup>1,2,4,†</sup>

<sup>1</sup>Division of Basic Sciences, Fred Hutchinson Cancer Research Center, Seattle, WA 98109, USA

<sup>2</sup>Howard Hughes Medical Institute, Seattle, WA 98109, USA

<sup>3</sup>Department of Molecular Genetics, The Ohio State University, Columbus, OH 43210, USA

<sup>4</sup>Department of Zoology, University of Washington, Seattle, WA 98195, USA

\*These authors contributed equally to this work

†Author for correspondence (e-mail: jpriess@fhcrc.org)

Accepted 22 January 2004

Development 131, 1967-1978

Published by The Company of Biologists 2004

doi:10.1242/dev.01088

## Summary

The four-cell *C. elegans* embryo contains two sister cells called ABa and ABp that initially have equivalent abilities to produce ectodermal cell types. Multiple Notch-mediated interactions occur during the early cell divisions that diversify the ABa and ABp descendants. The first interaction determines the pattern of ectodermal cell types produced by ABp. The second interaction induces two ABa granddaughters to become mesodermal precursors. We show that T-box transcription factors called TBX-37 and TBX-38 are essential for mesodermal induction, and that these factors are expressed in ABa, but not ABp,

descendants. We provide evidence that the first Notch interaction functions largely, if not entirely, to prevent TBX-37, TBX-38 expression in ABp descendants. Neither the second Notch interaction nor TBX-37, TBX-38 alone are sufficient for mesodermal induction, indicating that both must function together. We conclude that TBX-37, TBX-38 play a key role in distinguishing the outcomes of two sequential Notch-mediated interactions.

Key words: *C. elegans*, GLP-1, Notch, T-box, Mesoderm, Induction

## Introduction

The Notch signaling pathway is widely conserved in animal development, and is used in an enormous variety of cell fate decisions (for a review, see Artavanis-Tsakonas et al., 1999). In the development of the vertebrate vascular system alone, there are roles for Notch signaling in cell proliferation, cell migration, smooth muscle differentiation and arterial-venous differentiation (Iso et al., 2003). Notch signaling can act at multiple times within a single cell lineage to generate multiple cell types. For example, Notch signaling in *Drosophila* diversifies the daughters of the sensory organ precursor cell, then acts again at the following division to diversify each pair of granddaughters (Hartenstein and Posakony, 1990; Parks and Muskavitch, 1993). Notch-mediated cell interactions have been documented throughout the embryonic and post-embryonic development of *C. elegans*, with roles that include mesoderm development, choices between mitosis and meiosis, morphogenesis of the intestine, and development of the uterus and vulva (Greenwald et al., 1983; Austin and Kimble, 1987; Priess et al., 1987; Lambie and Kimble, 1991; Hutter and Schnabel, 1994; Mango et al., 1994a; Mello et al., 1994; Moskowitz et al., 1994; Hutter and Schnabel, 1995; Newman et al., 1995; Moskowitz and Rothman, 1996; Hermann et al., 2000). Notch-mediated interactions in *C. elegans* use one of two Notch-related receptors, called GLP-1/Notch and LIN-12/Notch, and various ligands such as APX-1/Delta or LAG-2/Delta. The expression patterns of these receptors and

ligands are remarkably complex and dynamic throughout development, and suggest that the long list of characterized Notch-mediated interactions remains incomplete.

Despite the importance of Notch signaling, little is known about how individual Notch-mediated interactions specify distinct cell fates at different times and places in development. The receptors GLP-1/Notch and LIN-12/Notch appear to be functionally equivalent, as are the ligands expressed by the various signaling cells (Fitzgerald et al., 1993; Fitzgerald and Greenwald, 1995; Gao and Kimble, 1995; Moskowitz and Rothman, 1996; Shelton and Bowerman, 1996). Moreover, all known examples of Notch signal transduction in *C. elegans* appear to involve a single transcriptional effector called LAG-1/Suppressor of Hairless [Su(H)] (Christensen et al., 1996). Thus, cell fate specificity must be achieved by factors that act in combination with Notch signaling.

At least four distinct interactions occur during the first few cell divisions of the *C. elegans* embryo, providing a relatively simple experimental system to analyze a network of Notch-mediated cell fate decisions (for a review, see Schnabel and Priess, 1997). The anterior cell in the two-cell stage embryo is called AB, and all of the early descendants of AB express the receptors GLP-1/Notch or LIN-12/Notch. Various AB descendants contact one of several ligand-expressing cells that are born at different times and places during the early divisions, and change their fate accordingly. In genetic studies of Notch-mediated, binary cell fate decisions, one cell fate can often be

considered as 'primary' and a second cell fate as 'secondary'; Notch function is required for the secondary, but not primary, fate (Artavanis-Tsakonas et al., 1999). In the absence of all Notch-mediated interactions in *C. elegans* embryos, AB descendants adopt highly patterned ectodermal fates that will thus be described here as primary fates.

The first Notch interaction occurs at the four-cell stage when the posterior daughter of AB, called ABp, contacts a cell called P<sub>2</sub> that expresses a Notch ligand (see Fig. 1). The interaction between P<sub>2</sub> and ABp causes the ABp descendants to adopt new fates that we describe here as secondary fates; cells with secondary fates remain ectodermal precursors, but have a pattern of differentiation that is distinct from cells with primary fates. The anterior daughter of AB, called ABa, does not contact P<sub>2</sub> and thus produces descendants that initially retain their potential for primary fates. At the 12-cell stage, however, two of the ABa granddaughters contact a new ligand-expressing cell called MS. This second Notch interaction induces those two ABa granddaughters to adopt novel, tertiary fates and become mesodermal precursors. During the next few cell divisions, there are third and fourth Notch interactions that further diversify the fates of some ABp descendants (see below

and legend to Fig. 1). Coincident with the Notch-mediated specification of cell fates, a separate anteroposterior polarity system generates additional differences between sister cells that are born from anteroposterior cell divisions. Thus, there are two types of primary fates (1a and 1p) depending on whether a cell is an anterior sister (1a) or posterior sister (1p; Fig. 1B). Similarly, there are two types of secondary fates and two tertiary fates (Fig. 1B). These anteroposterior differences appear to involve POP-1, a transcription factor that is localized asymmetrically after all anteroposterior divisions of the AB descendants (Kaletta et al., 1997; Lin et al., 1998; Park and Priess, 2003).

The mesodermal precursors that are induced by the second Notch interaction form the anterior half of the pharynx, a large muscular structure used in feeding (Sulston et al., 1983). The posterior half of the pharynx contains many of the identical mesodermal cell types found in the anterior half, but is derived from non-AB descendants through a Notch-independent pathway (Priess et al., 1987). Preventing the second Notch interaction results in embryos that lack the anterior pharynx, but that have a posterior half-pharynx produced by non-AB descendants (the Aph phenotype; anterior pharynx defective). Through genetic screens for Aph mutants, we identified two functionally redundant T-box transcription factors called TBX-37 and TBX-38 that are essential for the development of the anterior pharynx. We show that Notch signaling occurs at the 12-cell stage in *tbx-37 tbx-38* mutant embryos, but does not result in mesodermal specification. We further provide evidence that the primary, if not sole, function of Notch signaling at the four-cell stage is to repress TBX-37, TBX-38 expression in ABp descendants. Thus, the first Notch interaction restricts the expression of T-box proteins that are essential to couple the second Notch interaction to mesoderm development.

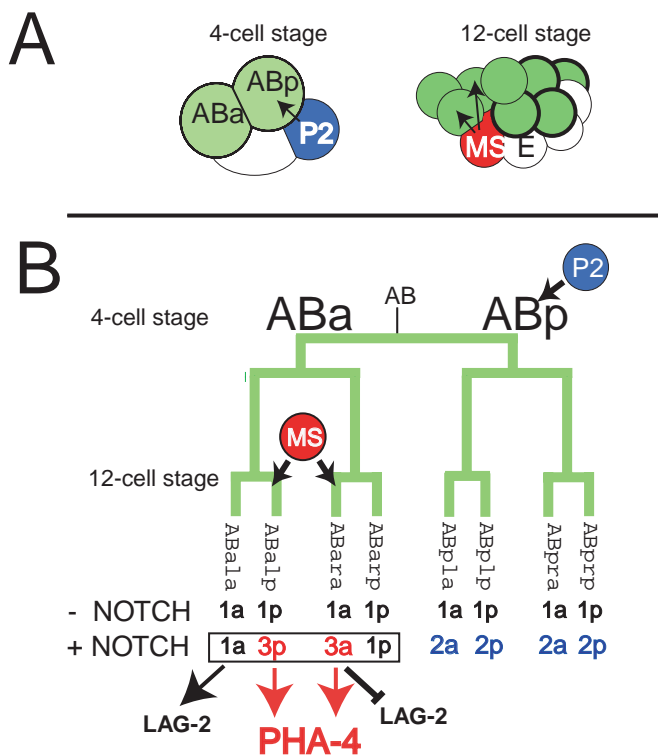

**Fig. 1.** Cell interactions that diversify AB descendants. (A) Four-cell and 12-cell embryos showing cells described in the text. ABa, ABp and their descendants each express GLP-1/Notch (green); ABp granddaughters at the 12-cell stage are outlined in bold. (B) Lineage diagram showing the first few divisions of ABa and ABp. Cell fates are shown in the absence of Notch signaling (– Notch) and when both the first (four cell) and second (12 cell) Notch interactions occur (+ Notch). The fates of the ABp descendants called ABp1a and ABp1p are further modified by the third and fourth Notch interactions, respectively (see Table 1). Signaling from MS leads to PHA-4 expression by the descendants of ABa1p and ABa2a, and in addition represses LAG-2 in ABa2a descendants.

## Materials and methods

### Nematode strains and maintenance

Nematodes were cultured and manipulated genetically as described by Brenner (Brenner, 1974). The following mutant alleles, chromosomal rearrangements and strains were used: *him-8(e1489)*, *skn-1(zu67)* (Bowerman et al., 1992), *qC1*, *tDf7*, *ctDf3*, *eDf20*, *dpy-18(e364)*, *spe-6(hc49)*, *apx-1(zu183)* and *lin-2(e1309)*. Strain BA607 is *spe-6(hc49) dpy-18(e364)/spe-6(hc49) dpy-18(e364)*; *eDp6 III. zuDf1*, *zuDf3*, *zuDf5*, *tbx-37(zu464)*, *tbx-37(zu466)*, *tbx-37(zu467)*, *tbx-38(zu460)* and *tbx-38(zu463)* were isolated in this study. The following transgenes were used: *lag-2::gfp* (Moskowitz and Rothman, 1996), *pha-4::gfp* (Alder et al., 2003) *tbx-37::gfp* and *tbx-38::gfp* (this study). Additional references for mutations listed above can be on the Wormbase web site (<http://www.wormbase.org>).

### Screens for Aph mutants

General procedures for isolating embryonic lethal mutants were as described elsewhere (Page et al., 1997). Mutations in *tbx-38* were isolated by mutagenizing *eDf20/qC1*; *lin-2(e1309)* animals. Candidate mutants were mated with *dpy-18(e364) spe-6(hc49)/qC1*; *lin-2(e1309)*; *him-8(e1489)* males. Recombinant *dpy-18(e364) tbx-38(mutant)/dpy-18(e364) spe-6(hc49)* animals were picked from the *eDf20 tbx-38(mutant)/dpy-18(e364) spe-6(hc49)* heterozygotes and allowed to self. Mutations in *tbx-37* were isolated by mutagenizing *dpy-18(e364)tbx-38(e460)* homozygous animals, and were then balanced with *qC1*. All *tbx-37* mutant strains were outcrossed two or more times using *dpy-18(e364) spe-6()/qC1*; *lin-2(e1309)*; *him-8(e1489)* males.

### Mapping deficiencies and identifying mutations in Tbx genes

Genomic DNA was amplified from single embryos as described (Muhlrad, 2002). To map regions deleted in deficiencies, dead eggs were collected from the progeny of deficiency heterozygotes and were used in single-embryo PCR reactions. Three sets of primers were used for each mapping experiment: an experimental primer set, a positive control set recognizing sequences on an intact chromosome, and a negative control set targeting a sequence known to be removed by the deficiency. Mutations within *tbx-37* and *tbx-38* were identified by amplifying and sequencing DNA from single Aph. Sequencing reactions were performed at the FHCRC core sequencing facility and were repeated at least once for each identified mutation.

### Transgene construction

Standard techniques were used to manipulate and amplify DNA. All transgene constructs were made using PCR fusion techniques (Hobert, 2002). To construct *tbx-37::gfp* and *tbx-38::gfp*, promoters (434 bp or 423 bp 5' of the start codons, respectively) were amplified and fused to *gfp*-coding sequences from plasmid pPD95.69 (1995 Fire lab vector kit, www.ciwemb.edu). In a second *tbx-38* fusion construct, a sequence beginning 423 bp 5' of the start codon and including the entire 1838 bp coding sequence was amplified and fused to *gfp*-coding sequence from the plasmid pPD95.75 (1995 Fire lab vector kit, www.ciwemb.edu). Predicted start codons for TBX-37 and TBX-38 were obtained from the Wormbase website (Wormbase web site, <http://www.wormbase.org>).

### Worm transformations

Purified yeast artificial chromosome Y47D3 was injected into *zuDf3/qC1* worms with a dominant *rol-6* co-transformation marker as described (Mello and Fire, 1995). Wild-type worms were injected with *tbx-37::gfp*, *tbx-38::gfp* or *tbx-38::tbx-38/gfp*, and a dominant *rol-6* co-transformation marker (Mello and Fire, 1995). The resulting extrachromosomal arrays were integrated by gamma-irradiation (Mello and Fire, 1995).

### Phenotypic and lineage analysis

One quarter of the self-progeny of *tbx-37(zu467) dpy-18(e364) tbx-38(zu460)/qC1* adult hermaphrodites are *tbx-37 tbx-38* mutant embryos. In experiments on fixed and stained embryos, mutant phenotypes were identified by examining all of the progeny. For analysis of live, early cells, mutant embryos were identified retrospectively after allowing each embryo to develop to terminal stage. For lineage analysis of mutant embryos, the marker *pha-4::gfp* was crossed into the parental strain. Embryos were selected for analysis that lacked GFP expression in the early ABa descendants.

### Antibodies

An artificial *tbx-38* cDNA was constructed by fusing each of the three predicted *tbx-38* exons after amplification by PCR. The *tbx-38* 'cDNA' was cloned into *HindIII* and *XhoI* sites of the pET-21b His-tag protein expression vector (Novagen). His-tagged TBX-38 was purified over a nickel column (QIAexpressionist kit, Qiagen) and injected into mice at the FHCRC Hybridoma Production Facility as described (Wayner and Carter, 1987). Hybridoma supernatants were assayed by immunostaining early embryos. Fixation and staining have previously been described (Lin et al., 1995).

## Results

### Identification of mutations in *tbx-37* and *tbx-38*

In large-scale screens for mutations in essential, embryonically expressed genes, we isolated only two candidate Aph mutants at a frequency far less than expected for typical loss-of-function mutations (Materials and methods). Both mutants

showed additional defects in cell division and differentiation that are not characteristic of Notch pathway mutants (data not shown). Genetic and physical mapping experiments showed that the strains contained non-complementing, large deficiencies of chromosome III; we name these deficiencies *zuDf1* and *zuDf3*. Both deficiencies lacked a common region of IIIIR that was ~8 map units or 0.8 Mb (Fig. 2A, bold line). Two previously described deficiencies, called *tDf7* and *ctDf3*, cover separate halves of this 8 map unit interval (Fig. 2A) (Muhlrad and Ward, 2002). Embryos homozygous for either *tDf7* or *ctDf3* did not have an Aph phenotype, suggesting that functionally redundant genes might be located within each half of the 8 map unit interval. Homology searches revealed only two candidate gene families with members in both halves; the first gene family can encode predicted glycosyltransferases, and the second family encodes T-box transcription factors named TBX-34, TBX-37, TBX-33 and TBX-38 (Wormbase web site, <http://www.wormbase.org>, release WS54, 2001).

We attempted to use dsRNA-mediated gene inhibition (RNAi) to examine each group of candidate genes, but failed to obtain Aph phenotypes in RNAi experiments on wild-type embryos, or on embryos that were homozygous for either the *tDf7* or *ctDf3* deficiencies. We next asked whether transgenes could rescue the Aph phenotype of *zuDf3* embryos. Partial phenotypic rescue was obtained with Y47D3, a yeast artificial chromosome with *C. elegans* DNA, including the T-box genes *tbx-34* and *tbx-37*. Based on this finding, we used *eDf20*, a small chromosomal deficiency that removes both *tbx-34* and *tbx-37*, in a second genetic screen for Aph mutants (Fig. 2A). This screen yielded three candidate Aph mutants, and each was shown by DNA sequencing to have a lesion in *tbx-38* (legend to Fig. 2). The mutant alleles *tbx-38(zu460)* and *tbx-38(zu463)* contain premature stop codons and are predicted to encode truncated, unstable proteins. The third allele, *zuDf5*, is a deletion that removes *tbx-38* and flanking genes. *eDf20* was removed from the mutant strains by recombination using a *dpy-18* mutation to mark the chromosome arm (Fig. 2A). Animals that were homozygous for either *dpy-18(e364) tbx-38(zu460)* or *dpy-18(e364) tbx-38(zu463)* produced viable embryos that grew into fertile adults (hatched embryos/total: 112/114 for *zu460* and 38/38 for *zu463*). We next mutagenized homozygous *dpy-18(e364) tbx-38(zu460)* animals in a third screen for Aph mutants, and recovered four candidate mutants. DNA sequencing of the *tbx-34* and (or) *tbx-37* genes from the mutant strains revealed three different mutations within *tbx-37* but none in *tbx-34* (Fig. 2). We conclude that *tbx-37* and *tbx-38* have redundant functions that are required for the development of the anterior pharynx. The T-box domains of TBX-37 and TBX-38 are most closely related to each other (83% amino acid identity), with lesser and comparable similarity to TBX-8 and TBX-9 in *C. elegans* (41%) and Tbx6 of mice (38%; Fig. 2B).

Embryos from each of the *tbx-37 dpy-18 tbx-38* triple mutant strains appeared essentially identical in the light microscope. The embryos had a well-differentiated posterior half-pharynx that was enclosed by a prominent basement membrane and that was attached to the intestine (bracketed region in Fig. 3B). In wild-type embryos, the apical surfaces of cells in the anterior and posterior halves of the pharynx can be visualized by immunostaining for adherens junctions (Fig. 3C). In the mutant embryos there was a gap in the staining pattern where the

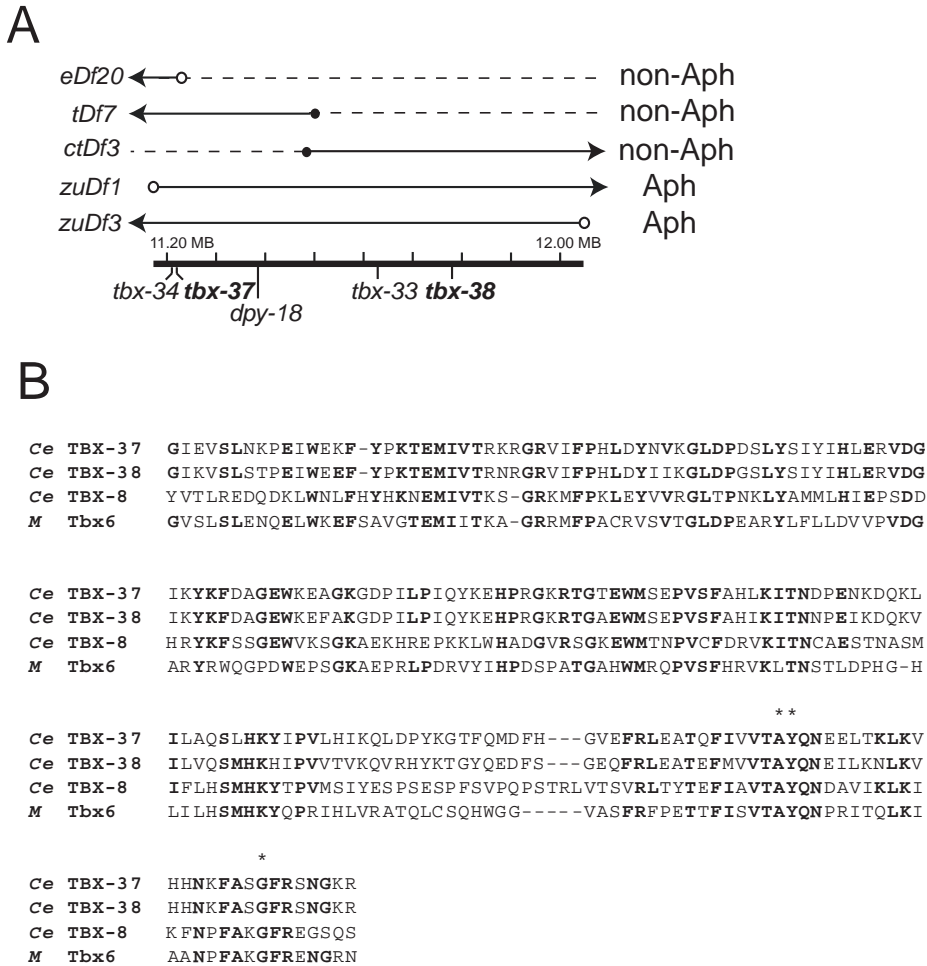

**Fig. 2.** *tbx-37* and *tbx-38* map positions and T-box DNA-binding domains. (A) Region from the right arm of chromosome III deleted by both *zuDf1* and *zuDf3*. Bold lines indicate DNA lacking in the various deficiency strains used. Terminal arrowheads indicate that the deficiency extends further than shown, black and white circles indicate defined and approximate deficiency breakpoints, respectively. The physical positions of listed genes are indicated in Mb according to the Wormbase web site (<http://www.wormbase.org>, release WS100, 2003). (B) The highly conserved T-box DNA-binding domain from mouse Tbx6 is shown with the corresponding domains from the *C. elegans* TBX-37, TBX-38 and TBX-8 proteins. The DNA-binding domains of TBX-37 and TBX-38 are nearly identical; residues shared between either of these proteins and TBX-8 or Tbx6 are shown in bold. Mutations in *tbx-37* are as follows with base changes underlined: *zu464* [glycine to glutamic acid change in DNA-binding domain (asterisk); GCCTCCGAATTC], *zu466* (premature stop in exon 4; GGAGCTTAAAAT) and *zu467* (5' splice site in intron 3; CAGATTGGGATT). Mutations in *tbx-38* are as follows: *zu463* [3' splice site in intron 2 (double asterisk); TTTCCAAAAC], *zu460* [deletion beginning at 5' splice site in intron 2 (double asterisk); AGGTTT//GACATA]; and *zuDf5* (deletion that removes *tbx-38* and the flanking genes).

anterior half of the pharynx would normally form (Fig. 3D). A rectum was visible at the posterior end of the intestine in most embryos (arrowheads, Fig. 3B,D). Embryos from all strains showed variable defects in body elongation; either the embryos ruptured along their ventral midline without elongating, or the embryos elongated into lumpy, mis-shapen worms (see below). Previous studies have shown that embryos defective in the GLP-1/Notch signaling pathway have duplications in right and left lateral skin cells called seam cells (Priess et al., 1987). We found defects in seam cell organization in all mutant embryos examined ( $n > 100$ ). Extra seam cells were present along the left lateral sides of almost all mutant embryos (compare Fig. 3F with Fig. 3E); however, the right lateral side either contained the normal number of seam cells or too few seam cells (see below). For a detailed analysis of the mutant phenotypes, we constructed the balanced strain *tbx-37(zu467) dpy-18(e364) tbx-38(zu460)/qC1* and examined embryos from these heterozygous adults; the homozygous *tbx-37(zu467) dpy-18(e364) tbx-38(zu460)* embryos are hereafter referred to as *tbx-37 tbx-38* mutant embryos.

#### ***tbx-37 tbx-38* mutant embryos fail to activate PHA-4 expression in the AB lineage**

The development of both the anterior and posterior halves of the pharynx requires PHA-4, a forkhead-class transcription factor (Horner et al., 1998; Kalb et al., 1998). In late stages of

embryonic development, PHA-4 is present in all of the pharyngeal nuclei, as well as in the intestinal and rectal nuclei (Fig. 4A) (Horner et al., 1998; Kalb et al., 1998). The intestinal and rectal expression of PHA-4 is controlled separately from pharyngeal expression, and is not discussed further here (see Kalb et al., 1998). In the second Notch interaction (at the 12-cell stage), the MS cell signals certain ABa descendants that respond by expressing PHA-4 and forming the anterior half of the pharynx. In addition to serving as a signaling cell for ABa descendants, MS itself is a mesodermal precursor. MS descendants express PHA-4 independent of Notch, and form the posterior half of the pharynx. If MS is killed before the second Notch interaction, no pharyngeal cells are produced (Hutter and Schnabel, 1994). If the MS daughters are killed after the second Notch interaction, the posterior half-pharynx fails to form, but an anterior half-pharynx develops from the induced ABa descendants (8/8 embryos; Fig. 4B,C).

PHA-4 appeared to be expressed in the wild-type pattern in the intestinal and rectal cells of *tbx-37 tbx-38* mutant embryos during morphogenesis (Fig. 4E). However, the head region contained approximately half the number of PHA-4-positive nuclei found in wild-type embryos, indicating that pharyngeal cells are missing rather than misplaced. After allowing MS to signal the ABa descendants at the 12-cell stage, we killed the MS daughters in embryos that were the self-progeny of heterozygous mutant hermaphrodites; one quarter of these

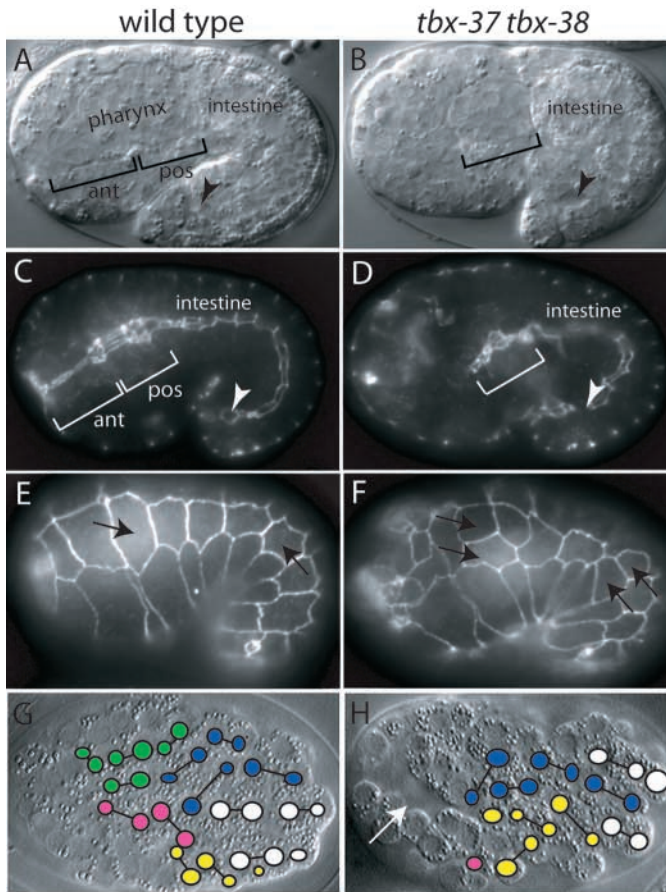

**Fig. 3.** Comparison of wild-type and *tbx-37 tbx-38* embryos. Left and right columns compare wild-type embryos and *tbx-37 tbx-38* embryos at identical stages with the same orientations. (A,B) Embryos undergoing morphogenesis, lateral view. Embryos are bent within the eggshell, head to the left and tail wrapped below the head. Anterior and posterior halves of the pharynx in A are indicated with brackets; the arrowhead indicates the rectum near the end of the tail. (C,D) Internal view of embryos immunostained for adherens junctions; labeling as above. (E,F) Surface view of embryos immunostained for adherens junctions. Note additional lateral cells (arrows) in the *tbx-37 tbx-38* embryo. (G,H) Dorsal view of embryos prior to morphogenesis. Clones of cells derived from each of the four ABarp granddaughters are colored as follows: ABarpaa (magenta), ABarpap (green), ABarppa (yellow), ABarppp (blue). Descendants of the C cell (white) are indicated for reference. White arrow in H indicates surface gap created by the abnormal ingressions of some ABarpaa and ABarpap descendants. All embryos are approximately 50  $\mu$ m in length.

embryos should have been homozygous for the *tbx-37 tbx-38* mutations. We found that 29% ( $n=23$ ) of the embryos had PHA-4 expression only in intestinal nuclei, indicating that they were unable to produce pharyngeal cell (Fig. 4F,G). Thus, the half-pharynx of *tbx-37 tbx-38* mutant embryos must originate entirely from MS descendants, as expected for a mutant defective specifically in Notch-mediated interactions. We observed the first five cell cycles of the MS lineage in *tbx-37 tbx-38* mutant embryos and found that the MS descendants showed the wild-type division rates and cleavage patterns ( $n=5$ , data not shown). For example, the MS descendant MSpaap

invariably underwent programmed cell death, as it does in wild-type embryogenesis. Later cell cycles were not examined directly. However, the partial pharynx in terminal-stage embryos contained two marginal cells and had a specialized cuticular surface called the grinder (9/9 embryos); both features are characteristic of the MS-derived, half-pharynx (data not shown) (Priess et al., 1987). These results together suggest that MS descendants undergo normal pharyngeal differentiation in *tbx-37 tbx-38* mutant embryos, but that ABA is unable to produce pharyngeal cells.

In wild-type embryos, PHA-4 expression begins in the early descendants of MS and ABA that are the precursors of pharyngeal cells (Horner et al., 1998; Kalb et al., 1998). We monitored PHA-4 expression in early embryogenesis with a *pha-4::gfp* transgene (Alder et al., 2003). Control embryos from wild-type animals that contained the transgene first showed PHA-4::GFP expression in the MS and ABA descendants at the 44-cell stage, one cell cycle earlier than reported previously for PHA-4 immunostaining (Horner et al., 1998; Kalb et al., 1998). PHA-4::GFP was detected in the four granddaughters of MS, and in the two anteriormost granddaughters of both ABalp and ABara (arrows in Fig. 4D, see also Fig. 1B). Unexpectedly, we occasionally observed a low level of PHA-4::GFP expression in the anterior two granddaughters of ABala (data not shown). ABala does not produce pharyngeal cells and is not thought to be signaled by MS; however, ABala descendants show transient contacts with the MS daughters. PHA-4::GFP expression did not persist in the ABala descendants in subsequent cell cycles and was not analyzed further.

We found that *tbx-37 tbx-38* mutant embryos at the 44-cell stage had normal PHA-4::GFP expression in the four MS granddaughters, but did not show PHA-4::GFP expression in any ABA descendant (arrows in Fig. 4H). Similarly, PHA-4::GFP expression was not detected in any of several ABA descendants that were monitored intermittently over the next three or four cell cycles. Thus PHA-4 expression is not initiated in the ABA descendants of *tbx-37 tbx-38* mutant embryos.

In addition to inducing PHA-4 expression, signaling from MS and GLP-1/Notch signal transduction have a second role in repressing the expression of the protein LAG-2 in ABA descendants (Moskowitz and Rothman, 1996). LAG-2 normally is expressed in the four granddaughters of ABala, a cell that does not contact MS, but is repressed in the four granddaughters of ABara, a cell that contacts MS (see Fig. 1B) (Moskowitz and Rothman, 1996). When MS signaling or GLP-1/Notch signal transduction are blocked, LAG-2 is expressed in each of the ABara granddaughters in addition to the ABala granddaughters. To examine whether MS signaling occurs in *tbx-37 tbx-38* mutant embryos, we crossed in a *lag-2::gfp* transgene (Moskowitz and Rothman, 1996). Similar to wild-type embryos, the ABala granddaughters expressed LAG-2::GFP in *tbx-37 tbx-38* mutants, but the ABara granddaughters did not (16/16 embryos; arrows in Fig. 5A). To confirm that MS signaling repressed LAG-2 expression in the ABara granddaughters, we used a laser microbeam to kill MS. All of the self-progeny of heterozygous *tbx-37 tbx-38*  $+/+$  hermaphrodites in which MS was killed had LAG-2::GFP expression in each of the ABara and ABala granddaughters (arrows in Fig. 5B;  $n=15/15$ ). We conclude that MS signaling

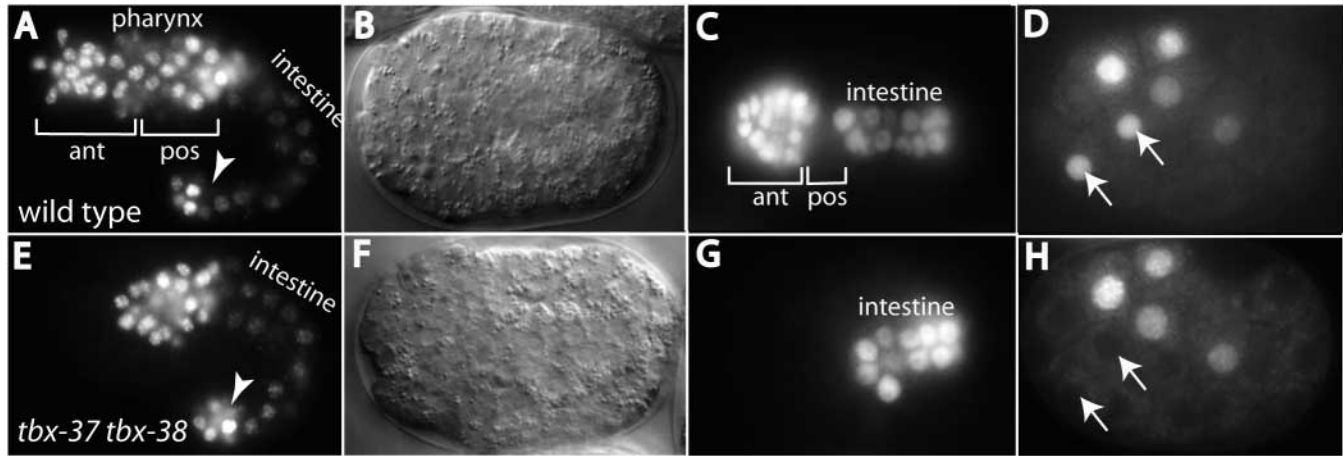

**Fig. 4.** PHA-4 expression in wild-type and *tbx-37 tbx-38* embryos. Wild-type and *tbx-37 tbx-38* embryos are shown in the top and bottom rows, respectively. (A,E) PHA-4::GFP expression at morphogenesis stages as shown and labeled in Fig. 3A,B. PHA-4 is present at high levels in all of the pharyngeal nuclei (brackets) and rectal nuclei (left of arrowhead in each panel), and present at lower levels in the intestinal nuclei. (B,F) Light micrographs of living embryos just prior to morphogenesis; the daughters of the MS cell were killed during early embryogenesis. (C,G) PHA-4::GFP expression in the embryos shown in B and F, respectively. In the wild-type embryo (B,C), cells in the anterior pharyngeal primordium (ant) and the intestinal cells express GFP, but the posterior pharyngeal primordium (pos) has not formed. In the *tbx-37 tbx-38* embryo (F,G), no pharyngeal cells are present. (D,H) PHA-4::GFP expression in 44-cell embryos. Both embryos show PHA-4::GFP in the MS granddaughters (top 4 GFP-positive nuclei) but only the wild-type embryo expresses PHA-4::GFP in ABA descendants (arrows indicate ABaraaa and ABarapa).

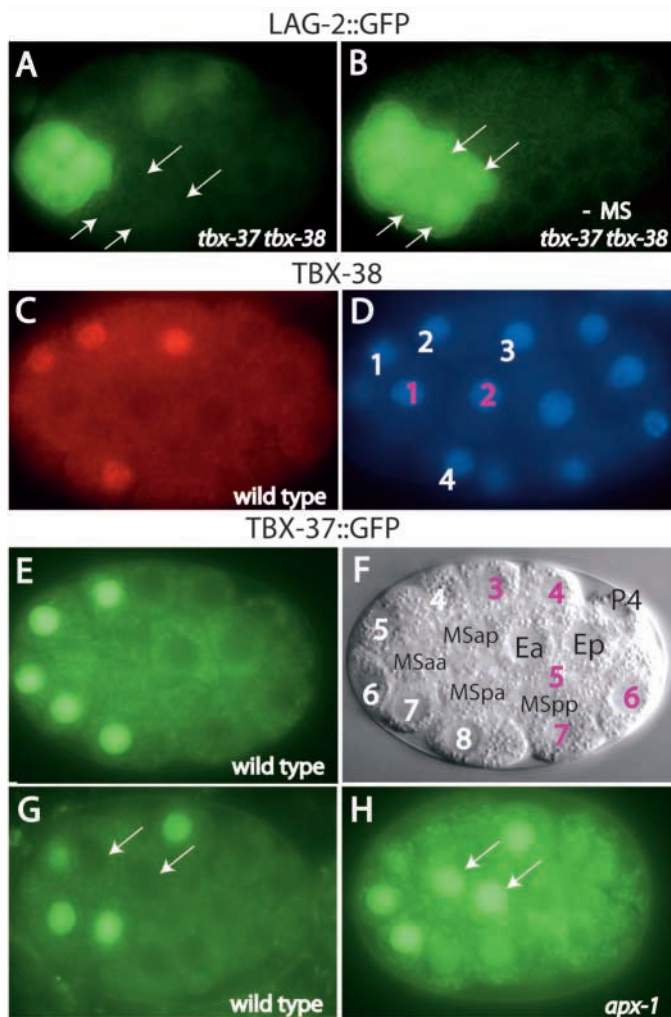

occurs in *tbx-37 tbx-38* mutant embryos and represses LAG-2, but that MS signaling does not result in PHA-4 expression.

#### Cell lineage analysis of *tbx-37 tbx-38* mutants

The above results demonstrate that *tbx-37 tbx-38* mutant embryos have defects in cell fates that normally are specified by the second Notch interaction. We wanted to determine whether these embryos had additional defects in any of the other three Notch-mediated interactions that diversify the early AB descendants (see Introduction). When these interactions fail to occur, some cells have well-characterized transformations in fate (Schnabel and Priess, 1997). To determine whether cells responded properly to the first Notch interaction (signaling from P2 to ABp at the four-cell stage), we used 4D videomicroscopy to examine the ABp granddaughter called ABplp (Table 1 and Fig. 1B). Each ABplp descendant examined had the wild-type pattern of division and differentiation. For example, the ABplp descendant ABplpppppp divides asymmetrically in wild-type

**Fig. 5.** LAG-2 and TBX-37 expression. (A,B) LAG-2::GFP expression in 44-cell *tbx-37 tbx-38* embryos with or without killing MS. Arrows indicate positions of the ABA granddaughters in both panels. (C,D) Wild-type 24-cell embryo stained with mAbT38 (C) and with DAPI to visualize nuclei (D). This dorsal view shows four ABA descendants (white numbers; 1, ABalpp; 2, ABarpa; 3, ABarp; 4, ABalpp) and two ABp descendants (magenta; 1, ABplaa; 2, ABplap). (E,F) Wild-type 26-cell embryo showing TBX-37::GFP expression (E) and viewed with Nomarski optics (F). This ventral view shows five ABA descendants (white; 4, ABalpp; 5, ABalpa; 6, ABalaa; 7, ABaraa; 8, ABarap) and five ABp descendants (magenta; 3, ABplpa; 4, ABplpp; 5, ABprpa; 6, ABprpp; 7, ABprap); additional cells from other lineages are labeled in black. (G,H) 26-cell wild-type (G) and *apx-1* mutant (H) embryos with the same dorsolateral orientation showing TBX-37::GFP expression. Two ABp descendants are indicated by arrows in both panels.

**Table 1. Lineage analysis of *tbx-37 tbx-38* mutant embryos**

Cell name	Cell fate	Cell fate	Cell fate
	<b>Wild type</b>	<b>-First Notch (-P2)</b>	<i>tbx-37 tbx-38</i>
<b>ABplp</b>			
ABplpppppp	Div<	Non div	Div<
ABplpppppa	Div	Non div	Div
ABplppppaa	Div	Non div	Div
ABplppppapp	Death	Non div	Death
<b>-Second Notch (-MS)</b>			
<b>ABalp</b>			
ABalppaaaa	Death	Hyp	Div
ABalppaapa	Death	Hyp	Div
ABalppppaap	Div	Hyp (predicted)	Div
ABalppppaaa	Div	Neuron (predicted)	Div
ABalppppaaap	Div	Hyp	Div
ABalppppapp	Div	Hyp	Div
ABalpppppap	Div	Hyp (predicted)	Div
ABalppppapp	Div	Hyp (predicted)	Death
<b>-Third Notch (-ABalapp)</b>			
<b>ABpla</b>			
ABplaaapp	Hyp	Div	Hyp
ABplaaappa	Hyp	Div	Hyp
ABplaaapp	Hyp	Div< ; death	Hyp
ABplaaapppp	Hyp	Hyp	Hyp
ABplaaappa	Hyp	Hyp	Hyp
<b>-Fourth Notch (-MSapa/p)</b>			
<b>ABplp</b>			
ABplpapp	Death	Div	Death
ABplpappaa	Div<	Div=	Div<
<b>-MS, -P2</b>			
<b>ABarp</b>			
(ABarppa)			
ABarpppppp	Hyp	Hyp	Div
ABarpppppa	Hyp	Hyp	Div
ABarppppaap	Hyp	Hyp	Div
ABarppppaaa	Div<	Div<	Div>
ABarppppaaap	Hyp	Hyp	Death
(ABarpppp)			
ABarppppppp	Hyp	Hyp	Hyp
ABarpppppppa	Hyp	Hyp	Hyp
ABarppppppap	Hyp	Hyp	Hyp
ABarppppppaa	Hyp	Hyp	Hyp
ABarppppppapa	Hyp	Hyp	Hyp
ABarpppppppaa	Div<	Div<	Div<
ABarpppppppaaap	Hyp	Hyp	Hyp

Various descendants of the ABA and ABp granddaughters (left column, bold type) were examined in *tbx-37 tbx-38* mutants. The wild-type fates of the cells selected for analysis are dependent on one or more of the four Notch-mediated interactions. For comparison, the fate of each cell analyzed is shown for wild-type embryos (data from Sulston et al., 1983) and shown for mutant or experimental embryos where one of the four Notch-mediated interactions does not occur [observed and predicted data from (Hutter and Schnabel, 1994; Hutter and Schnabel, 1995)]. Cell fates were determined in at least two, and usually three, embryos. Cell behaviors were scored as follows: Div (divides equally); Div< (divides unequally with smaller anterior daughter); Div> (divides unequally with larger anterior daughter); Hyp (differentiates as a hypodermal/skin cell); and Death (cell undergoes programmed cell death).

embryos and in *tbx-37 tbx-38* mutants, but does not divide when P2 signaling is prevented. Thus, the *tbx-37 tbx-38* genes do not appear to be essential for the first Notch interaction that induces secondary fates in ABp descendants.

The fates of some ABpla and ABplp descendants are further diversified by the third and fourth Notch interactions, respectively (Table 1) (see Hutter and Schnabel, 1995;

Moskowitz and Rothman, 1996). In the third interaction, an ABA descendant called ABalapp becomes a new signaling cell that activates Notch in a subset of adjacent ABpla descendants. We examined the development of some of these ABpla descendants in *tbx-37 tbx-38* mutant embryos and found that they had the wild-type pattern of differentiation (Table 1). For example, in both mutant and wild-type embryos, ABplaaapp

differentiated as a hypodermal cell, while this same cell continues to divide if the third Notch interaction does not occur.

In the fourth Notch interaction, certain descendants of the MS cell (MSapa or MSapp) become new signaling cells that activate Notch in adjacent ABplp descendants (Moskowitz and Rothman, 1996). We found that these ABplp descendants appeared to differentiate normally in *tbx-37 tbx-38* mutant embryos (Table 1). For example, some of these descendants became the excretory cell or formed the rectum, both of which are visible in most *tbx-37 tbx-38* mutant embryos (Fig. 3B, arrowhead). Thus, three out of the four early, Notch-mediated interactions appear to occur normally in *tbx-37 tbx-38* mutant embryos.

We next examined the cell lineages of several ABA descendants whose fates are determined by the second Notch interaction (signaling from MS to ABalp and ABara at the 12-cell stage; Fig. 1B). Although the development of ABalp was highly abnormal in the *tbx-37 tbx-38* mutant embryos, the defects did not match the abnormalities seen when MS signaling is prevented (Table 1). For example, in wild-type embryos, ABalpppaaaa undergoes programmed cell death, and this same cell differentiates without dividing when MS signaling is prevented. However, this cell did not undergo programmed cell death or differentiate in the *tbx-37 tbx-38* mutant embryos, and instead continued to divide. Thus, *tbx-37 tbx-38* embryos have lineage defects in cell types normally specified by MS signaling, although the defects do not match those expected from a simple loss of Notch signal transduction.

To determine whether the *tbx-37* and *tbx-38* genes have a role in the ABA descendants that are not signaled by MS, we examined the development of ABarp (Fig. 1B). In wild-type embryogenesis, each ABarp granddaughter generates a clone of cells that is located on the dorsal surface of the embryo; most of these cells will form the hypodermis or skin of the embryo (Fig. 3G, see legend for color code). In the *tbx-37 tbx-38* mutant embryos, most of the descendants of ABarpaa (magenta) and all of the descendants of ABarpap (green) ingressed into the body cavity rather than remaining on the dorsal surface (Fig. 3H). These abnormal cell ingressions created transient gaps on the dorsal surface (Fig. 3H, arrow). Similar gaps occur only on the ventral surface of wild-type embryos, as cell ingressions normally are restricted to the ventral surface (Nance and Priess, 2002). In wild-type embryos, the clones generated from the sister cells ABarppa (blue) and ABarppp (yellow) separate from each other to form left and right lines of skin cells on the lateral surfaces of the body (Fig. 3G) (Sulston et al., 1983). These clones did not separate normally in any of three *tbx-37 tbx-38* embryos analyzed (Fig. 3H); this defect probably contributes to the abnormal numbers of seam cells observed on the lateral sides of terminal *tbx-37 tbx-38* embryos (Fig. 3F). Although the sister cells ABarppa and ABarppp normally have identical fates, only ABarppa was markedly abnormal in *tbx-37 tbx-38* embryos (see Discussion). In conclusion, *tbx-37 tbx-38* mutant embryos have defects in multiple ABA descendants irrespective of whether or not these cells undergo the second Notch interaction (MS signaling). By contrast, the *tbx-37 tbx-38* embryos do not appear to have defects in any of the ABp descendants examined.

### TBX-37 and TBX-38 are expressed in ABA, but not ABp descendants

To assay TBX-37 and TBX-38 expression, a monoclonal antibody (mAbT38) was generated against a full-length TBX-38 fusion protein, and *tbx-7::gfp*, *tbx-38::gfp* and *tbx-38::tbx-38/gfp* transgenes were constructed and integrated into chromosomes (Materials and methods). mAbT38 did not stain *tbx-37 tbx-38* mutant embryos (data not shown), but showed strong staining of nuclei in 24-cell wild-type embryos (Fig. 5C). At the 24-cell stage, there are eight descendants of ABA and eight descendants of ABp; only the eight ABA descendants expressed TBX-38 (Fig. 5C; cells identified in Fig. 5D). Staining diminished markedly in the ABA descendants during the next cell cycle, with very little or no staining visible thereafter (data not shown). Similarly, the *tbx-37::gfp* and *tbx-38::gfp* transgenic embryos had GFP expression exclusively in the eight ABA descendants at the 24-cell stage (Fig. 5E,G and data not shown). Although antibody staining suggested that endogenous TBX-38 is an extremely short-lived protein, TBX-38::GFP persisted in all of the ABA descendants throughout most of embryogenesis (data not shown).

We asked whether signaling from MS induced the expression of the TBX-37, TBX-38 proteins in ABA descendants. Killing MS with a laser microbeam did not prevent TBX-38::GFP expression in any of the ABA descendants (8/8 experiments). Similarly, RNAi-mediated depletion of LAG-1, the transcriptional effector of GLP-1/Notch, did not alter the pattern of TBX-37::GFP expression in ABA descendants (27/27 embryos with terminal *lag-1* phenotypes). Thus, MS signaling and Notch signal transduction are not required for TBX-37, TBX-38 expression in ABA descendants.

We wanted to determine whether SKN-1, a maternally provided transcription factor, had a role in TBX-37, TBX-38 expression. SKN-1 is required for PHA-4 expression and mesoderm development, both through the Notch-dependent pathway (anterior pharynx produced by ABA descendants) and Notch-independent pathway (posterior pharynx produced by MS descendants) (Bowerman et al., 1992). SKN-1 is present at high levels in MS, and at lower levels in ABA and ABA descendants (Bowerman et al., 1993). We crossed the *tbx-37::gfp* transgene into a *skn-1(zu67)* mutant strain and found that each of 17 *skn-1* mutant embryos examined showed the wild-type pattern of GFP expression in ABA descendants at the 24-cell stage. Thus, mutations in *skn-1* do not appear to prevent ABA descendants from producing mesoderm by blocking the expression of TBX-37. This result is consistent with previous evidence that SKN-1 does not regulate the competence of ABA descendants to respond to MS signaling, but may instead regulate some aspect of MS signaling (Shelton and Bowerman, 1996).

We next asked whether TBX-37, TBX-38 was repressed in ABp descendants by signaling from P<sub>2</sub>. For this experiment, the *tbx-37::gfp* transgene was crossed into an *apx-1(zu183)* mutant strain; *apx-1* encodes the P<sub>2</sub> ligand for GLP-1/Notch. We found that all of the 24-cell embryos examined showed TBX-37::GFP in both ABA and ABp descendants (27/27 embryos; Fig. 5H). Similarly, both ABA and ABp descendants expressed TBX-37::GFP in many embryos where LAG-1 was depleted by RNAi (14/22 embryos; data not shown). Therefore TBX-37 expression is prevented in ABp descendants by P<sub>2</sub> signaling and by GLP-1/Notch signal transduction.



### Loss of *tbx-37 tbx-38 (+)* activity suppresses posterior defects in *apx-1* mutants

In the absence of Notch-mediated interactions, ABp descendants adopt primary fates instead of their normal secondary fates. We have shown here that preventing the first Notch interaction causes ABp descendants to express TBX-37, TBX-38 inappropriately. Moreover, TBX-37, TBX-38 functions appear to contribute to primary fates, because the development of ABarp (primary fate 1p) is abnormal in *tbx-37 tbx-38* mutant embryos (Fig. 1B). These findings together raise the possibility that the first Notch interaction might in part permit normal ABp development by preventing TBX-37, TBX-38 expression. To test this possibility, we constructed and analyzed *apx-1; tbx-37 tbx-38* triple mutant embryos. In wild-type embryos, ABp descendants contribute predominately to posterior body morphology, these descendants form tail structures including the rectum, tail spike and ventral hypodermis (Sulston et al., 1983). *apx-1* mutants defective in the first Notch interaction, and *glp-1* mutants defective in both the first and second Notch interactions, do not undergo posterior body morphogenesis and lack each of these posterior features (Fig. 6A) (Mello et al., 1994). Remarkably, we found that late stage *apx-1; tbx-37 tbx-38* triple mutant embryos had a well-formed tail including a rectum (Fig. 6B, large arrow) and a tail spike (insert, Fig. 6B). At earlier morphogenesis stages, these embryos had a group of ventral hypodermal cells that appeared identical to the wild-type ABp descendants in pattern and number (compare Fig. 6C with 6D). As expected, the heads of the triple mutant embryos contained only a partial pharynx and had variable anterior defects similar to those of the *tbx-37 tbx-38* double mutant embryos. We did not perform a detailed lineage analysis of the triple mutant embryos. However, the normal appearance of posterior, ABp-derived structures argues that the first Notch interaction is largely, if not entirely, dispensable if TBX-37, TBX-38 function(s) are prevented in ABp

## Discussion

### MS induction of mesodermal cell fates

During the 12-cell stage of *C. elegans* embryogenesis, Notch-mediated signaling from MS induces a subset of ABa

descendants to express PHA-4 and become mesodermal precursors. We have shown here that two, functionally redundant T-box transcription factors called TBX-37 and TBX-38 are essential for the ABa descendants to become mesodermal precursors. Several examples of T-box proteins with roles in mesodermal development have been described, including the prototype member Brachyury (for a review, see Papaioannou et al., 1998). Our present study provides evidence that TBX-37, TBX-38 must act in conjunction with unidentified targets of the Notch signal transduction pathway for mesodermal induction in *C. elegans*. First, we have shown that TBX-37, TBX-38 expression and Notch signal transduction are regulated independently in ABa descendants. Killing the signaling cell, MS, or removing LAG-1, the transcriptional effector of the Notch pathway, does not prevent TBX-37, TBX-38 expression in ABa descendants. Conversely, removing TBX-37, TBX-38 does not prevent Notch-mediated repression of LAG-2 in the ABara granddaughters. Second, we have shown neither Notch signal transduction nor TBX-37, TBX-38 alone are sufficient for mesodermal induction. All of the early ABa descendants express TBX-37, TBX-38 in wild-type embryos, but only those ABa descendants that are signaled by MS become mesodermal precursors. Conversely, activation of Notch represses LAG-2 expression in the ABara granddaughters of *tbx-37 tbx-38* embryos, but does not induce PHA-4 expression in those same cells.

Although the second Notch interaction (MS signaling) induces cells to become mesodermal precursors that form the pharynx, the first Notch interaction (P<sub>2</sub> signaling) prevents cells from becoming mesodermal precursors. If the first Notch interaction does not occur, embryos have a hyperinduction of pharyngeal tissue (Fig. 6A) (Hutter and Schnabel, 1994; Mello et al., 1994; Mango et al., 1994a; Moskowitz et al., 1994). In normal development, MS signaling induces ABa, but not ABp, descendants to become mesodermal precursors (black arrows from MS in Fig. 7A). However, MS and its sister cell, called E, both have the ability to signal, and one or both of these cells contact some ABp descendants in addition to contacting ABa descendants (gray arrows from MS in Fig. 7A) (Lin et al., 1998). When P<sub>2</sub> signaling is blocked, either by physically removing P<sub>2</sub> or by mutations in the P<sub>2</sub> ligand encoded by *apx-1*, MS and E induce these additional ABp descendants to

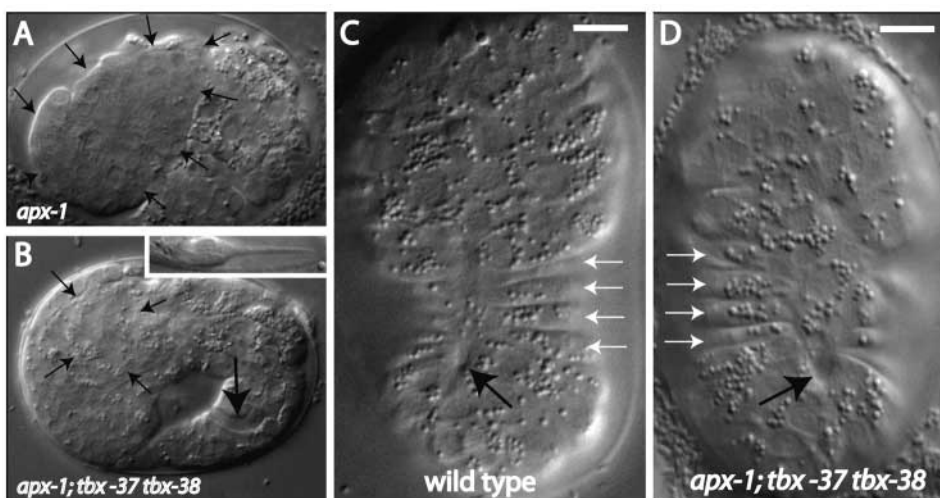

**Fig. 6.** ABp development. (A) *apx-1* mutant embryo showing the lack of body morphogenesis and the massive pharynx (outlined by arrows) caused by the hyperinduction of both ABa and ABp descendants to become mesodermal cells. (B) *apx-1; tbx-37 tbx-38* embryo with a small, half-pharynx (small arrows), a tail, a rectum (large arrow) and a tail spike (inset). (C,D) Ventral views of wild-type and *apx-1; tbx-37 tbx-38* embryos at the onset of morphogenesis showing ventral hypodermal cells (white arrows) and the nascent rectum (black arrow). Scale bar: 5  $\mu$ m.

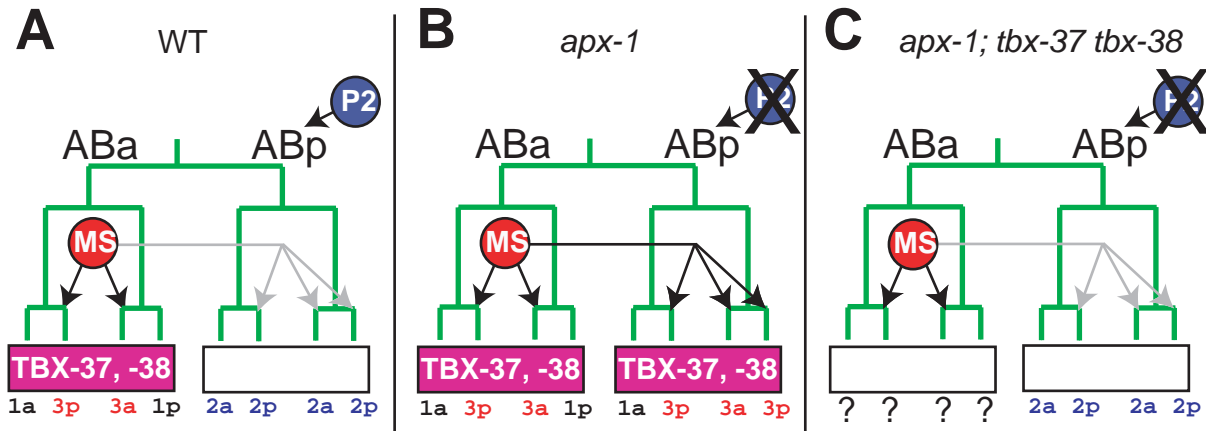

**Fig. 7.** TBX-37, TBX-38 expression and the first and second Notch interactions. Schematic diagrams of ABA and ABp development in wild-type embryos, *apx-1* embryos, and *apx-1; tbx-37 tbx-38* mutant embryos. (A) Arrows extending from MS indicate ABA and ABp descendants that contact MS or its sister, E (not shown). (B) When ABA or ABp descendants express TBX-37, TBX-38 and are signaled by MS or E, they adopt the tertiary fates shown and become mesodermal precursors. (C) The ABp descendants are assumed here to adopt secondary fates in the *apx-1; tbx-37 tbx-38* mutant embryos because these embryos form tails. Fates of ABA descendants presumably are the same as in *tbx-37 tbx-38* mutant embryos, but were not examined directly (indicated by ?).

become mesodermal precursors (black arrows from MS in Fig. 7B). We have shown that mutations in *apx-1* cause the inappropriate expression of TBX-37, TBX-38 in ABp descendants. In addition, we have shown that removing TBX-37, TBX-38 activities from *apx-1* mutant embryos prevents the hyperinduction of pharyngeal cells (Fig. 7C; Fig. 6B). Thus, the competence of both ABA and ABp descendants to become mesodermal precursors in response to the second Notch interaction is determined by the pattern of expression of TBX-37, TBX-38.

### Notch signaling and T-box transcription factors

The *C. elegans* genome contains 20 predicted T-box genes, and *tbx-37* and *tbx-38* are located within a divergent branch of 13 genes that lack clear orthologs in other species (Ruvkun and Hobert, 1998) (WormBase web site, <http://www.wormbase.org>, release WS110, 2003). The T-box DNA binding domains of TBX-37, TBX-38 show the highest, although moderate, similarity to the domains from *C. elegans* TBX-8 and mouse Tbx6 (Fig. 2B). Tbx6 is expressed in presomitic mesoderm; mice lacking Tbx6 fail to produce posterior somites, while mice with reduced levels of Tbx6 produce somites with defective rostrocaudal patterning (White et al., 2003; Chapman and Papaioannou, 1998). Defects in Notch signaling result in somitic defects that are very similar to defects created by reducing Tbx6 levels. However, Tbx6 may function upstream of the Notch pathway in mice because animals with reduced levels of Tbx6 show reduced levels of a ligand for Notch.

Genetic studies have been reported on only two T-box family members in *C. elegans*, *mab-9* and *mls-1* (Chisholm and Hodgkin, 1989; Woollard and Hodgkin, 2000; Kostas and Fire, 2002). MAB-9 is required to pattern the posterior hindgut; in *mab-9* mutants, posterior blast cells in the hindgut adopt characteristics of their anterior neighbors (Chisholm and Hodgkin, 1989). MLS-1 has a role in specifying muscle cell types; mutations in *mls-1* cause presumptive uterine muscle precursors to differentiate as vulval muscles (Kostas and Fire, 2002). The cell fate decisions mediated by MAB-9 and MLS-

1 are not known to involve Notch signaling directly, although Notch signaling has roles both before and after the events that differentiate uterine from vulval muscles.

An important task of future studies is the identification of the Notch target(s) that function in conjunction with TBX-37, TBX-38 to activate PHA-4 expression. Signaling from MS begins sometime during the 12-cell stage. Because the interval between the 12-cell and 24-cell stages is only 16 minutes, it is likely that Notch targets are transcribed and translated late in the 12-cell stage or early in the 24-cell stage. TBX-37, TBX-38 are expressed at the 24-cell stage, suggesting that TBX-37, TBX-38 may be co-expressed with direct Notch targets. There are several possibilities for how these proteins might interact directly or indirectly. Recent studies have provided examples of T-box proteins that bind to other proteins to control tissue differentiation. These partners include GATA transcription factors, homeodomain proteins and the membrane-associated guanylate kinase CASK/LIN-2 (Garg et al., 2003; Hiroi et al., 2001; Bruneau et al., 2001). CASK/LIN-2 can enter the nucleus and form a complex with the T-box protein Tbr-1 to induce the transcription of target genes (Hsueh et al., 2000). LIN-2 is the *C. elegans* homolog of CASK/LIN-2. Mutations in the gene encoding LIN-2 have no effect on embryonic viability, suggesting that LIN-2 is not an essential co-factor for TBX-37, TBX-38. The mouse T-box protein Tbx5 can bind the homeodomain protein Nkx2-5 and recognize adjacent binding sites within the promoter of a target gene. The *C. elegans* homolog of Nkx2-5, which is encoded by *ceh-22*, is expressed in pharyngeal muscles and the pharyngeal defects caused by a mutation in *ceh-22* can be rescued by a vertebrate *nkx2.5* gene (Okkema et al., 1997; Haun et al., 1998). However, CEH-22/Nkx2-5 expression occurs after, and is dependent on, PHA-4 expression (Mango, 1994; Okkema et al., 1994), suggesting that CEH-22 is not likely to interact with TBX-37, TBX-38.

### Specification of ABp by the first Notch interaction

The first Notch interaction has been thought to ‘induce’ the ABp fate; P<sub>2</sub> and the Notch ligand APX-1 are essential for

normal ABp development, and forcing P<sub>2</sub> into ectopic contact with ABa causes ABa descendants to inappropriately adopt ABp-like fates (Hutter and Schnabel, 1994; Mango et al., 1994a; Mello et al., 1994; Moskowitz et al., 1994). Our present study provides strong evidence that the first Notch interaction is permissive rather than instructive for ABp development. TBX-37, TBX-38 are not detectable in ABp descendants in wild-type embryos, and *tbx-37 tbx-38* mutant embryos appear to have normal ABp development. Thus, TBX-37, TBX-38 do not contribute to ABp development in wild-type embryogenesis. Preventing the first Notch interaction causes ABp descendants to express TBX-37, TBX-38 inappropriately and to adopt incorrect fates. However, preventing both the first Notch interaction and TBX-37, TBX-38 expression simultaneously allows apparently normal differentiation of ABp descendants. Together, these results indicate that the primary, if not sole, function of first Notch interaction is to repress TBX-37, TBX-38 expression in ABp descendants. Notch signal transduction is believed to activate, rather than to repress, the transcription of target genes. Therefore, we hypothesize that Notch signaling at the four-cell stage represses *tbx-37* and *tbx-38* transcription through at least one intermediate. The absence of this intermediate in the ABa blastomere could allow the subsequent, Notch-independent, expression of TBX-37, TBX-38 in all ABa descendants.

ABa and ABp are born as equivalent cells, and all the differences that arise between these cells are thought to result from Notch-mediated interactions. If ABp, in the combined absence of Notch interactions and TBX-37, TBX-38, can still develop like a wild-type ABp, we would predict that ABa should be transformed into an ABp-like cell under the same conditions. We have not tested this prediction directly by constructing a *glp-1 tbx-37 tbx-38* triple mutant strain; however, some of our lineage data from *tbx-37 tbx-38* embryos addresses this prediction. The ABa descendant called ABarp is not signaled by either MS or P<sub>2</sub> (see Fig. 1B), and in a *tbx-37 tbx-38* mutant ABarp and its descendants will not contain TBX-37, TBX-38. Therefore, ABarp in a *tbx-37 tbx-38* embryo would be predicted to develop like the corresponding wild-type ABp descendant, called ABprp. The ABarp descendants ABarpaa and ABarpap remain on the surface in wild-type embryos, but ingress into the body cavity in *tbx-37 tbx-38* mutant embryos. Interestingly, the corresponding ABprp descendants (ABprpaa and ABprpap) ingress into the body cavity in wild-type embryos (Sulston et al., 1983). The ABarp descendant ABarppaaa divides into equal sized daughters in wild-type embryos, but divides asymmetrically to generate a small, posterior daughter that undergoes programmed cell death in *tbx-37 tbx-38* embryos. In wild-type embryos, the corresponding ABprp descendant (ABprppaaa) divides asymmetrically to generate a posterior cell death (Sulston et al., 1983).

One ABarp descendant in the *tbx-37 tbx-38* mutant embryos, called ABarppp, clearly did not resemble the corresponding ABprp descendant (ABprppp), and instead appeared nearly wild type (Table 1). In wild-type development, ABarppp and its sister are unusual in that they are born from an anteroposterior cell division and yet have identical fates; these sisters form bilaterally symmetrical clones of cells on the left and right sides of the body. All of the other 15 examples of anterior/posterior cell divisions that occur at the same time in

embryogenesis generate sister cells with different cell fates (Sulston et al., 1983). Thus, it is possible that the fate of ABarppp is regulated by unknown, Notch-independent events that are important for bilateral symmetry.

In summary, our results provide insight into two of the four Notch-mediated interactions that occur in rapid succession in early embryogenesis, and that modify ABa and ABp descendants in distinct ways. We propose that the transcription factors TBX-37, TBX-38 can promote 'primary' cell fates independent of Notch. The first Notch-mediated interaction blocks expression of TBX-37, TBX-38 in ABp descendants, thus allowing those cells to adopt novel, 'secondary' fates. Next, TBX-37, TBX-38 are expressed in ABa descendants independently of Notch, but shortly after the second Notch interaction. ABa descendants that do not undergo the second Notch interaction assume primary fates, in part through the action of TBX-37, TBX-38. In the ABa descendants that undergo the second Notch-interaction, TBX-37, TBX-38 collaborate with unidentified Notch targets to promote tertiary fates and mesoderm development.

We thank Judith Kimble, Susan Mango and Joel Rothman for providing reagents; and Liz Wayner for expert assistance in antibody production. We are greatly indebted to Paul Muhrad for communicating physical mapping results on *tDf7* and *ctDf3* prior to publication and for advice on mapping deficiencies. Some of the nematode strains used in this study were provided by the Caenorhabditis Genetics Center, which is funded by the NIH National Center for Research Resources. R.C. is supported by a long term fellowship from the Human Frontier Science Program, J.N. is supported by a Postdoctoral Fellowship Grant from the American Cancer Society (grant # PF-02-007-01-DCC), A.N. is supported by a predoctoral fellowship from the Portuguese Foundation of Science and Technology and by the Gulbenkian PhD Programme in Biomedicine, and K.G., R.H. and J.R.P. are supported by the Howard Hughes Medical Institute.

## References

- Alder, M. N., Dames, S., Gaudet, J. and Mango, S. E. (2003). Gene silencing in *Caenorhabditis elegans* by transitive RNA interference. *RNA* **9**, 25-32.
- Austin, J. and Kimble, J. (1987). *glp-1* is required in the germ line for regulation of the decision between mitosis and meiosis in *C. elegans*. *Cell* **51**, 589-599.
- Artavanis-Tsakonas, S., Rand, M. D. and Lake, R. J. (1999). Notch signaling: Cell fate control and signal integration in development. *Science* **284**, 770-776.
- Bowerman, B., Eaton, B. A. and Priess, J. R. (1992). *skn-1*, a maternally expressed gene required to specify the fate of ventral blastomeres in the early *C. elegans* embryo. *Cell* **28**, 1061-1075.
- Bowerman, B., Draper, B. W., Mello, C. C. and Priess, J. R. (1993). The maternal gene *skn-1* encodes a protein that is distributed unequally in early *C. elegans* embryos. *Cell* **74**, 443-452.
- Brenner, S. (1974). The genetics of *Caenorhabditis elegans*. *Genetics* **77**, 71-94.
- Bruneau, B. G., Nemer, G., Schmitt, J. P., Charron, F., Robitaille, L., Caron, S., Conner, D. A., Gessler, M., Nemer, M., Seidman, C. E. and Seidman, J. G. (2001). A murine model of Holt-Oram syndrome defines roles of the T-box transcription factor Tbx5 in cardiogenesis and disease. *Cell* **106**, 709-721.
- Chapman, D. L. and Papaioannou, V. E. (1998). Three neural tubes in mouse embryos with mutations in the T-box gene Tbx6. *Nature* **391**, 695-697.
- Chisholm, A. D. and Hodgkin, J. (1989). The *mab-9* gene controls the fate of B, the major male-specific blast cell in the tail region of *Caenorhabditis elegans*. *Genes Dev.* **3**, 1413-1423.
- Christensen, S., Kodoyianni, V., Bosenberg, M., Freidman, L. and Kimble, J. (1996). *lag-1*, a gene required for *lin-12* and *glp-1* signaling in

- C. elegans* is homologous to human CBF1 and Drosophila Su(H). *Development* **122**, 1373-1383.
- Fitzgerald, K., Wilkinson, H. A. and Greenwald, I.** (1993). *glp-1* can substitute for *lin-12* in specifying cell fate decisions in *Caenorhabditis elegans*. *Development* **119**, 1019-1027.
- Fitzgerald, K. and Greenwald, I.** (1995). Interchangeability of *Caenorhabditis elegans* DSL proteins and intrinsic signalling activity of their extracellular domains in vivo. *Development* **121**, 4275-4282.
- Gao, D. L. and Kimble, J.** (1995). APX-1 can substitute for its homolog LAG-2 to direct cell interactions throughout *Caenorhabditis elegans* development. *Proc. Natl. Acad. Sci. USA* **92**, 9839-9842.
- Garg, V., Kathiriyai, I. S., Barnes, R., Schluterman, M. K., King, I. N., Butler, C. A., Rothrock, C. R., Eapen, R. S., Hirayama-Yamada, K., Joo, K., Matsuoka, M., Cohen, J. C. and Srivastava, D.** (2003). GATA4 mutations cause human congenital heart defects and reveal an interaction with TBX5. *Nature* **424**, 443-447.
- Greenwald, I., Sternberg, P. W. and Horvitz, H. R.** (1983). The *lin-12* locus specifies cell fates in *Caenorhabditis elegans*. *Cell* **34**, 435-444.
- Hartenstein, V. and Posakony, J. W.** (1990). A dual function of the Notch gene in *Drosophila* sensillum development. *Dev. Biol.* **142**, 13-30.
- Haun, C., Alexander, J., Stainier, D. Y. and Okkema, P. G.** (1998). Rescue of *Caenorhabditis elegans* pharyngeal development by a vertebrate heart specification gene. *Proc. Natl. Acad. Sci. USA* **95**, 5072-5075.
- Hermann, G. J., Leung, B. and Priess, J. R.** (2000). Left-right asymmetry in *C. elegans* intestine organogenesis involves a LIN-12/Notch signaling pathway. *Development* **127**, 3429-3440.
- Hiroi, Y., Sudoh, S., Monzen, K., Ikeda, Y., Yazaki, Y., Nagai, R. and Komuro, I.** (2001). Tbx5 associates with Nkx2-5 and synergistically promotes cardiomyocyte differentiation. *Nat. Genet.* **28**, 276-280.
- Hobert, O.** (2002). PCR Fusion-based approach to create reporter gene constructs for expression analysis in transgenic *C. elegans*. *BioTechniques* **32**, 728-730.
- Horner, M. A., Quintin, S., Domeier, M. E., Kimble, J., Labouesse, M. and Mango, S.** (1998). *pha-4*, an HNF-3 homolog, specifies pharyngeal organ identity in *Caenorhabditis elegans*. *Genes Dev.* **12**, 1947-1952.
- Hsueh, Y. P., Wang, T. F., Yang, F. C. and Sheng, M.** (2002). Nuclear translocation and transcription regulation by the membrane-associated guanylate kinase CASK/LIN-2. *Nature* **404**, 298-302.
- Hutter, H. and Schnabel, R.** (1994). *glp-1* and inductions establishing embryonic axes in *C. elegans*. *Development* **120**, 2051-2064.
- Hutter, H. and Schnabel, R.** (1995). Establishment of left-right asymmetry in the *Caenorhabditis elegans* embryo is a multistep process involving a series of inductive events. *Development* **121**, 3417-3424.
- Iso, T., Hamamori, Y. and Kedes, L.** (2003). Notch signaling in vascular development. *Arterioscler. Thromb. Vasc. Biol.* **23**, 543-553.
- Kalb, J. M., Lau, K. K., Goszczynski, B., Fukushige, T., Moons, D., Okkema, P. and McGhee, J. D.** (1998). *pha-4* is Ce-fkh-1, a forkhead/HNF-3 alpha, beta, gamma homolog that functions in organogenesis of the *C. elegans* pharynx. *Development* **125**, 2171-2180.
- Kaletta, T., Schnabel, H. and Schnabel, R.** (1997). Binary specification of the embryonic lineage in *Caenorhabditis elegans*. *Nature* **390**, 294-298.
- Kostas, S. A. and Fire, A.** (2002). The T-box factor MLS-1 acts as a molecular switch during specification of nonstriated muscle in *C. elegans*. *Genes Dev.* **16**, 257-269.
- Lambie, E. J. and Kimble, J.** (1991). Two homologous regulatory genes, *lin-12* and *glp-1*, have overlapping functions. *Development* **112**, 231-239.
- Lin, R., Thompson, S. and Priess, J. R.** (1995). *pop-1* encodes an HMG box protein required for the specification of a mesoderm precursor in the early *C. elegans* embryo. *Cell* **83**, 599-609.
- Lin, R., Hill, R. J. and Priess, J. R.** (1998). POP-1 and anterior-posterior fate decisions in *C. elegans* embryos. *Cell* **92**, 229-239.
- Mango, S. E., Thorpe, C. J., Martin, P. R., Chamberlain, S. H. and Bowerman, B.** (1994a). Two maternal genes, *apx-1* and *pie-1*, are required to distinguish the fates of equivalent blastomeres in the early *Caenorhabditis elegans* embryo. *Development* **120**, 2305-2315.
- Mango, S., Lambie, E. J. and Kimble, J.** (1994b). The *pha-4* gene is required to generate the pharyngeal primordium of *Caenorhabditis elegans*. *Development* **120**, 3019-3031.
- Mello, C. C., Draper, B. W. and Priess, J. R.** (1994). The maternal genes *apx-1* and *glp-1* and establishment of dorsal-ventral polarity in the early *C. elegans* embryo. *Cell* **77**, 95-106.
- Moskowitz, I. P. G., Gendreau, S. B. and Rothman, J. H.** (1994). Combinatorial specification of blastomere identity by *glp-1*-dependent cellular interactions in the nematode *Caenorhabditis elegans*. *Development* **120**, 3325-3338.
- Moskowitz, I. P. G. and Rothman, A.** (1996). *lin-12* and *glp-1* are required zygotically for early embryonic cellular interactions and are regulated by maternal GLP-1 signaling in *Caenorhabditis elegans*. *Development* **122**, 4105-4117.
- Muhrad, P. J. and Ward, S.** (2002). Spermiogenesis initiation in *Caenorhabditis elegans* involves a casein kinase I encoded by the *spe-6* gene. *Genetics* **161**, 143-155.
- Okkema, P. G., Ha, E., Haun, C., Chen, W. and Fire, A.** (1997). The *Caenorhabditis elegans* NK-2 homeobox gene *ceh-22* activates pharyngeal muscle gene expression in combination with *pha-1* and is required for normal pharyngeal development. *Development* **124**, 3965-3973.
- Newman, A., White, J. G. and Sternberg, P. W.** (1995). The *C. elegans lin-12* gene mediates induction of ventral uterine specialization by the anchor cell. *Development* **121**, 263-271.
- Page, B. D., Zhang, W., Steward, K., Blumenthal, T. and Priess, J. R.** (1997). ELT-1, a GATA-like transcription factor is required for epidermal cell fates in *Caenorhabditis elegans* embryos. *Genes Dev.* **11**, 1651-1661.
- Papaioannou, V. E. and Silver, L. M.** (1998). The T-box gene family. *BioEssays* **20**, 9-19.
- Parks, A. and Muskavitch, M. A. T.** (1993). Delta function is required for bristle organ determination and morphogenesis in *Drosophila*. *Dev. Biol.* **157**, 484-496.
- Park, F. D. and Priess, J. R.** (2003). Establishment of POP-1 asymmetry in early *C. elegans* embryos. *Development* **130**, 3547-3556.
- Priess, J. R., Schnabel, H. and Schnabel, R.** (1987). The *glp-1* locus and cellular interactions in early *C. elegans* embryos. *Cell* **51**, 601-611.
- Ruvkun, G. and Hobert, O.** (1998). The taxonomy of developmental control in *Caenorhabditis elegans*. *Science* **282**, 2033-2041.
- Shelton, C. A. and Bowerman, B.** (1996). Time-dependent responses to *glp-1*-mediated inductions in early *C. elegans* embryos. *Development* **122**, 2043-2050.
- Schnabel, R. and Priess, J. R.** (1997). Specification of cell fates in the early embryo. In: *C. elegans* II, pp. 361-383. Cold Spring Harbor, NY: Cold Spring Harbor Laboratory Press.
- Sulston, J. E., Schierenberg, E., White, J. G. and Thomson, J. N.** (1983). The embryonic cell lineage of the nematode *Caenorhabditis elegans*. *Dev. Biol.* **100**, 64-119.
- Wayner, E. A. and Carter, W. G.** (1987). Identification of multiple cell adhesion receptors for collagen and fibronectin in human fibrosarcoma cells possessing unique alpha and common beta subunits. *J. Cell Biol.* **105**, 1873-1884.
- White, P. H., Farkas, D. R., McFadden, E. E. and Chapman, D. L.** (2003). Defective somite patterning in mouse embryos with reduced levels of Tbx6. *Development* **130**, 1681-1690.
- Woollard, A. and Hodgkin, J.** (2000). The *Caenorhabditis elegans* fate-determining gene *mab-9* encodes a T-box protein required to pattern the posterior hindgut. *Genes Dev.* **14**, 596-603.