

## REVIEW

# Using synthetic biology to explore principles of development

Jamie Davies\*

## ABSTRACT

Developmental biology is mainly analytical: researchers study embryos, suggest hypotheses and test them through experimental perturbation. From the results of many experiments, the community distils the principles thought to underlie embryogenesis. Verifying these principles, however, is a challenge. One promising approach is to use synthetic biology techniques to engineer simple genetic or cellular systems that follow these principles and to see whether they perform as expected. As I review here, this approach has already been used to test ideas of patterning, differentiation and morphogenesis. It is also being applied to evo-devo studies to explore alternative mechanisms of development and ‘roads not taken’ by natural evolution.

**KEY WORDS:** Differentiation, Morphogenesis, Pattern formation, Synthetic biology, Synthetic morphology, Validation

## Introduction

For most of its history, developmental biology has been mainly an analytical science with a strong focus on uncovering detailed mechanisms of embryogenesis. Early work was purely descriptive but, particularly from the mid-19th century, descriptive embryology was supported by hypothetico-deductive approaches in which researchers proposed hypotheses and tested them by manipulating embryos. Experimental techniques have included: surgery, resulting in the discoveries of regulative development and induction (see Glossary, Box 1); genetics, resulting in the correlation of genotype and phenotype and the implication of specific molecules in particular events; environmental perturbation, resulting in an understanding of the influences of external signals; and the production of chimaeras and mosaics (see Glossary, Box 1), resulting in an understanding of cell fates and potencies. The details of embryonic development have turned out to be complicated, particularly at the molecular level, and this has encouraged researchers to integrate results and formulate abstract principles through which embryonic development is thought to occur. These principles are expressed in terms much simpler than the fine details of any real embryonic event. Examples include the use of gradients to specify positional information [e.g. the French Flag Model (Wolpert, 1969), see Glossary, Box 1], the use of reaction-diffusion (see Glossary, Box 1) for *de novo* patterning (Turing, 1952), the use of feedback by trophic signals to balance cell populations (Raff, 1992), and the use of a landscape of creodes (see Glossary, Box 1)

and Boolean networks (see Glossary, Box 1) to determine transitions between states (Waddington, 1957; Kauffman, 1993). There are, of course, many more. These principles stand above the level of the specific details of any particular developmental system, analogous to the way that the principles of rhythm and harmony stand above the specific details of any particular symphony. Together, the principles form a framework for our current understanding of development, even though, as in the musical analogy, it may be that real embryos demonstrate the pure principles only approximately, each being cluttered with different detailed variations.

However, in any field limited to analysis, the verification of derived principles is problematic. Confirming the details of a particular developmental event – for example, that gene X is necessary for process Y – is straightforward, but proving that the conceptual principles are fully adequate is more of a problem. The field of synthetic biology can help to overcome this problem: if a complex system is believed to achieve its action according to a simple principle, then constructing a new system based on that principle and assessing whether it performs the required action provides a powerful verification. This idea that biological understanding is best understood by using it to construct artificial systems is by no means new: in 1912, the pioneering synthetic biologist Stéphane Leduc stated ‘when a phenomenon has been observed in a living organism, and one believes that one understands it...one should be able to reproduce this phenomenon on its own’ (Leduc, 1912). Many years later, Richard Feynman made a similar point, in the context of mathematical equations, writing ‘What I cannot build, I do not understand’. Leduc was most interested in the biophysics of morphogenesis, and the main focus of his book *La Biologie Synthétique* (Leduc, 1912) was the construction of non-living analogues of biological forms. This work, which drew on the work of earlier synthetic biologists such as Traube (Traube, 1866) and which in turn gave strong inspiration to the pioneer of theoretical embryology, Thompson (Thompson, 1917), was itself a scientific dead-end, because the similarities of shape between organisms and inorganic forms turned out to be mainly coincidental and not due to common morphogenetic mechanisms. For this reason, synthetic biology largely disappeared after the First World War.

The 21st century has seen a dramatic resurgence of synthetic biology, now with a focus on the construction of designed genetic systems. Much of the work in this modern era of synthetic biology has been concerned with industrial applications, such as the construction of new metabolic pathways for production of drug precursors (Ro et al., 2006) or biofuels (d’Espaux et al., 2015), or the construction of systems to detect traces of pollution (Webster et al., 2014). There is also discussion, and some preliminary data, regarding the potential use of synthetic biology for tissue regeneration and regenerative medicine, both for creating better disease models and for constructing treatments (Ruder et al., 2011; Hutmacher et al., 2015; Davies and Cachat, 2016). The technology also lends itself, however, to being used as a tool for the basic

Centre for Integrative Physiology, University of Edinburgh, Hugh Robson Building, George Square, Edinburgh EH8 9XB, UK.

\*Author for correspondence (jamie.davies@ed.ac.uk)

 J.D., 0000-0001-6660-4032

This is an Open Access article distributed under the terms of the Creative Commons Attribution License (<http://creativecommons.org/licenses/by/3.0>), which permits unrestricted use, distribution and reproduction in any medium provided that the original work is properly attributed.

Received 29 August 2016; Accepted 14 February 2017

**Box 1. Glossary**

**Boolean network:** A network of entities (e.g. genes) that can be in one of two states, 0 or 1, and that are controlled by the states of other entities (genes) in the network, with controls from several genes on the same controlled gene being combined according to a Boolean rule. For example, 'Gene D will be in state 1 if genes A AND gene B are in state 1 OR if gene C is in state 1.' [see Kauffman (1993) for more details].

**Chimaera:** An embryo formed from a mix of cells from two embryos of different genotypes.

**Creode:** One of a range of possible trajectories in state space that might be pursued, in normal development, by an embryonic cell as it develops towards one of a choice of fates. Croedes are akin to branching railway tracks in a marshalling yard, down which wagons can be switched.

**French Flag Model:** An illustration of the principles by which morphogen gradients work: the idea is that a morphogen gradient extends across a blank flag and the cells therein read the levels of morphogen to decide whether to be red, white or blue.

**Hysteresis:** A response that follows one pathway in the forward direction but a different pathway in the return direction (e.g. a thermostat that turns 'on' at 20°C but 'off' at 22°C). Hysteresis can be used to avoid vacillation.

**Induction:** In developmental biology, triggering the development of one tissue using signals coming from a different tissue; in genetics and synthetic biology, triggering gene expression using an exogenous factor.

**Inverting path:** A signalling pathway in which activation at the start causes inhibition of the output.

**Lateral inhibition:** A cell following a fate choice makes a local signal that inhibits its neighbours from making the same choice. This is one mechanism for regulative development (q.v.).

**Morphogen:** A diffusible signalling molecule, the local concentration of which influences development.

**Mosaic:** An embryo or tissue formed from a mix of cells of different genotypes, usually made by mutation of one or more cells in a normal two-parented embryo.

**Orthogonality:** The (ideal of) non-interaction between two systems (e.g. synthetic and natural).

**Oscillators:** Devices (natural or engineered) that generate an output that rises and falls repeatedly.

**Phase-locking:** Keeping the oscillations of multiple devices or cells in step with one another.

**Quorum sensing:** Cells detecting the size of the aggregate in which they are located.

**Reaction-diffusion:** A mechanism for generating patterns in which the local concentration of signalling molecules depends on both the local reactions (synthesis and destruction) of the molecules and also their diffusion.

**Regulative development:** A mode of development in which feedback controls cell fate so that, for example, deletion of cells fated to make a specific structure is followed by their automatic replacement by neighbours not initially fated to make that structure.

**Segmentation:** In development, the division of the body into segments (e.g. those obvious even from the outside of an earthworm).

sciences. In particular, it can allow developmental biologists to construct 'developmental' systems based on the current principles in the field, and to verify that mechanisms that seem realistic in computer models are realistic in living cells. It can also allow the testing of new ideas derived from imagination rather than analysis of real embryos; these ideas might be alternative methods for performing a task that seems not to be used in naturally evolved organisms.

Although the application of synthetic biology to development is a young field, it is clear that progress has been made and that the field is expanding. Here, I review this progress with the aim of bringing together the results, engaging greater numbers of mainstream developmental biologists and, hopefully, stimulating interesting collaborative research. The processes of development are often

divided into patterning, differentiation and morphogenesis, and this Review is organized according to that structure, with the principles of each topic being described first, followed by presentation of the synthetic biological systems that have been built to better understand these principles. In each section, at least one seminal synthetic biological mechanism is explained in detail and, to save space, related systems are described only in sufficient depth to convey the developmental biological relevance of the later work: details can be found in the cited papers.

Before going into details, one thing should be made clear: I am not arguing that a synthetic biological approach will be the best way to discover the mechanistic details of any specific embryological event. The only way to do that is to study the event in the real embryo. Rather, I argue that synthetic biology allows us to test and further develop high-level principles of biological self-organization that underlie embryogenesis in general. Synthetic approaches have been used in this way in other sciences: it was experience with synthetic chemistry, rather than the analysis of natural compounds, that finally illuminated the nature of the chemical bond (reviewed by Asimov, 1979). Similarly, discoveries made when building and testing engineered electrical apparatus led to an understanding of electricity in general that could then be applied back to complicated natural phenomena such as electrophysiology (Piccolino, 1997). This article will make an argument that synthetic biological systems will be of similar use to developmental biology.

**Understanding the process of patterning**

At its most basic level, patterning can be defined as the process that leads to the features of an organism (gene expression, appendages, folds, hairs, etc.) being arranged in a manner that is statistically distinguishable from being random. Such patterns can be spatial or temporal, or both. Some instances of patterning create patterns *de novo* in homogenous fields of cells with no existing cues, as seen, for example, in the patterning of heterocysts (nitrogen-fixing cells) in cyanobacteria (reviewed by Zhang et al., 2006). Others add detail to existing patterns, e.g. the segmentation (see Glossary, Box 1) of a fruit fly larva that already has simple anteroposterior gradients: Akam, 1987). As I discuss below, a number of classical studies have identified principles that could underlie patterning, and more recent synthetic biology approaches have put these principles to the test.

**Principles of patterning**

Temporal patterns in developmental biology operate on many scales (reviewed by Uriu, 2016), from minutes (e.g. the somite clock, the output of which is transformed into a spatial pattern: reviewed by Oates et al., 2012), to hours (e.g. circadian rhythms, which control the development of many organisms including humans, reviewed by Zhao et al., 2014), and to months and years (e.g. reproductive cycles). Examination of repeating, oscillating patterns such as the somite clock and circadian rhythms shows them to operate using large numbers of components with a complex web of interactions (reviewed by Hurley et al., 2016; Yabe and Takada, 2016; Shimojo and Kageyama, 2016), but some clear principles emerge. The key one is that, at their cores, many oscillators (see Glossary, Box 1) use a combination of negative feedback mediated by mechanisms that have intrinsic delays (Lewis, 2003). The action of at least one molecule in the system is to trigger a series of events that result (after delays in transcription, protein synthesis, protein degradation, etc.) in its own inhibition: the essence of this basic principle can be reduced to the simple network shown in Fig. 1A (Lewis, 2003; Richmond and Oates, 2012). The length of the cycle is controlled by the intrinsic delays and the dose-response sensitivities of each stage.

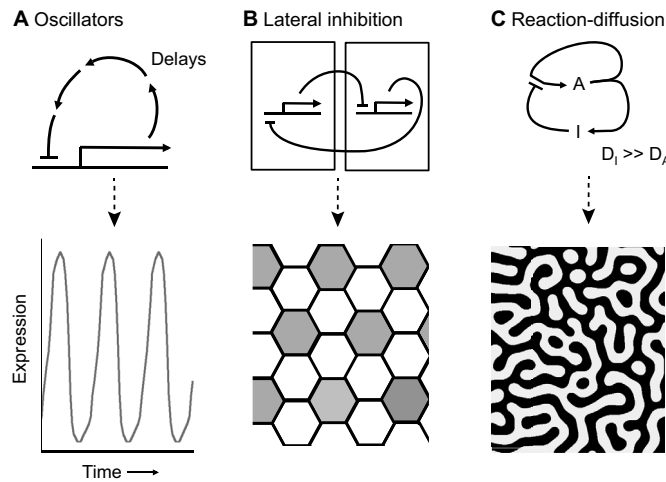

**Fig. 1. Principles of *de novo* pattern formation.** (A) The basic topology of biological oscillators, which can generate patterns in time, is depicted. A gene transcribed from a promoter acts, via time-consuming intermediate steps (represented by the series of arrows), to repress its own synthesis. Without delays, this would be a homeostat but with the delays it keeps ‘overshooting’ initial transcription and forming enough transcript to ensure deep repression once translation has had time to occur, so that no more is made. When the repressor has decayed, transcription begins again but there will be a delay before the protein is made again, and so on. (B) The action of a simple lateral inhibition system, in which expression of a gene in one cell can inhibit expression of the same gene in its neighbours, is depicted. This can result in a patchwork of cells that express the gene (grey) and those that do not (white): the patchwork is stable because the white cells express none of the gene product to turn expression in the grey cells off. (C) A simple reaction-diffusion system is shown, in which a poorly diffusible activator (A) activates its own production and that of a well-diffusing inhibitor (I). Where activator levels are high, its activity is enough to ensure activator production, even though there is inhibitor production too, because the inhibitor diffuses away so its level remains below that of the activator. In the zones near the activator, the levels of the inhibitor are high enough to ensure that no activation can take place there. This produces a spaced-out pattern of regions dominated by activation and by inhibition. The diffusion constant for the inhibitor,  $D_I$ , greatly exceeds that of the activator,  $D_A$ .

It is clear that the core principle shown in Fig. 1A – that oscillations can arise from delayed negative feedback – is much simpler than that underlying real examples, and misses out features that ensure robustness and phase-locking (see Glossary, Box 1) between adjacent cells. The crucial issue is whether a simple delayed-inhibition network principle is, in fact, adequate to drive biological oscillation in real biological cells.

The principles for *de novo* spatial pattern generation also tend to use negative feedback, sometimes in collaboration with positive feedback. In systems that use lateral inhibition (see Glossary, Box 1), such as the *Drosophila* neurogenic ectoderm (Campos-Ortega, 1995), stochastic fluctuations in a field of initially identical cells cause some cells to express more of a gene than their neighbours and these cells inhibit expression of that same gene in neighbours (Fig. 1B). Where the gene is connected to differentiation, a field of initially identical cells can be divided into different fates. Spatial patterns can also arise via the reaction-diffusion models of Turing, and Gierer and Meinhardt (Turing, 1952; Gierer and Meinhardt, 1972), which can generate multiple patterns during development. In this context, one molecule, an ‘activator’, combines positive feedback to activate its own synthesis with negative feedback, activating the synthesis of an inhibitor that inhibits the action of the activator (Fig. 1C). Turing systems are thought to underlie many different examples of developmental patterning, including mesodermal and left-right organization (Müller et al., 2012), mammalian palatal rugal ridge formation (Economou et al., 2012), hair follicle spacing (Sick et al., 2006), finger formation (Raspopovic et al., 2014) and nano-features of insect cornea (Blagodatskia et al., 2015).

One important principle of patterning that was proposed almost 80 years ago is that cell behaviour can be determined by local concentrations of a morphogen (see Glossary, Box 1) that is present across a tissue in a concentration gradient (Dalcq, 1938; Wolpert,

1969). In this case, one or more concentration gradients of diffusible morphogens emanating from cells in a specific differentiated state permeates a field of initially identical cells, and will form a gradient if the half-life of the molecule is short enough for the whole field not to fill up with it (Crick, 1970; Ashe and Briscoe, 2006). The activation of different genes at different thresholds of morphogen was initially thought to result from different genes having different sensitivities to the inducing power of the morphogen, and early analysis of some simple systems supported this view (Driever et al., 1989). It became clear, however, that this was not a universal mechanism: detailed analyses showed that gene expression along a gradient is not simply additive, with genes induced by moderate levels of morphogen still being active at high levels, but instead is more complex so that genes induced by moderate levels of morphogen are off again at higher levels. More recent attention has shifted from the idea that gene activation responses are determined by the individual genes themselves to the idea that they are determined by regulatory networks (Briscoe and Ericson, 2001). A combination of experimental and theoretical studies has identified a few specific three-gene network feed-forward topologies as being particularly likely to underlie the translation of continuous morphogen gradients into discrete cell states (Cotterell and Sharpe, 2010). One of these networks, called the ‘classical’ network by Cotterell and Sharpe because it is derived from classical studies of the famous *Drosophila* anteroposterior patterning system, is shown in Fig. 2A, whereas another broadly similar design, the three-gene incoherent feed-forward (3GIFF) network, is shown in Fig. 2B. In these networks, a signal passes from the input gene to the output gene by two separate paths, one of which inverts the signal and the other of which passes the signal on in its original sense. Different sensitivities in the paths allow expression of the output gene only at intermediate levels of the input signal; different kinetics affect how rapidly patterns (stripes in this

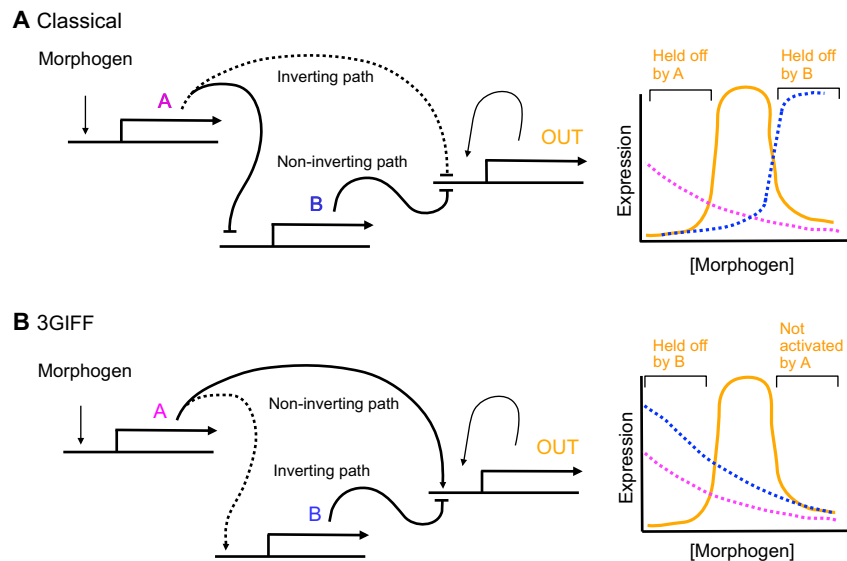

**Fig. 2. The interpretation of morphogen gradients in embryos.** (A) In the classical network, a transcriptional inhibitor A is produced in proportion to the local morphogen concentration. A can inhibit transcription of the output gene and also transcription of a second transcriptional inhibitor, B, that in turn can inhibit the network's output gene (OUT). The promoters for B and the output gene are 'on' unless inhibited. At low concentrations of morphogen, there is too little A produced to prevent production of B, so B inhibits transcription of the output gene. At intermediate levels, there is sufficient A to inhibit production of B but, because of a weaker interaction between A and the promoter of the output gene (symbolized by the dotted line), these concentrations of A are not sufficient to inhibit transcription of the output gene. At higher levels, A directly inhibits the output gene. (B) In the three-gene incoherent forward-feedback (3GIF) network, A is again produced in proportion to the morphogen and activates transcription of the output gene and of the inhibitor B. At low levels of morphogen, there is insufficient A to drive expression of the output gene. At intermediate levels, there is sufficient A to drive output gene expression but not significant expression of B. At high levels, enough B is produced to inhibit output gene expression. In both networks, optional positive feedback of the output gene on itself makes boundaries sharper.

case) are established. It should also be noted that responses to real gradients depend both on concentration and on time (Yang et al., 1997; Ashe and Briscoe, 2006; Kutejova et al., 2009) and can be ratchet-like, such that rising concentrations of morphogen can drive a more up-gradient type response but falling concentrations do not pull cells already exposed to high concentrations towards low-concentration type responses (Gurdon et al., 1995). Signals in the concentration and time domains can also be inter-converted: chick neural cells, for example, can convert concentrations of the morphogen Sonic hedgehog (SHH) into durations of signal pathway activation (Dessaud et al., 2007). There is also a growing appreciation that gradients usually set up fairly crude patterns that are later improved by cell-cell signalling and regulatory networks (reviewed by Briscoe and Small, 2015).

#### Demonstrating the principles of patterning using synthetic biology

The construction of temporal oscillations in cells by negative feedback with time delays (Elowitz and Leibler, 2000) was the first example of synthetic biology being used to test a developmental principle – in this case that oscillation can arise from delayed negative feedback – by using it as the basis for design. Working in *E. coli*, Elowitz and Leibler built a triangular network of three inhibitory transcription factors,  $\lambda$ cl (cI transcriptional repressor from bacteriophage  $\lambda$ ), LacI (repressor of *E. coli* lactose-metabolizing operon) and TetR (tetracycline-dependent transcription repressor) (Fig. 3A). Each was expressed from a promoter that would be constitutively 'on' but contained an operator site for one of the other proteins, which could hold transcription off.  $\lambda$ cl inhibited transcription of LacI, LacI inhibited transcription of TetR, and TetR inhibited the transcription of  $\lambda$ cl: in other words, the indirect action of each gene was to inhibit the expression of itself. In the absence of any transcriptional and translational delays, the system would tend

towards stable low expression but the presence of delays promoted oscillation. The action of the network can be understood by imagining starting with any one of the genes 'on', e.g.  $\lambda$ cl. This will inhibit LacI transcription and, once the remaining LacI protein has decayed, the LacI operator site in the TetR protein will be unoccupied and TetR will be transcribed and translated, and its protein will shut down  $\lambda$ cl transcription. When  $\lambda$ cl protein has decayed, LacI transcription and translation will begin, and TetR expression will be shut down. Once TetR protein has decayed,  $\lambda$ cl expression will begin and the system will be back where we started (Fig. 3B). Thus, the system will show alternative phases of  $\lambda$ cl, TetR and LacI expression. The decay of each protein was accelerated by

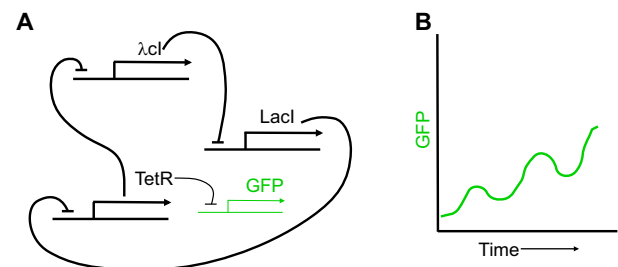

**Fig. 3. A synthetic temporal pattern generator.** (A) The topology of the temporal pattern generator constructed by Elowitz and Leibler (2000) is shown. The network consists of three genes, each one of which represses the transcription of the next one along in the network. Each gene is transcribed unless repressed. Starting, for example, when transcription of cI becomes active, its protein, when translated, will repress LacI production, so once any remaining LacI has decayed, TetR can be transcribed and will repress cI again. Repression of cI will, once cI protein has decayed, allow LacI to be transcribed, thereby shutting off TetR and, once TetR has decayed, allowing cI on again, and so on. (B) This behaviour gives rise to oscillations of GFP.

engineering the protein to be a target for the degradative machinery of the host. In practice, a GFP (green fluorescent protein) reporter of TetR activity, also engineered for rapid degradation, showed oscillations in many cells and these could be stopped by a sugar analogue that blocked LacI action. This simple system, built according to the basic principle of negative feedback with delay, had several limitations: only about 40% of the cells showed oscillations, the oscillation in each cell was variable in both amplitude and frequency, and the oscillation of different cells was not synchronized. It therefore both verified the basic principle of and emphasized its limitations, thereby highlighting that real biological systems probably exhibit more complexity.

More recent work has addressed some of these limitations by improving the system in various ways (e.g. Stricker et al., 2008; Hussain et al., 2014; Niederholtmeyer et al., 2015). Some of these have been particularly useful in highlighting features that can make great differences to the precision of systems, some of which might be counter-intuitive. An example identified by Potvin-Trottier et al. (2016) and reviewed by Gao and Elowitz (2016) is the noise inherent in very high-affinity transcriptional repressor systems. The TetR protein has a high affinity for its operator site and, as cellular concentrations of TetR fall, re-expression of genes from operator sites happens when the concentration of TetR protein has dropped to about five protein molecules per cell. The timing of reactivation in such a system is therefore not predictable by equations that describe decay averaged over thousands of molecules, but is instead exquisitely sensitive to the stochastic loss of only a handful of individual proteins, producing variability from cycle to cycle and from cell to cell. This problem could be ameliorated by adding into the cells some extra TetR-binding sites, not connected with any gene but just to provide a buffer, raising the threshold number of proteins per cell at which the change from repression to permission took place. The effectiveness of this raises interesting questions about the purpose of apparently non-functional binding sites for transcriptional regulators in the genome (MacQuarrie et al., 2011). A second example identified in the same report was a problematic interaction between two features of the original design: the placing of the GFP reporter on a plasmid separate from the rest of the system, and the engineering all of proteins, including the reporter, to ensure that they are destroyed by a natural protein-degrading system in the cell. Variations in the copy number of the GFP reporter created variations in the amplitude of the response, as might be expected, but there was a second effect that, with GFP competing with the transcriptional repressors for the protein-degrading machinery, variations in reporter plasmid copy number could alter the half-life of the transcriptional repressors and therefore alter the period of oscillation. Integrating the reporter into the main plasmid or eliminating the active degradation signals both improved precision. Combining this with the buffering TetR-binding sites reduced the standard deviation of period (from 35% of the mean to 14% of the mean). It might be argued that the issues of reporter plasmid copy number and engineered degradation signals are much more relevant to the practice of synthetic biology than to understanding normal development but, by highlighting the destabilizing effects of relying on limited-capacity cellular systems for ‘housekeeping’ tasks such as protein degradation, they do provide more context for understanding why natural robust circuits might be arranged as they are.

Simple negative-feedback loop oscillators have also been constructed in mammalian cells. An example is provided by Swinburne et al. (2008), who constructed a protein consisting of the TetR transcriptional repressor, tagged for rapid destruction and

equipped with a nuclear localization signal and a fluorescent domain. This was placed downstream of a constitutive promoter with a Tet (tetracycline) operator site. An interesting feature was that the transcription start site and the open reading frame of the protein were separated by an intron, produced in versions of varying length. The fluorescence oscillated, with considerable variation between cells apparently because translation occurred in bursts rather than steadily, and the period of the oscillation increased with intron length. This raises the interesting possibility that one function of introns may be to determine the timing of protein production following the initiation of transcription, whether in oscillators or other systems, as had been suggested on theoretical grounds (Monk, 2003).

The above approaches examined how oscillations can arise in individual cells, but how can such oscillations be synchronized between adjacent cells? This problem has been tackled by Danino et al. (2010), who made use of genes involved in acyl homoserine lactone (AHL)-based quorum sensing (see Glossary, Box 1) in *Vibrio* and *Bacillus* to produce another oscillator based on delayed negative feedback. Their system used promoters dependent on the AHL-activated transcription factor LuxR (AHL-activatable activator of the luminescence operon of *V. fischeri*) to drive production of the AHL-synthesizing enzyme, an AHL-degrading enzyme and a reporter gene. AHL diffuses freely between cells, so the phase of AHL fluctuations between neighbouring cells cultured in modest flow (to prevent AHL accumulating too much) eventually became synchronized. The oscillation was remarkably steady, illustrating the advantage of using a phase-locked population to average out stochastic variations between individual cells. This observation gives a new perspective on natural oscillators such as the somite clock. Is the running of this clock by a population of cells rather than by one single ‘pacemaker’ cell an adaptation to ensure steadier time-keeping? What happens, for example, if the population is reduced? Is there any correlation between steadiness of time-keeping and cell population size if many different natural clock systems are studied?

Synthetic biology approaches have also been used to test proposed mechanisms of spatial patterning. Although no synthetic reaction/diffusion-based models of *de novo* spatial patterning seem to have been built to date, the spontaneous patterning of mammalian cells has been achieved using a system based on adhesion-mediated phase separation (Cachat et al., 2016; see the penultimate section of this Review for details). In addition, several systems that generate patterns, not *de novo* but from existing cues placed into the system by an experimenter, have been built. Two striking examples tested the idea of translating morphogen concentration into distinct patterns of gene expression using synthetic versions of the ‘classical’ and ‘3GIFF’ network topologies described earlier. The first to be made was an *E. coli*-based network (Fig. 4A) with a topology similar to that of the ‘classical’ network shown in Fig. 2A (Basu et al., 2005). The slight increase in complexity comes from the use of the transcriptional activator, LuxR, to interface the molecule to be used as a ‘morphogen’, AHL, with the network (Fig. 4A). The inverting path (see Glossary, Box 1) was given its necessary lower sensitivity by the use of a mutant transcriptional repressor, LacI<sub>M1</sub> (a reduced-activity mutant of LacI), which has a lower activity than wild-type LacI in the non-inverting path. To create the gradient, a second population of *E. coli* was engineered to produce AHL, and a small colony of these was used as a source. When cells experienced very little or no AHL, LuxR was inactive and did not drive significant production of LacI<sub>M1</sub> or  $\lambda$ cI: with no  $\lambda$ cI, LacI was produced, and it bound to the operator site in the GFP

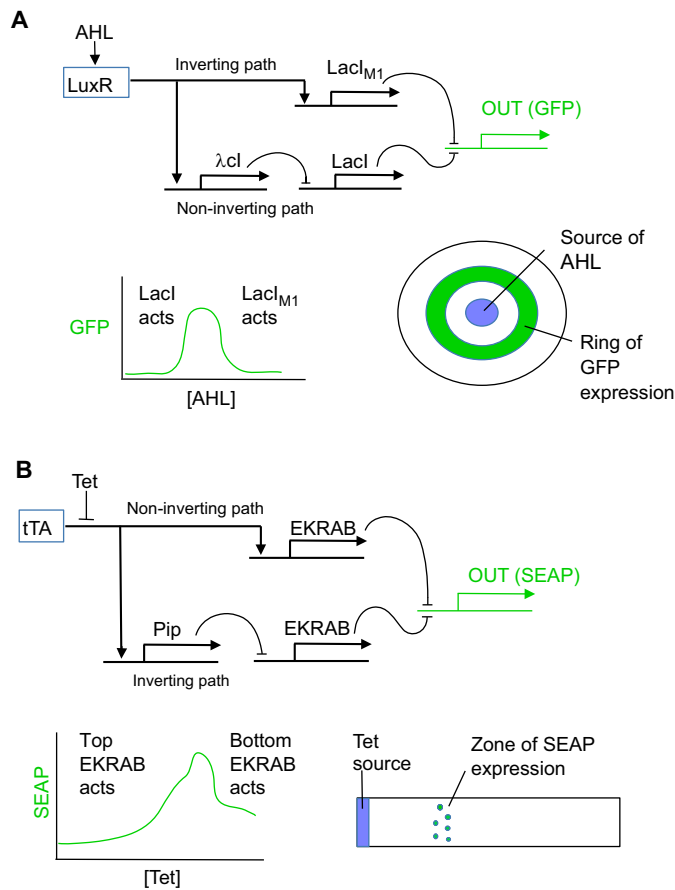

**Fig. 4. Interpreting positional information in a morphogen gradient.** Two realizations of networks for translating morphogen concentration into distinct patterns of gene expression are shown. (A) This network is based on the ‘classical’ network and confers on bacteria an ability to respond to positional information in a gradient of acyl homoserine lactone (AHL). *LacI* (repressor of *E. coli* lactose-metabolizing operon) is a strong repressor, but *LacI<sub>M1</sub>* (a reduced-activity mutant of *LacI*) is weak. At very low concentrations of AHL, there is not enough AHL to produce  $\lambda cl$  (*cl* transcriptional repressor from bacteriophage  $\lambda$ ) and *LacI* is therefore transcribed and holds GFP ‘off’. In medium AHL concentrations,  $\lambda cl$  represses *LacI* but the amount of *LacI<sub>M1</sub>* is too low to repress GFP, and GFP is therefore produced. At high concentrations, there is enough *LacI<sub>M1</sub>* to repress GFP. As a result, bacteria growing around a single AHL source produce a green ring. (B) This network is based on the three-gene incoherent feed-forward (3GIFF) network and confers on mammalian cells the ability to respond to positional information in a gradient of tetracycline (Tet). Tet inhibits rather than activates the two transcription factors [EKRAB (*E. coli* macrolide resistance operon repressor E fused to the human trans-silencing domain KRAB) and Pip (pristinamycin-induced protein)] immediately downstream of the tetracycline-binding transactivator (tTA). At low Tet concentrations, tTA is active enough to drive EKRAB production along the top path and shut off expression of the output gene (SEAP). At intermediate concentrations, tTA activity is too low to maintain output inhibition via the top path but can induce sufficient Pip to repress EKRAB on the bottom path; the output gene is therefore not inhibited by either path. At higher Tet concentrations, tTA is too weak to maintain Pip expression, and EKRAB in the bottom path is thus transcribed and inhibits output gene expression. The result is the production of the output gene only in a defined zone of a concentration gradient.

promoter to shut off GFP transcription. When cells experienced moderate concentrations of AHL, LuxR was moderately active and  $\lambda cl$  was transcribed, blocking the production of *LacI*. *LacI<sub>M1</sub>* was also transcribed but, being a weak inhibitor, it was at concentrations insufficient to inhibit GFP. GFP was therefore transcribed and the cells fluoresced. At higher concentrations of AHL, LuxR was more

completely activated and the concentration of the weak inhibitor *LacI<sub>M1</sub>* rose sufficiently to shut down the production of GFP. Bacteria growing around a single AHL source therefore produced a green ring (Fig. 4A), proving that the classical topology identified by Cotterell and Sharpe is indeed capable of activating gene expression in a specific concentration band of a morphogen gradient in real cells.

In the second example (Fig. 4B), Greber and Fussenegger (2010) used mammalian cells as hosts for a synthetic patterning system based on the 3GIFF topology. Again, the ‘morphogen’ (tetracycline, Tet) inhibited rather than activated the two transcription factors [EKRAB (*E. coli* macrolide resistance operon repressor E fused to the human trans-silencing domain KRAB) and Pip (pristinamycin-induced protein)] immediately downstream of the tetracycline-binding transactivator (tTA) in the network, reversing the sense of the signal: again, the normal sense of each arm of the pathway was ensured by including an additional inverting stage in each. The short top path of the network was, therefore, like the network in Fig. 2B (i.e. non-inverting), whereas the long bottom path was inverting with respect to the original Tet signal. The bottom path was also more sensitive. At low concentrations of Tet, tTA was active enough to drive EKRAB production along the top path and shut off expression of the output gene (SEAP, secreted embryonic alkaline phosphatase). At intermediate concentrations of Tet, tTA activity was too low to maintain output inhibition via the top path but was adequate to induce sufficient Pip to repress the EKRAB on the bottom path; the output gene was therefore not inhibited by either path. At higher concentrations of Tet, tTA was too weakly expressed to maintain Pip expression and the EKRAB of the bottom path was thus transcribed and inhibited output gene expression. The result was still the production of the output gene only in a defined zone of a concentration gradient, showing that the 3GEFF topology is indeed adequate for interpretation of a morphogen gradient.

It is important to note that neither system sets out to replicate the details of any part of an embryo: rather, the systems were designed from basic principles using components from several different organisms. Their importance is that they demonstrated that this architecture of signalling really can be used to interpret a gradient. More sophisticated versions of these circuits have now been made, allowing the concentration response to be ‘tuned’ externally with additional signals (Sohka et al., 2009).

**The process of differentiation**

Differentiation is connected intimately with the expression of different sets of genes, but it is not simply a matter of activating new gene expression. Indeed, cells need to switch genes on and off in order to differentiate, but they can also respond to external signals via changes in gene expression without changing their differentiated state. Differentiation has been studied multiple contexts, both *in vivo* and *in vitro*, and these various studies have provided insights into the general principles that govern cell differentiation. As I discuss below, some of these key principles have been tested in synthetic systems.

**Principles of differentiation**

Differentiation has two features that go beyond mere gene control. The first is that transitions between states tend to be made in an all-or-none manner; cells do not usually vacillate between being one cell type and another, even in the face of noisy signal inputs (discussed by Huang et al., 2007). In other words, the trigger may be analogue and varying, but the response is digital. The second feature

is that differentiated states, once reached, tend to be stable and independent of the signal that promoted differentiation: it is for this reason that differentiated cells can be placed into cell culture. Examination of the signalling events that trigger differentiation has suggested an important principle by which cells make clear irreversible decisions in the face of noisy inputs: the use of positive feedback to produce hysteresis (see Glossary, Box 1; Fig. 5A), in which a new cell state can be maintained with a lower level of initiating signal than is required to enter it (Angeli et al., 2004). An example is seen in the commitment of *Xenopus* oocytes to maturation in response to progesterone, which signals via a MAPK (mitogen-activated protein kinase) signal transduction cascade. In these cells, the synthesis of Mos (Moloney murine sarcoma viral oncogene homolog), an element of the signal transduction chain, is increased by MAPK that lies downstream of Mos (Ferrell and Machleder, 1998; Xiong and Ferrell, 2003). Activation of the pathway therefore makes it more sensitive, latching it and making its activation robust to fluctuations in the driving signals.

Positive feedback can also play a role in self-maintenance of a differentiated state. This was first understood from studies of simple systems such as bacteriophage lambda, in which the lysogenic ‘state of differentiation’ involves expression of a transcription factor,  $\lambda$ CI, that activates its own transcription while inhibiting the transcription of genes characteristic of the lytic state (Johnson et al., 1981). More complex biological systems have been more difficult to analyse as there are more components involved, but computer simulations of

large random Boolean networks of genes indicate that the existence of stable, self-maintaining ‘differentiation’ states is a natural property of such networks, and that the states are held stable by positive feedback (Kauffman, 1993).

#### Understanding differentiation using synthetic biology

The principle of using positive feedback and hysteresis to achieve robust, non-oscillating responses to noisy inductive stimuli has been tested in a synthetic mammalian genetic network (Kramer and Fussenegger, 2005). This network (Fig. 5B) was designed to achieve hysteresis in the same way that natural pathways are thought to – by positive feedback from a lower point in a pathway to higher point (Fig. 5A). Presumably because engineering new DNA elements is currently easier than engineering new elements of protein-based signal transduction cascades, the mechanism was realized as a path from small molecule, to transcription factor, to promoter, to bicistronic effector transcript, with one product of the effector transcript feeding back positively on the activity of the promoter (Fig. 5B).

The principle of using positive feedback to create truly self-sustaining patterns of gene expression in response to transitory signals has also been realized in synthetic systems using small numbers of genes. One example was constructed by Kramer et al. (2004) and is based on two genes, each of which encodes a transcriptional inhibitor that targets the promoter of the other gene (Fig. 6). Each transcriptional inhibitor can be inhibited by a soluble ‘signal’ (an antibiotic). Consider the network in the condition in which EKRAB is being expressed: it will inhibit transcription of PIPKRAB (*E. coli* pristinamycin resistance operon repressor E fused to the human trans-silencing domain KRAB) and the network state is stable. The temporary presence of erythromycin blocks the ability of EKRAB to inhibit transcription of PIPKRAB, so PIPKRAB is transcribed and shuts down EKRAB production. With no EKRAB being produced there is no longer any requirement for erythromycin to allow PIPKRAB production. The network therefore enters its alternative stable state. Obviously gene networks in real differentiating cells involve far more than only two genes, but the network at least shows that the principle of self-sustaining networks based on transcription factors can work in real cells.

More recently, synthetic biology has been used to answer some very specific questions about the mechanisms underlying differentiation. The work of Matsuda et al. (2015), for example, has provided valuable information about issues of both differentiation and fine-scale patterning via Delta/Notch-mediated lateral inhibition, which is a common mechanism in development (Barad et al., 2011). In this system, cells express the membrane-bound ligand Delta, which signals via Notch receptors on the plasma membrane of neighbouring cells to repress Delta expression in those cells and also to repress a specific pathway of differentiation. The system is intrinsically unstable so that, in an initially homogenous field of cells, cells that happen to activate a little more Delta repress their neighbours and the field breaks up into Delta-high cells, which differentiate one way, and Delta-low cells, which differentiate a different way. In real biological systems, this differentiation is often accompanied by unequal cell division (Zhong et al., 1996), raising the issue of whether clear choices of differentiation path can occur without this feature. To address this, Matsuda et al. constructed a Notch-Delta system in CHO cells, which naturally express Notch but not Delta. They placed an artificial transcriptional repressor under the control of Notch signalling and placed an exogenous Delta and a fluorescent

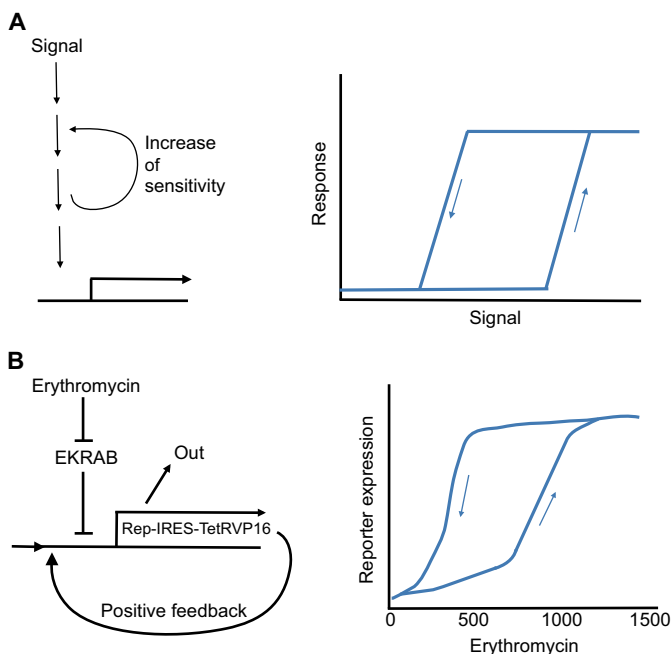

**Fig. 5. Hysteresis emerges from positive feedback in signalling pathways.** (A) Positive feedback in a signalling pathway (left) increases the sensitivity of the pathway once it has been activated. This creates hysteresis (right), in which activation can be maintained by concentrations of signal insufficient to trigger the pathway from the off state. This allows cells to make clear decisions to differentiate in the face of noisy input signals. (B) The network constructed by Kramer and Fussenegger (2005), a synthetic biology-based example of using positive feedback to achieve hysteresis, is depicted. This network (left) consists of a signalling pathway that activates transcription of a gene, which then activates its own transcription by an independent route that adds to any activation via the signalling pathway. This positive feedback leads to strongly hysteretic behaviour of the network (right).

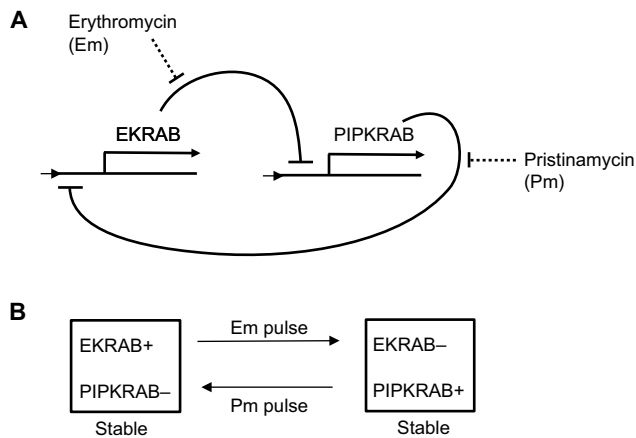

**Fig. 6. A synthetic biology-based example of a stable cell fate change.**

(A) A genetic network, the expression ('differentiation') state of which is self-stabilizing after a transitory inductive stimulus, is shown. The network consists of two transcription inhibitors, EKRAB (*E. coli* macrolide resistance operon repressor E fused to the human trans-silencing domain KRAB) and PIPKRAB (the pristinamycin-responsive version of EKRAB), arranged so that each is on in the absence of inhibition, but each can inhibit the other. (B) The network has two stable states, one in which EKRAB is expressed and PIPKRAB is repressed, and one in which PIPKRAB is expressed and EKRAB is repressed. The use of the small molecules erythromycin (Em) or pristinamycin (Pm) blocks the action of EKRAB or PIPKRAB, respectively, and therefore flips the state of the network. This state is remembered until the other small molecule is given to reverse it.

reporter under the control of a promoter that could be repressed by that transcriptional repressor. However, this system alone was not enough for the cells to generate the Delta-high state; achieving this state required a higher copy number of the repressor, and also a positive-feedback loop based on Notch activation inducing the Lfng protein, which is a natural enhancer of Notch-Delta binding. This created bi-stable differentiation even without asymmetrical cell division. The work therefore addressed the issue of choices of differentiation paths but also highlighted the important role of Lfng in the natural system. More recently, the work of Morsut et al. (2016) has generated a library of synthetic Notch receptors that can sense a range of specific ligands and that should greatly facilitate the construction of systems using contact-mediated control of differentiation.

It should also be mentioned that, as well as systems in which cell state is modified epigenetically, based on concentrations of transcription factors, there have been designs for inducing stable cell state changes via genetic change (e.g. Blenkinson et al., 2007). These are perhaps analogous to specialized differentiation events, such as those seen during lymphocyte maturation.

### The process of morphogenesis

Morphogenesis is the generation of physical form (i.e. shape/anatomy/structure), and it typically, but not always, follows patterning. The morphology that results is a direct determinant of the fitness of an organism in terms of its ability to run, fly, burrow, attract a mate, etc., and is therefore very diverse between different organisms. Morphogenesis, at least at a whole-tissue descriptive level, is therefore probably the least conserved aspect of development.

### Principles of morphogenesis

Morphogenesis has been, so far, less amenable to the pursuit of extracting global principles from specific details. The deep reason for this may be that morphogenesis tends to emerge from the detailed interactions of very large numbers of molecules and cell

behaviours over a variety of scales. Current emphasis is thus more on elucidating mechanisms of morphogenesis rather than overarching principles. Such studies have revealed that most examples of morphogenetic change rely on a fairly small set of basic cellular 'tools', such as proliferation, elective cell death, adhesion-mediated condensation, apical constriction, locomotion, etc., each of which is explained in terms of its own molecular mechanisms (examples of these lists of building blocks can be found in Solnica-Krezel and Sepich, 2012; Davies, 2013). Indeed, it is generally easy to examine a particular developmental event and to analyse it in terms of these behaviours. An apparent ability to explain high-level events in terms of low-level building blocks may, however, give only an illusion of understanding. Predicting the high-level emergent morphogenetic behaviour of synthetic systems assembled from these low-level blocks would be a much more rigorous test (Varenne et al., 2015).

So far, computer modelling has been the main method used to verify predictions of high-level emergent behaviour arising from low-level events, and some very beautiful work has been carried out in this area (e.g. Kuchen et al., 2012; Pascalie et al., 2016). It does, however, suffer from the problem of all simulations, which is that the model may miss features of biological systems, e.g. resource limitations, biochemical bottlenecks and competition for transport channels, that turn out to be very important. Increasing effort is therefore being applied to constructing synthetic biological modules that drive morphogenesis, because these operate in real living cells so are subject to the general constraints of biology.

### Synthetic biology-based approaches to understanding morphogenesis

So far, there have been two main approaches to synthetic morphogenesis (Teague et al., 2016): the creation of completely novel morphogenetic mechanisms based on the operating principles of natural ones; and the creation of genetic modules that can evoke natural morphogenetic behaviours in response to unnatural cues, with the aim of evoking them using synthetic morphogenetic programmes. An example of the first approach has been the creation of novel cell-cell adhesion mechanisms based on cells displaying single-stranded DNA with a specific sequence on their plasma membranes (Todhunter et al., 2015), allowing them to adhere to silanized glass surfaces that bear complementary DNA. Furthermore, if one batch of cells is labelled with a certain DNA sequence and another with its complement, the cells will be mutually adhesive and can be built up onto layers on the surface (Fig. 7A). This synthetic system produced a powerful validation that cell position can be determined by adhesion alone. In recent years, this issue has been explored less than may be supposed. Although early papers on the positioning and sorting of cells assumed the physics of adhesion to be sufficient to prevent cell mixing (Steinberg, 1970), subsequent work implicated the triggering of sophisticated contractile mechanisms at the boundaries between cells expressing different adhesion molecules [see Monier et al. (2011), for an example]. This emphasizes the fact that morphogenetic processes depend on events at the intracellular as well as the intercellular levels.

The second approach is illustrated by the construction of a library of modules, for use in mammalian cells, that trigger specific morphogenetic behaviours such as cell proliferation, apoptosis, syncytium formation, adhesion, dispersal, sorting and locomotion (Fig. 7B) (Cachat et al., 2014). The internal behaviour of the modules makes extensive use of evolved properties of cells: the



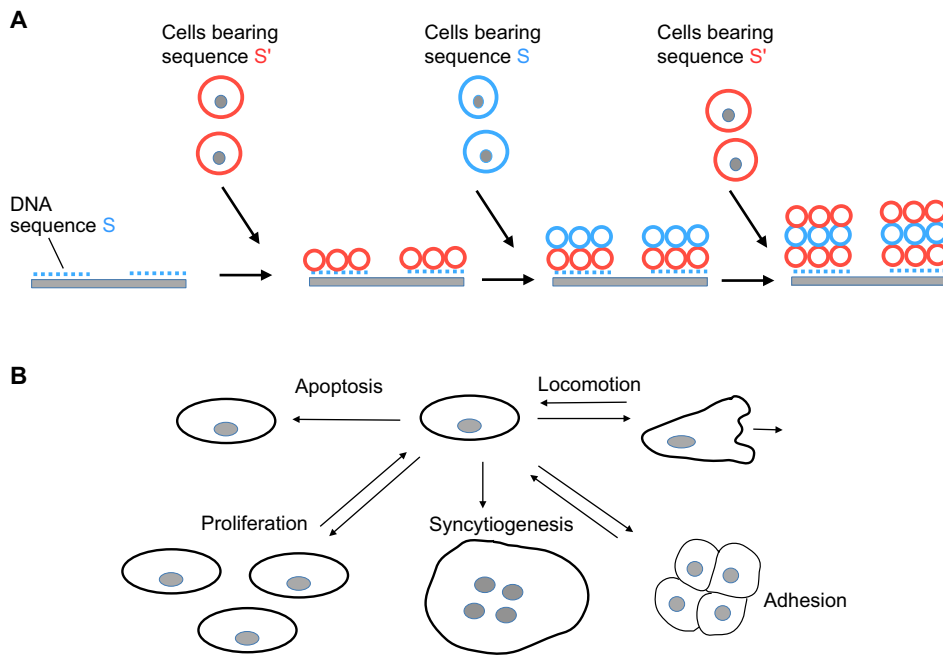

**Fig. 7. Using synthetic biology to understand morphogenesis.** (A) The DNA-based adhesion system of Todhunter et al. (2015) is shown. In this system, complementary DNA strands (S and S', shown in blue and red, respectively) on the surfaces of cells and substrates can drive the formation of multilayered structures. (B) The library of inducible morphogenetic modules, constructed by Cachat et al. (2014), is summarized. These various modules are intended to be controlled by synthetic 'developmental programs'.

point of the library is to allow the behaviours to be triggered in specific orders and placed under the command of synthetic biological genetic systems (Davies and Cachat, 2016). It may be possible, for example, for a morphogenetic module to be linked to a synthetic patterning system such as those described above, to 'reproduce' the natural sequence of 'patterning then morphogenesis'. Modules have also now been constructed that 're-wire' morphogenetic events to respond to purely synthetic controls. An example is the system constructed by Park et al. (2014), which confers on a variety of cells a chemotactic response towards the small molecule clozapine-N-oxide, which is inert to naturally evolved biological systems.

#### Synthetic biology and evo-devo: exploring roads not taken

Testing basic principles is one application of synthetic biology to developmental biology. Another is the use of understanding at its most abstract level to construct synthetic biological systems that explore 'roads not taken' in evolution: solutions to problems that are, as far as we currently know, not used for that purpose in evolved life. Comparing features of evolved and designed solutions to problems may shed interesting light on chance, necessity and evolutionary constraint.

An example of an alternative solution is the production of spot, patch and stripe patterns by constrained phase separation rather than by the mechanisms described in the 'principles of patterning' section above. Production of patterns by incomplete phase separation is similar to the appearance of shallow oily puddles on a road. When oil and water are mixed in a large vessel, the phases separate to reduce overall free energy (by maximizing adhesive water-water molecular interactions rather than 'wasting' them in water-oil contacts). In very shallow liquids, however, the zones of oil that form as the molecules start to separate act as barriers to further coalescence of water because it would be energetically unfavourable for water molecules to enter the oil zones to cross them. The system therefore becomes trapped in a highly patterned local energy minimum and cannot reach the global minimum of complete separation. Living cells of different adhesiveness separate rather like oil and water in an unconstrained system (Steinberg,

1970; Foty and Steinberg, 2005), so it is possible that these, too, might generate complex patterns under constraint. To test this idea, Cachat et al. (2016) constructed two populations of the poorly adhesive HEK239 human cell line, which could be induced by tetracycline to express E-cadherin and P-cadherin, respectively, and which were also labelled with fluorescent proteins. Cultured in the absence of tetracycline, the cells mixed statistically randomly but, on tetracycline induction, they underwent phase separation to form spots or patches, depending on the ratio of cells (Fig. 8A,B). This was true on large 2D surfaces or in large 3D aggregates, but in small 3D aggregates the cells achieved complete separation. The formation of patterns by this type of phase separation has not been described in evolved organisms, perhaps because of its disadvantages of both poor spatial scalability and weakening of the cell sheet at the heterotypic boundaries. Phase separation may, however, be highly relevant to tissue engineering systems that are based on the ability of mixed populations of cells to self-organize into realistic organoids (e.g. Unbekandt and Davies, 2010).

Another synthetic patterning system that seems to be a 'road not taken' uses synthetic coupling of cell density and cell motility to generate stripe patterns (Liu et al., 2011): this is arguably also a type of phase separation, with the phases being motile and stationary. The synthetic system was built in *E. coli* that had been engineered using genes from *Vibrio fischeri* to produce AHL and the AHL-controlled transcriptional regulator receptor LuxR (Liu et al., 2011). The natural chemotaxis Z (cheZ) gene – essential for steady rather than tumbling motility – was deleted from the bacteria and replaced by a cheZ gene under the control of  $\lambda$ cI, which itself was under the control of LuxR (Fig. 8C). Under conditions of low cell density, AHL diffused away, LuxR failed to activate  $\lambda$ cI transcription, cheZ was produced and the bacteria showed high motility. Under conditions of high cell density, AHL concentration rose, LuxR was activated,  $\lambda$ cI was transcribed, cheZ was off and motility was poor. Cells therefore travelled quickly in areas of low density but accumulated in areas of high density, making the density difference even greater. Inoculation of agar with a single colony of these bacteria resulted in a spreading colony arranged in ring-like stripes about 5 mm apart (Fig. 8D). This precise type of patterning seems

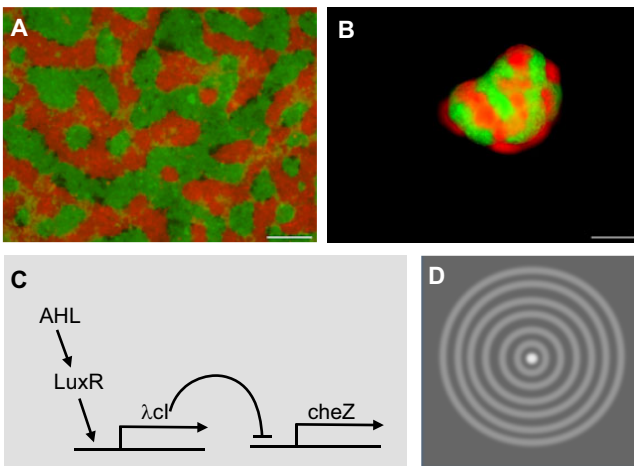

**Fig. 8. Synthetic patterning by ‘roads not taken’ in evolution.** (A,B) Cells engineered to perform patterning by phase separation are shown. When grown in 2D (A), the cells make a flat pattern of patches, whereas they form a 3D pattern of zones when cultured in a hanging drop (B). (C) The synthetic system constructed by Liu et al. (2011) is shown. This system links cell density sensed by AHL concentration to inhibition of motility (via the motility gene *cheZ*): cells in sparse areas are motile but stop moving when they reach crowded areas, resulting in concentric bands as colonies grow (D). AHL, acyl homoserine lactone; *cheZ*, chemotaxis Z;  $\lambda$ cl (cl transcriptional repressor from bacteriophage  $\lambda$ ); LuxR, AHL-activatable activator of the luminescence operon of *V. fischer*. Images courtesy of Elise Cachat (University of Edinburgh, UK).

not to have been discovered in embryos, although it has been noted that the black and yellow pigment cells of zebrafish exhibit so-called ‘run-and-chase’ movements in which black cells withdraw from yellow cells but yellow cells chase black cells. Mutants that affect these movements affect patterning, suggesting that patterns can indeed emerge from this motility (Yamanaka and Kondo, 2014).

### Towards synthetic development

Patterning, differentiation and morphogenesis are sub-components of embryonic development and, as I have highlighted above, the principles of each have already been explored to some extent using synthetic biology approaches. More sophisticated synthetic biology approaches to development will now integrate these aspects. One small step already being taken in this direction in my laboratory is the connection of the system that causes self-patterning to morphogenetic effector modules, in order to create self-patterning morphogenetic systems. In principle at least, many different modules might be combined to create elaborate patterned differentiation and morphogenesis to test sophisticated hypotheses about emergent behaviour and to verify that the final form is indeed as predicted from designed components. In addition, different solutions to the same problem might be compared in terms of speed, scalability, immunity to noise, etc., to inform thinking about the choices made in evolution.

Even fairly modest constructions, without multilayer cycles of patterning, differentiation and morphogenesis, might be used to produce very simple multicellular ‘organisms’ with simple life cycles. Consider, for example, a system proposed a few years ago (Davies, 2008) in which several components – a quorum sensor, a switch with hysteresis, a delay, a motility effector and an adhesion effector – might produce a colonial ‘organism’. Beginning with one cell, this ‘organism’ would grow as cells proliferate, until its size is large enough for quorum sensing to trigger the switch. The switch

would produce three effector molecules. One is the quorum molecule itself, which, being produced now in large amounts, would both achieve hysteresis and drive outlying cells into the same behaviour. The second output of the switch induces the locomotion module, whereas the third silences the switch after a delay. By the time the delay is over, the cells should have dispersed. With locomotion now shut off, each cell can found its own colony until the cycle completes. Many other such designs have been proposed (mostly in conference bars!). If more than one can be built, it may be possible to create small competitive ecosystems, to assess the advantages of multicellularity compared with unicellularity, for example. It may also be possible to design and test systems for predation, parasitism, commensalism and symbiosis in artificial multicellular ‘organisms’ to test principles of development at the ecosystem scale. Synthetic biological approaches to cooperation and symbiosis have already been applied to microorganisms (Shou et al., 2007; Grosskopf and Soyer, 2014; Hays et al., 2015), showing that, in principle, this type of work is possible.

### Conclusions

As this Review has indicated, techniques of synthetic biology have now reached a stage at which it is realistic to use them to build devices based on the core principles of developmental biology, to test whether we have determined those principles correctly. Our long-standing practices of explaining high-level emergent behaviour in terms of simpler underlying principles can now be joined by the practice of constructing low-level devices according to those principles, predicting what the high-level behaviour should be, and testing it.

It should be noted, however, that there is a tendency in the field of synthetic biology to exaggerate the ease with which systems can be constructed by combining simple modules to perform a new function predictably (see Kwok, 2010, for a review of this exaggeration, and Pasotti et al., 2012; Ang et al., 2013; Rekhi and Qutub, 2013; Beal, 2015; Carbonell-Ballester et al., 2016 for recent analysis of specific challenges to predictability and potential strategies for their mitigation). There is also a tendency to assess the success of a project according to the simple question ‘does it work as expected?’. In science, failure can be more instructive than success because it highlights specific deficiencies in current understanding or highlights the importance of apparently peripheral features of a natural system (e.g. apparently functionless binding sites for transcription factors in the genome, discussed in the section about oscillators). As the scientist and author Isaac Asimov famously remarked, ‘The most exciting phrase to hear in science... is not “Eureka!” but “That’s funny...”’. Just as negative results in science are a potentially important but under-reported resource (Sandercock, 2012; van Assen et al., 2014; Matsuda et al., 2015; Weintraub, 2016), ‘engineering failures’ in synthetic biology might become a valuable resource if more were published openly rather than being written off as mis-steps.

Many synthetic systems are designed from first principles, rather than by reference to data from embryos, because their constructors have an engineering mindset and simply want something that works. Can anything useful to development be learned from experience with this type of device? I would argue that it can: having different biological solutions to a problem provides extra perspective, similar to that gained by the study of analogous solutions to a problem shown by different phyla. As having artificial cameras and pumps was helpful in understanding the eye and the heart, so having a wealth of analogous biological devices can prompt questions and, perhaps, highlight evolutionary constraints.

Although unexpected difficulties in building a synthetic system to replicate essential features of a real developmental process may be instructive, the current unpredictability of synthetic design carries with it some real epistemological dangers. Building a system that has known mechanism M, observing that it does not replicate the essential elements of biological event B and concluding that M cannot therefore be the (complete) mechanism of B is one thing; building a system that is designed to have a mechanism M but may in fact either fail to have this mechanism or also interact with the cell by unsuspected mechanisms M', M'', etc., and drawing the same conclusion, is quite another. As in other areas of science, negative conclusions require stronger controls than positive ones, and a great deal of trouble may need to be taken to ensure that the synthetic system operates as intended (which is generally easy because the designer will know what to measure) and does not have unintended consequences on the rest of the cell (which is much more difficult: this may require a full RNA-sequencing-based comparison of normal and engineered cells, possibly at multiple stages of a mechanism's action). Synthetic biologists often strive for orthogonality (non-interaction with cellular mechanisms; see Glossary, Box 1) but this is very difficult to achieve in practice: even when unwanted protein-protein and protein-DNA interactions are rigorously excluded, simple effects on cellular resources and energy pools may be enough to create unexpected effects.

Despite these potential limitations and challenges, it is becoming clear that the intersection between developmental biology and synthetic biology is – and will continue to be – fruitful. In addition, developmental biology now has strong applied aspects, such as regenerative medicine and tissue engineering, and synthetic biology is being applied to these too. Indeed, many of the approaches taken in these applied fields rely on the application of developmental principles as they are currently understood. For a technologist, the failure of some device to work is a frustrating, back-to-the-drawing-board experience but, to the 'pure' developmental biologist, news of the failure may have very important implications for revising basic understanding. It will therefore be in the interest of everybody that stem cell technologists and tissue engineers be encouraged to publish their failures, and that there is always a rich dialogue between the pure and applied aspects of our science.

The mathematician Benoit Mandelbrot urged his readers 'Think not of what you see, but what it took to produce what you see' (Mandelbrot, 2012). Developmental biologists have always done this, but now we have access to new and powerful tools (when used wisely) that can help guide our thoughts.

#### Acknowledgements

The author is grateful to Dr Elise Cachat for images shown in Fig. 8.

#### Competing interests

The author declares no competing or financial interests.

#### Funding

The author's work in applying synthetic biology to development is funded by the Biotechnology and Biological Sciences Research Council (BB/G016658/1; BB/M018040/1) and the Leverhulme Trust (RPG-2012-558).

#### References

- Akam, M.** (1987). The molecular basis for metamerism in the *Drosophila* embryo. *Development* **101**, 1-22.
- Ang, J., Harris, E., Hussey, B. J., Kil, R. and McMillen, D. R.** (2013). Tuning response curves for synthetic biology. *ACS Synth. Biol.* **2**, 547-567.
- Angeli, D., Ferrell, J. E. Jr and Sontag, E. D.** (2004). Detection of multistability, bifurcations, and hysteresis in a large class of biological positive-feedback systems. *Proc. Natl. Acad. Sci. USA* **101**, 1822-1827.
- Ashe, H. L. and Briscoe, J.** (2006). The interpretation of morphogen gradients. *Development* **133**, 385-394.
- Asimov, I.** (1979). *A Short History of Chemistry*. New York, USA: Preager. ISBN 978-0313207693.
- Barad, O., Hornstein, E. and Barkai, N.** (2011). Robust selection of sensory organ precursors by the Notch-Delta pathway. *Curr. Opin. Cell Biol.* **23**, 663-667.
- Basu, S., Gerchman, Y., Collins, C. H., Arnold, F. H. and Weiss, R.** (2005). A synthetic multicellular system for programmed pattern formation. *Nature* **434**, 1130-1134.
- Beal, J.** (2015). Signal-to-noise ratio measures efficacy of biological computing devices and circuits. *Front. Bioeng. Biotechnol.* **3**, 93.
- Blagodatskya, A., Sergeev, A., Kryuchkova, M., Lopatin, Y. and Katanaev, V. L.** (2015). Diverse set of Turing nanopatterns coat cornea across insect lineages. *Proc. Natl. Acad. Sci. USA* **112**, 10750-10755.
- Blenkiron, M., Arvind, D. K. and Davies, J. A.** (2007). Design of an irreversible DNA memory element. *Nat. Comput.* **6**, 403-411.
- Briscoe, J. and Ericson, J.** (2001). Specification of neuronal fates in the ventral neural tube. *Curr. Opin. Neurobiol.* **11**, 43-49.
- Briscoe, J. and Small, S.** (2015). Morphogen rules: design principles of gradient-mediated embryo patterning. *Development* **142**, 3996-4009.
- Cachat, E., Liu, W., Hohenstein, P. and Davies, J. A.** (2014). A library of mammalian effector modules for synthetic morphology. *J. Biol. Eng.* **8**, 26.
- Cachat, E., Liu, W., Martin, K. C., Yuan, X., Yin, H., Hohenstein, P. and Davies, J. A.** (2016). 2- and 3-dimensional synthetic large-scale de novo patterning by mammalian cells through phase separation. *Sci. Rep.* **6**, 20664.
- Campos-Ortega, J. A.** (1995). Genetic mechanisms of early neurogenesis in *Drosophila melanogaster*. *Mol. Neurobiol.* **10**, 75-89.
- Carbonell-Ballestero, M., Garcia-Ramallo, E., Montañez, R., Rodriguez-Caso, C. and Macía, J.** (2016). Dealing with the genetic load in bacterial synthetic biology circuits: convergences with the Ohm's law. *Nucleic Acids Res.* **44**, 496-507.
- Cotterell, J. and Sharpe, J.** (2010). An atlas of gene regulatory networks reveals multiple three-gene mechanisms for interpreting morphogen gradients. *Mol. Syst. Biol.* **6**, 425.
- Crick, F.** (1970). Diffusion in embryogenesis. *Nature* **225**, 420-422.
- Dalcq, A.** (1938). *Form and Causality in Early Development*. Cambridge: Cambridge Univ. Press.
- Danino, T., Mondragón-Palmino, O., Tsimring, L. and Hasty, J.** (2010). A synchronized quorum of genetic clocks. *Nature* **463**, 326-330.
- Davies, J. A.** (2008). Synthetic morphology: prospects for engineered, self-constructing anatomies. *J. Anat.* **212**, 707-719.
- Davies, J. A.** (2013). *Mechanisms of Morphogenesis*. London: Academic Press.
- Davies, J. A. and Cachat, E.** (2016). Synthetic biology meets tissue engineering. *Biochem. Soc. Trans.* **44**, 696-701.
- d'Espaux, L., Mendez-Perez, D., Li, R. and Keasling, J. D.** (2015). Synthetic biology for microbial production of lipid-based biofuels. *Curr. Opin. Chem. Biol.* **29**, 58-65.
- Dessaud, E., Yang, L. L., Hill, K., Cox, B., Ulloa, F., Ribeiro, A., Mynett, A., Novitsch, B. G. and Briscoe, J.** (2007). Interpretation of the sonic hedgehog morphogen gradient by a temporal adaptation mechanism. *Nature* **450**, 717-720.
- Driever, W., Thoma, G. and Nüsslein-Volhard, C.** (1989). Determination of spatial domains of zygotic gene expression in the *Drosophila* embryo by the affinity of binding sites for the bicoid morphogen. *Nature* **340**, 363-367.
- Economou, A. D., Ohazama, A., Porntaveetus, T., Sharpe, P. T., Kondo, S., Basson, M. A., Gritli-Linde, A., Cobourne, M. T. and Green, J. B. A.** (2012). Periodic stripe formation by a Turing mechanism operating at growth zones in the mammalian palate. *Nat. Genet.* **44**, 348-351.
- Elowitz, M. B. and Leibler, S.** (2000). A synthetic oscillatory network of transcriptional regulators. *Nature* **403**, 335-338.
- Ferrell, J. E. Jr and Machleder, E. M.** (1998). The biochemical basis of an all-or-none cell fate switch in *Xenopus* oocytes. *Science* **280**, 895-898.
- Foty, R. A. and Steinberg, M. S.** (2005). The differential adhesion hypothesis: a direct evaluation. *Dev. Biol.* **278**, 255-263.
- Gao, X. J. and Elowitz, M. B.** (2016). Synthetic biology: precision timing in a cell. *Nature* **538**, 462-463.
- Gierer, A. and Meinhardt, H.** (1972). A theory of biological pattern formation. *Kybernetik* **12**, 30-39.
- Greber, D. and Fussenegger, M.** (2010). An engineered mammalian band-pass network. *Nucleic Acids Res.* **38**, e174.
- Grosskopf, T. and Soyer, O. S.** (2014). Synthetic microbial communities. *Curr. Opin. Microbiol.* **18**, 72-77.
- Gurdon, J. B., Mitchell, A. and Mahony, D.** (1995). Direct and continuous assessment by cells of their position in a morphogen gradient. *Nature* **376**, 520-521.
- Hays, S. G., Patrick, W. G., Ziesack, M., Oxman, N. and Silver, P. A.** (2015). Better together: engineering and application of microbial symbioses. *Curr. Opin. Biotechnol.* **36**, 40-49.

- Huang, S., Guo, Y.-P., May, G. and Enver, T. (2007). Bifurcation dynamics in lineage-commitment in bipotent progenitor cells. *Dev. Biol.* **305**, 695-713.
- Hurley, J. M., Loros, J. J. and Dunlap, J. C. (2016). Circadian oscillators: around the transcription-translation feedback loop and on to output. *Trends Biochem. Sci.* **41**, 834-846.
- Hussain, F., Gupta, C., Hirning, A. J., Ott, W., Matthews, K. S., Josic, K. and Bennett, M. R. (2014). Engineered temperature compensation in a synthetic genetic clock. *Proc. Natl. Acad. Sci. USA* **111**, 972-927.
- Hutmacher, D. W., Holzapfel, B. M., De-Juan-Pardo, E. M., Pereira, B. A., Ellem, S. J., Loessner, D. and Risbridger, G. P. (2015). Convergence of regenerative medicine and synthetic biology to develop standardized and validated models of human diseases with clinical relevance. *Curr. Opin. Biotechnol.* **35**, 127-132.
- Johnson, A. D., Poteete, A. R., Lauer, G., Sauer, R. T., Ackers, G. K. and Ptashne, M. (1981). lambda Repressor and cro—components of an efficient molecular switch. *Nature* **294**, 217-223.
- Kauffman, S. A. (1993). *The Origins of Order*. Oxford, UK: Oxford University Press.
- Kramer, B. P. and Fussenegger, M. (2005). Hysteresis in a synthetic mammalian gene network. *Proc. Natl. Acad. Sci. USA* **102**, 9517-9522.
- Kramer, B. P., Viretta, A. U., Daoud-El-Baba, M., Aubel, D., Weber, W. and Fussenegger, M. (2004). An engineered epigenetic transgene switch in mammalian cells. *Nat. Biotechnol.* **22**, 867-870.
- Kuchen, E. E., Fox, S., de Reuille, P. B., Kennaway, R., Bensmihen, S., Avondo, J., Calder, G. M., Southam, P., Robinson, S., Bangham, A. et al. (2012). Generation of leaf shape through early patterns of growth and tissue polarity. *Science* **335**, 1092-1096.
- Kutejova, E., Briscoe, J. and Kicheva, A. (2009). Temporal dynamics of patterning by morphogen gradients. *Curr. Opin. Genet. Dev.* **19**, 315-322.
- Kwok, R. (2010). Five hard truths for synthetic biology. *Nature* **463**, 288-290.
- Leduc, S. (1912). *La Biologie Synthétique, Étude de Biophysique*. Paris: Poinat.
- Lewis, J. (2003). Autoinhibition with transcriptional delay: a simple mechanism for the zebrafish somitogenesis oscillator. *Curr. Biol.* **19**, 1398-1408.
- Liu, C., Fu, X., Liu, L., Ren, X., Chau, C. K., Li, S., Xiang, L., Zeng, H., Chen, G., Tang, L.-H. et al. (2011). Sequential establishment of stripe patterns in an expanding cell population. *Science* **334**, 238-241.
- MacQuarrie, K. L., Fong, A. P., Morse, R. H. and Tapscott, S. J. (2011). Genome-wide transcription factor binding: beyond direct target regulation. *Trends Genet.* **27**, 141-148.
- Mandelbrot, B. (2012). *The Fractalist: Memoir of a Scientific Maverick*. New York: Pantheon.
- Matsuda, M., Koga, M., Woltjen, K., Nishida, E. and Ebisuya, M. (2015). Synthetic lateral inhibition governs cell-type bifurcation with robust ratios. *Nat. Commun.* **6**, 6195.
- Monier, B., Pélissier-Monier, A. and Sanson, B. (2011). Establishment and maintenance of compartmental boundaries: role of contractile actomyosin barriers. *Cell. Mol. Life Sci.* **68**, 1897-1910.
- Monk, N. A. M. (2003). Oscillatory expression of Hes1, p53, and NF-kappaB driven by transcriptional time delays. *Curr. Biol.* **13**, 1409-1413.
- Morsut, L., Roybal, K. T., Xiong, X., Gordley, R. M., Coyle, S. M., Thomson, M. and Lim, W. A. (2016). Engineering customized cell sensing and response behaviors using synthetic notch receptors. *Cell* **164**, 780-791.
- Müller, P., Rogers, K. W., Jordan, B. M., Lee, J. S., Robson, D., Ramanathan, S. and Schier, A. F. (2012). Differential diffusivity of Nodal and Lefty underlies a reaction-diffusion patterning system. *Science* **336**, 721-724.
- Niederholtmeyer, H., Sun, Z. Z., Hori, Y., Yeung, E., Verpoorte, A., Murray, R. M. and Maerkl, S. J. (2015). Rapid cell-free forward engineering of novel genetic ring oscillators. *Elife* **4**, e09771.
- Oates, A. C., Morelli, L. G. and Ares, S. (2012). Patterning embryos with oscillations: structure, function and dynamics of the vertebrate segmentation clock. *Development* **139**, 625-639.
- Park, J. S., Rhau, B., Hermann, A., McNally, K. A., Zhou, C., Gong, D., Weiner, O. D., Conklin, B. R., Onuffer, J. and Lim, W. A. (2014). Synthetic control of mammalian-cell motility by engineering chemotaxis to an orthogonal bioinert chemical signal. *Proc. Natl. Acad. Sci. USA* **111**, 5896-5901.
- Pascalie, J., Potier, M., Kowaliw, T., Giavitto, J.-L., Michel, O., Spicher, A. and Doursat, R. (2016). Developmental design of synthetic bacterial architectures by morphogenetic engineering. *ACS Synth. Biol.* **5**, 842-861.
- Pasotti, L., Politi, N., Zucca, S., Cusella De Angelis, M. G. and Magni, P. (2012). Bottom-up engineering of biological systems through standard bricks: a modularity study on basic parts and devices. *PLoS ONE* **7**, e39407.
- Piccolino, M. (1997). Luigi Galvani and animal electricity: two centuries after the foundation of electrophysiology. *Trends Neurosci.* **20**, 443-448.
- Potvin-Trottier, L., Lord, N. D., Vinnicombe, G. and Paulsson, J. (2016). Synchronous long-term oscillations in a synthetic gene circuit. *Nature* **538**, 514-517.
- Raff, M. C. (1992). Social controls on cell survival and cell death. *Nature* **356**, 397-400.
- Raspopovic, J., Marcon, L., Russo, L. and Sharpe, J. (2014). Modeling digits. Digit patterning is controlled by a Bmp-Sox9-Wnt Turing network modulated by morphogen gradients. *Science* **345**, 566-570.
- Rekhi, R. and Qutub, A. A. (2013). Systems approaches for synthetic biology: a pathway toward mammalian design. *Front. Physiol.* **4**, 285.
- Richmond, D. L. and Oates, A. C. (2012). The segmentation clock: inherited trait or universal design principle? *Curr. Opin. Genet. Dev.* **22**, 600-606.
- Ro, D.-K., Paradise, E. M., Ouellet, M., Fisher, K. J., Newman, K. L., Ndungu, J. M., Ho, K. A., Eachus, R. A., Ham, T. S., Kirby, J. et al. (2006). Production of the antimalarial drug precursor artemisinic acid in engineered yeast. *Nature* **440**, 940-943.
- Ruder, W. C., Lu, T. and Collins, J. J. (2011). Synthetic biology moving into the clinic. *Science* **333**, 1248-1252.
- Sandercock, P. (2012). Negative results: why do they need to be published? *Int. J. Stroke* **7**, 32-33.
- Shimojo, H. and Kageyama, R. (2016). Oscillatory control of Delta-like1 in somitogenesis and neurogenesis: a unified model for different oscillatory dynamics. *Semin. Cell Dev. Biol.* **49**, 76-82.
- Shou, W., Ram, S. and Vilar, J. M. G. (2007). Synthetic cooperation in engineered yeast populations. *Proc. Natl. Acad. Sci. USA* **104**, 1877-1882.
- Sick, S., Reinker, S., Timmer, J. and Schlake, T. (2006). WNT and DKK determine hair follicle spacing through a reaction-diffusion mechanism. *Science* **314**, 1447-1450.
- Sohka, T., Heins, R. A., Phelan, R. M., Greisler, J. M., Townsend, C. A. and Ostermeier, M. (2009). An externally tunable bacterial band-pass filter. *Proc. Natl. Acad. Sci. USA* **106**, 10135-10140.
- Solnica-Krezel, L. and Sepich, D. S. (2012). Gastrulation: making and shaping germ layers. *Annu. Rev. Cell Dev. Biol.* **28**, 687-717.
- Steinberg, M. S. (1970). Does differential adhesion govern self-assembly processes in histogenesis? Equilibrium configurations and the emergence of a hierarchy among populations of embryonic cells. *J. Exp. Zool.* **173**, 395-433.
- Stricker, J., Cookson, S., Bennett, M. R., Mather, W. H., Tsimring, L. S. and Hasty, J. (2008). A fast, robust and tunable synthetic gene oscillator. *Nature* **456**, 516-519.
- Swinburne, I. A., Miguez, D. G., Landgraf, D. and Silver, P. A. (2008). Intron length increases oscillatory periods of gene expression in animal cells. *Genes Dev.* **22**, 2342-2346.
- Teague, B. P., Guye, P., and Weiss, R. (2016). Synthetic morphogenesis. *Cold Spring Harb. Perspect Biol.* a023929.
- Thompson, D. W. (1917). *On Growth and form*. Cambridge, UK: Cambridge University Press.
- Todhunter, M. E., Jee, N. Y., Hughes, A. J., Coyle, M. C., Cerchiari, A., Farlow, J., Garbe, J. C., LaBarge, M. A., Desai, T. A. and Gartner, Z. J. (2015). Programmed synthesis of three-dimensional tissues. *Nat. Methods* **12**, 975-981.
- Traube, M. (1866). Über homogene Membranen und deren Einfluß auf die Endosmose. *Vorläufige Mitteilungen. Zentralblatt f. d. med. Wissenschaften Nr. 7 u. 8*.
- Turing, A. M. (1952). The chemical basis of morphogenesis. *Phil. Trans. R. Soc. Lond.* **237**, 37-72.
- Unbekandt, M. and Davies, J. A. (2010). Dissociation of embryonic kidneys followed by reaggregation allows the formation of renal tissues. *Kidney Int.* **77**, 407-416.
- Uriu, K. (2016). Genetic oscillators in development. *Dev. Growth Differ.* **58**, 16-30.
- van Assen, M. A. L. M., van Aert, R. C. M., Nuijten, M. B. and Wicherts, J. M. (2014). Why publishing everything is more effective than selective publishing of statistically significant results. *PLoS ONE* **9**, e84896.
- Varenne, F., Chaigneau, P., Petitot, J. and Doursat, R. (2015). Programming the emergence in morphogenetically architected complex systems. *Acta Biotheor.* **63**, 295-308.
- Waddington, C. H. (1957). *The Strategy of the Genes*. London, UK: George Allen and Unwin.
- Webster, D. P., TerAvest, M. A., Doud, D. F. R., Chakravorty, A., Holmes, E. C., Radens, C. M., Sureka, S., Galnick, J. A. and Angenent, L. T. (2014). An arsenic-specific biosensor with genetically engineered *Shewanella oneidensis* in a bioelectrochemical system. *Biosens. Bioelectron.* **62**, 320-324.
- Weintraub, P. G. (2016). The importance of publishing negative results. *J. Insect. Sci.* **23**, 16.
- Wolpert, L. (1969). Positional information and the spatial pattern of cellular differentiation. *J. Theor. Biol.* **25**, 1-47.
- Xiong, W. and Ferrell, J. E. Jr (2003). A positive-feedback-based bistable 'memory module' that governs a cell fate decision. *Nature* **426**, 460-465.
- Yabe, T. and Takada, S. (2016). Molecular mechanism for cyclic generation of somites: lessons from mice and zebrafish. *Dev. Growth Differ.* **58**, 31-42.
- Yamanaka, H. and Kondo, S. (2014). In vitro analysis suggests that difference in cell movement during direct interaction can generate various pigment patterns in vivo. *Proc. Natl. Acad. Sci. USA* **111**, 1867-1872.
- Yang, Y., Drossopoulou, G., Chuang, P. T., Duprez, D., Marti, E., Bumcrot, D., Vargesson, N., Clarke, J., Niswander, L., McMahon, A. et al. (1997). Relationship between dose, distance and time in Sonic Hedgehog-mediated

- regulation of anteroposterior polarity in the chick limb. *Development* **124**, 4393-4404.
- Zhang, C.-C., Laurent, S., Sakr, S., Peng, L. and Bédou, S.** (2006). Heterocyst differentiation and pattern formation in cyanobacteria: a chorus of signals. *Mol. Microbiol.* **9**, 367-375.
- Zhao, X., Cho, H., Yu, R. T., Atkins, A. R., Downes, M. and Evans, R. M.** (2014). Nuclear receptors rock around the clock. *EMBO Rep.* **15**, 518-528.
- Zhong, W., Feder, J. N., Jiang, M.-M., Jan, L. Y. and Jan, Y. N.** (1996). Asymmetric localization of a mammalian numb homolog during mouse cortical neurogenesis. *Neuron* **17**, 43-53.