

EVIDENCE THAT ACETYLCHOLINE IS AN INHIBITORY TRANSMITTER OF HEART INTERNEURONS IN THE LEECH

By JOACHIM SCHMIDT AND RONALD L. CALABRESE

Department of Biology, Emory University, 1510 Clifton Road, Atlanta, GA 30322, USA

Accepted 6 July 1992

Summary

1. In the leech, synaptic transmission between heart interneurons (HN cells) and between HN cells and heart motor neurons (HE cells) is blocked by bicuculline methiodide.
2. Gamma-aminobutyric acid, when applied focally onto the somata of HN cells or when added to the superfusate, has no effect on the membrane potential of HN cells.
3. Both acetylcholine (ACh) and the ACh agonist carbachol hyperpolarize HN cells and HE cells when applied focally onto their somata or into the neuropil or when added to the superfusate.
4. Inhibitory postsynaptic-potential-like responses elicited by focal application of carbachol onto the somata of HN cells and HE cells are blocked by bicuculline methiodide and are reversed when Cl^- is injected into the cells.
5. Focal application of carbachol onto the somata of HN cells and HE cells increases membrane conductance.
6. The results indicate that HN cells use ACh as an inhibitory transmitter, that the postsynaptic receptors for ACh are blocked by bicuculline methiodide and that inhibition of HN cells and HE cells is mediated by an increased Cl^- conductance.

Introduction

In the circulatory system of the leech, blood is moved by rhythmic constrictions of two lateral muscular vessels, the 'heart tubes'. The heart tubes are innervated by bilateral pairs of motor neurons, the HE cells. HE cells are located in the third to the eighteenth ganglia (Thompson and Stent, 1976a; Calabrese, 1977). Rhythmic bursts of action potentials in HE cells cause constrictions of the heart tubes and entrain the heart tube's inherent constriction rhythm to match the period of HE cell cycling (Maranto and Calabrese, 1984). The inherent tonic activity of HE cells is organized into rhythmic bursts of action potentials by rhythmic inhibitory input from interneurons of the heartbeat pattern generator, HN cells (Calabrese, 1979).

Key words: leech, heartbeat interneurons, acetylcholine, bicuculline methiodide, *Hirudo medicinalis*.

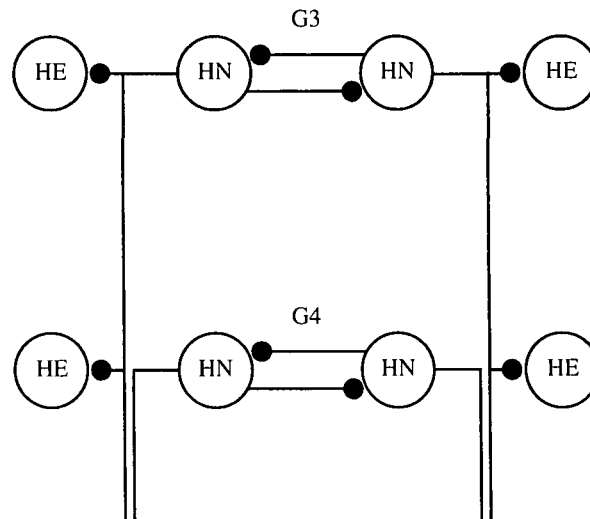

Fig. 1. Connectivity of HN cells and HE cells in the third (G3) and fourth ganglia (G4). Large open circles represent neurons, lines represent major neurites or axons and small filled circles indicate inhibitory chemical synapses. HN cells in the third and fourth ganglia also form ipsilateral reciprocal inhibitory connections with HN cells in the first and second ganglia that are not shown in the diagram. Connections of HN cells with HE cells in more posterior ganglia are not shown.

Each of the first seven segmental ganglia of the leech central nervous system (CNS) contains a pair of HN interneurons, which form a network of inhibitory connections (Thompson and Stent, 1976*b,c*; Calabrese, 1977). The first four pairs of HN cells contribute to rhythm generation, whereas the others seem to be involved solely in the intersegmental coordination of HE motor neurons (Peterson and Calabrese, 1982). Of particular interest are the HN cells in the third and fourth ganglia, HN(3) and HN(4). HN(3) and HN(4) cell pairs appear to be dominant in pacing the heartbeat timing oscillator while HN(1) and HN(2) cells serve as coordinating fibers (Peterson, 1983). HN(3) cells and HN(4) cells form reciprocal inhibitory synapses across the ganglion (Fig. 1; Thompson and Stent, 1976*c*). They generate rhythmic alternating bursts of spikes (see Fig. 2A) as a result of mutual inhibition (Peterson, 1983; Calabrese *et al.* 1989). Transmission between these neurons is not only spike-mediated but also involves a graded component (Calabrese *et al.* 1989; Angstadt and Calabrese, 1991). Inhibitory interaction of HN cells takes place at synapses on fine neurites near the midline region of the ganglion (Tolbert and Calabrese, 1985). The rhythmic output of HN(3) and HN(4) cells inhibits heart motor neurons and other heart interneurons. HN(3) cells inhibit ipsilateral heart motor neurons of the third and the fourth ganglia and of more posterior ganglia. HN(4) cells inhibit ipsilateral motor neurons of the fifth ganglion and of more posterior ganglia (Fig. 1; Thompson and Stent, 1976*b*; Calabrese, 1977). The IPSPs elicited by HN cells in the contralateral HN cell and

in HE cells appear to be mediated by an increase in Cl^- conductance (Calabrese, 1979; Nicholls and Wallace, 1978).

Although we have a thorough knowledge of the connectivity of HN cells and of the mechanisms of interaction between HN cells, the transmitter that they use is still not known. By focusing on HN(3) and HN(4) cells, this study was undertaken to identify the transmitter of HN cells.

Materials and methods

Leeches (*Hirudo medicinalis* L.) were obtained from Leeches USA (New York) and maintained in artificial pond water at 15°C. Animals were anesthetized in cold saline and the third and fourth ganglia were removed for study.

Individual ganglia were pinned ventral side up in a Petri dish lined with Sylgard (Dow-Corning) with a bath volume of 0.5 ml. The connective tissue sheath overlying the nerve cell bodies was removed immediately prior to the experiments. Ganglia were continuously superfused (1.5–2 ml min⁻¹) with normal leech saline (Nicholls and Baylor, 1968) containing (in mmol l⁻¹): NaCl, 115; KCl, 4; CaCl₂, 1.8; glucose, 10; Tris buffer, 10; adjusted to pH 7.4 with HCl. In many of the experiments 'Na⁺-free saline' was used to suppress spike activity. In these cases an equimolar concentration of *N*-methyl-D-glucamine (NMDG) was substituted for Na⁺. Some experiments were performed in 'Na⁺- and Ca²⁺-free saline' in which an additional substitution of equimolar amounts of CoCl₂ replaced CaCl₂ in order to block Ca²⁺ currents. Bicuculline methiodide (two different batches were used), picrotoxin, carbachol, acetyl-beta-metacholine, pilocarpine, gamma-aminobutyric acid (GABA), glycine, glutamate, histamine, serotonin, octopamine, neostigmine and eserine, all from Sigma, were added to the saline without compensation for osmotic strength.

In some experiments, acetylcholine chloride (ACh) or carbachol was applied focally to receptors on the soma of HN cells and HE cells or more rarely into the neuropil with a picospritzer (General Valve, Picospritzer II). The drugs were used in concentrations of 10⁻³ or 10⁻⁴ mol l⁻¹ and were dissolved in the saline used for superfusion. Pipettes for spritzing (borosilicate glass, 1 mm o.d., 0.75 mm i.d.) were pulled on a pipette puller (Flaming Brown Micropipette Puller, model P-80/PC, Sutter Instruments Co.) with resistances of 25–50 MΩ with the above-mentioned drug solutions.

Cell bodies of HN cells and HE cells were penetrated with microelectrodes made of the same glass as above filled with 4 mol l⁻¹ potassium acetate/22 mmol l⁻¹ KCl solution with resistances of 30–40 MΩ. An Axoclamp 2A amplifier (Axon Instruments) was used in BRIDGE mode for recording or in DCC mode (discontinuous current-clamp) for current-clamp experiments. Sample rates in DCC mode typically were in the range of 2–3 kHz. Unless indicated otherwise, all experiments were carried out at least three times.

Data were recorded on a VHS video cassette recorder modified for FM recording (Vetter, model 240) for later playback on paper chart recorders

(Gould). Single events of interest (inhibitory postsynaptic potentials, IPSPs) were digitized on line, stored and analyzed on a personal computer using pClamp software (Axon Instruments). Digitized data were displayed on a laserprinter (Hewlett Packard, LaserJet III).

Results

Is GABA a transmitter of HN cells?

Gamma-aminobutyric acid (GABA) is a well-known inhibitory transmitter in vertebrates and invertebrates. In each segmental ganglion of the leech about 35 neurons have a high-affinity GABA uptake system and, therefore, may use GABA as a transmitter (Cline, 1983).

To test whether GABA is a transmitter of HN cells, recordings from single HN cells were made first in normal saline and then while the ganglion was superfused with saline containing GABA (10^{-4} mol l $^{-1}$). In other experiments recordings were made from HN cells in Na $^{+}$ -free saline (to avoid spike activity and to obtain a constant membrane potential) and GABA (10^{-4} mol l $^{-1}$ in saline) was applied focally with a picospritzer into the neuropil in the midline region where HN–HN synapses could be expected (Tolbert and Calabrese, 1985) or onto the somata of HN cells. In neither set of experiments was a significant change in the mean membrane potential observed with GABA application.

GABA (10^{-4} mol l $^{-1}$) hyperpolarizes motor neurons of longitudinal muscles of the leech by increasing Cl $^{-}$ conductance when applied focally onto the somata or into the neuropil (Cline, 1986). Thus, activation of GABA receptors should have hyperpolarized the HN cells. The negative result indicates that GABA is not a transmitter of HN cells.

A negative result was also obtained when picrotoxin (10^{-4} mol l $^{-1}$), which is known to be a competitive GABA antagonist in other systems, was added to the superfusate. IPSPs in HN cells did not appear to be depressed.

The experiments described above indicate that GABA is not a transmitter in HN cells. This result is supported by experiments in which the GABA uptake by leech neurons was measured; GABA uptake by HN cells and HE cells was not detected (Cline, 1983).

Bicuculline methiodide blocks synaptic transmission

Bicuculline methiodide has been shown to be a strong GABA antagonist (Pong and Graham, 1972). In the leech, bicuculline methiodide reversibly blocks responses to GABA application in the motor neurons of longitudinal muscles (Cline, 1986).

We found that bicuculline methiodide effectively blocked mutual inhibition of HN cells as shown in Fig. 2. The activity of two HN cells of the third ganglion was recorded simultaneously. After superfusing the ganglion with saline containing bicuculline methiodide (10^{-4} mol l $^{-1}$) for about a minute, the normal alternating burst pattern (Fig. 2A) of the HN(3) cell pair was completely abolished and both

cells discharged tonically (Fig. 2B). The normal rhythmic discharge pattern was re-established by superfusing the ganglion with normal saline (Fig. 2C). Bicuculline methiodide effectively reduced IPSP size. Usually IPSPs were not completely abolished, as shown in Fig. 2E (after 5 min of bicuculline methiodide superfusion).

To test whether graded transmission between HN cells is also blocked by bicuculline methiodide, the activity of two HN cells was recorded simultaneously while the ganglion was bathed in Na^+ -free saline. In Na^+ -free saline, plateau potentials can be elicited in HN cells without the appearance of spikes. Upon release from hyperpolarization, an HN neuron forms a prolonged Ca^{2+} -dependent plateau potential (Fig. 3A, lower trace; Arbas and Calabrese, 1987; Angstadt and Calabrese, 1991). Each plateau potential elicits an IPSP in the contralateral HN cell (Fig. 3A, upper trace). These IPSPs were blocked reversibly when bicuculline methiodide ($10^{-4} \text{ mol l}^{-1}$) was added to the superfusate (Fig. 3B,C). The size of the IPSPs was reduced by about 80 %, as shown in Fig. 3D,E.

Not only is mutual inhibition between HN cells blocked by bicuculline methiodide but transmission between HN cells and HE cells is also blocked. The block of HN-HE cell transmission is shown in a simultaneous recording of an HN(3) cell and the ipsilateral HE(3) cell (Fig. 4B). The HE(3) cell is not only inhibited by an HN(3) cell but also by an unidentified HN(X) cell (Thompson and Stent, 1976*b*). Inhibitory input from two sources is apparent in Fig. 4A,C since HN(3) bursts do not exactly match the inhibitory phase between HE(3) bursts. The IPSPs elicited by HN(3) appear mainly during bursting of the HE(3) cell. The inhibitory phase between the HE bursts is mainly a result of HN(X) input to the HE(3) cell.

After about a minute of superfusion with saline containing bicuculline methiodide ($10^{-4} \text{ mol l}^{-1}$) the typical coupled bursting pattern of the HE(3) cell and the HN(3) cell disappeared (Fig. 4B). After the ganglion had been washed with normal saline the bursting pattern of both neurons was restored (Fig. 4C). The large reduction in IPSP amplitude caused by bicuculline methiodide in the HE(3) cell is shown in Fig. 4D,E.

The block of inhibition with bicuculline methiodide as an indicator of the use of GABA as a transmitter is in contrast to the negative results obtained with direct GABA application and with picrotoxin ($10^{-4} \text{ mol l}^{-1}$). Bicuculline methiodide has been found to block GABA-mediated inhibition in the leech (Cline, 1986). Since all other experiments to identify GABA as a transmitter of HN cells failed, it appears that bicuculline methiodide not only blocks GABA-mediated responses but also those mediated by another transmitter.

Are HN cell synapses cholinergic?

Several transmitter candidates were tested: glycine, glutamate, serotonin, histamine and octopamine. Substances were applied focally to the somata of HN and HE cells at concentrations of $10^{-3} \text{ mol l}^{-1}$, while the activity of these cells was recorded. Experiments were carried out in Na^+ -free saline in which Ca^{2+} was substituted by equimolar amounts of Co^{2+} to block synaptic transmission and to

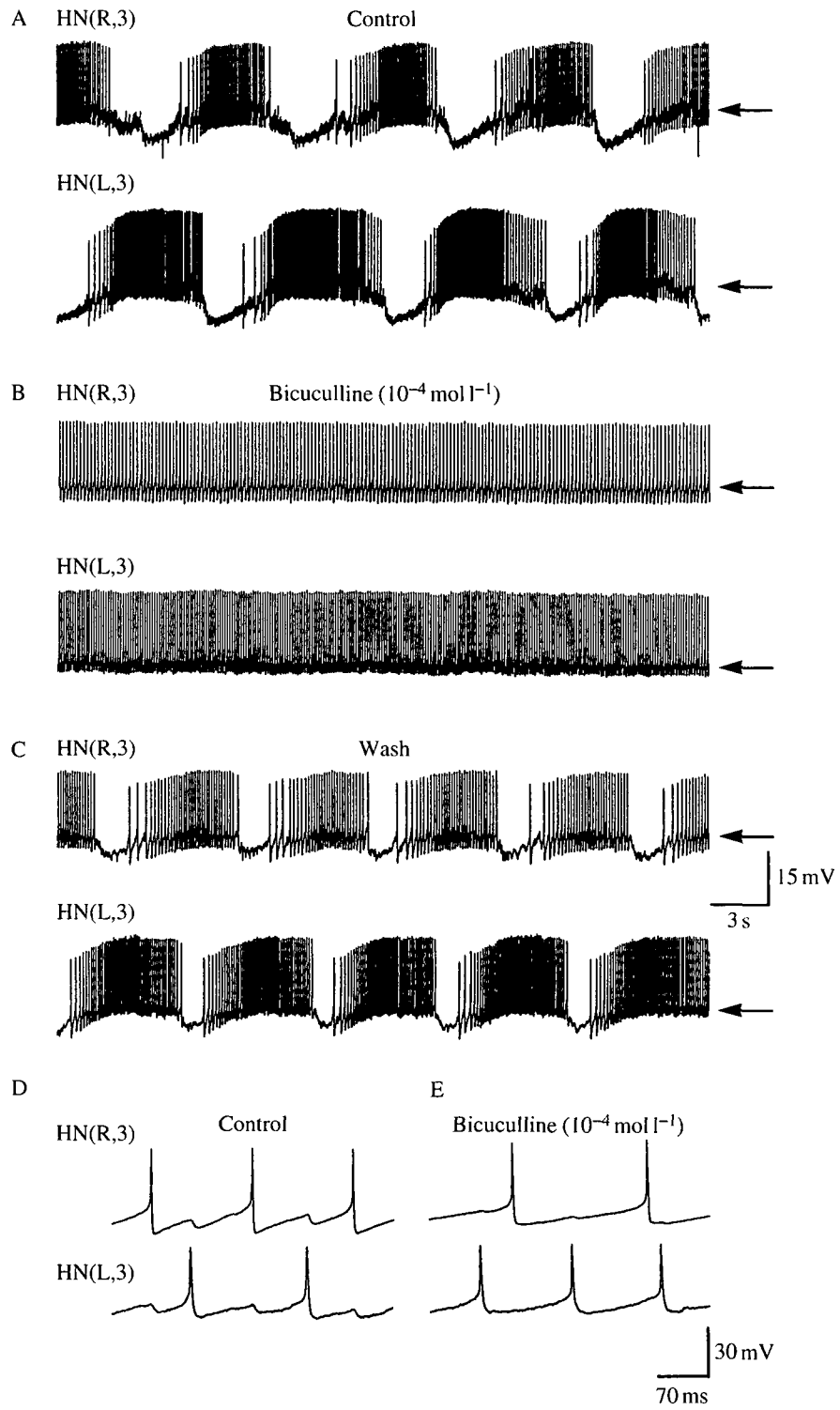

Fig. 2

Fig. 2. Bicuculline methiodide blocks synaptic transmission between HN cells. Normal alternating rhythmic activity in HN(3) cells (A) was disrupted when bicuculline methiodide ($10^{-4} \text{ mol l}^{-1}$) was added to the bath (B). The alternating rhythm appeared again after the ganglion had been washed with normal saline (C). Bicuculline methiodide reduced the size of spike-mediated IPSPs in HN cells (D,E). Arrows indicate a membrane potential of approximately -40 mV .

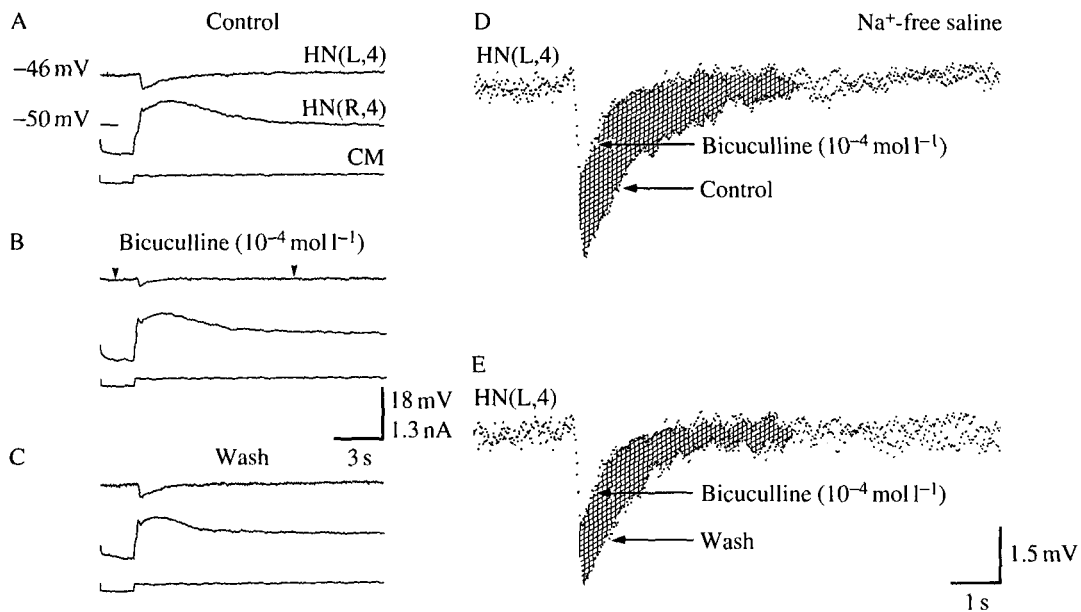

Fig. 3. Bicuculline methiodide blocks graded transmission between HN cells. The ganglion was bathed in Na^+ -free saline to block spikes. (A) IPSPs in HN(L,4) were elicited by plateau potentials generated in HN(R,4) by injection of negative current (CM, current monitor). (B) The IPSP amplitude was reduced when bicuculline methiodide ($10^{-4} \text{ mol l}^{-1}$) was added to the bath. (C) The IPSP amplitude was restored after the ganglion had been washed. Each trace is an average of three sweeps. (D) For better comparison of IPSP amplitude, the IPSP of the control recording (A) and the IPSP recorded in bicuculline (B) were enlarged and superimposed. The enlarged part of the recording is marked by arrowheads in (B). The difference in size is indicated by the hatched area. (E) Superimposed recordings of the IPSP in bicuculline (B) and the IPSP after washing (C) to show the reversibility of the bicuculline block.

rule out indirect effects. At least three experiments were carried out with each substance. In none of the experiments was a substance-induced alteration of the membrane potential detected.

Acetylcholine (ACh) is not only a well-known excitatory transmitter but also an inhibitory transmitter, e.g. in some amphibians (Hartzell *et al.* 1977; David *et al.* 1992) and in some molluscs (Tauc and Gerschenfeld, 1962; Neild and Thomas, 1974; Kehoe 1972*a,b*). In the leech, excitatory effects of ACh are known. HE cells are probably cholinergic (Calabrese and Maranto, 1986) and the excitatory motor

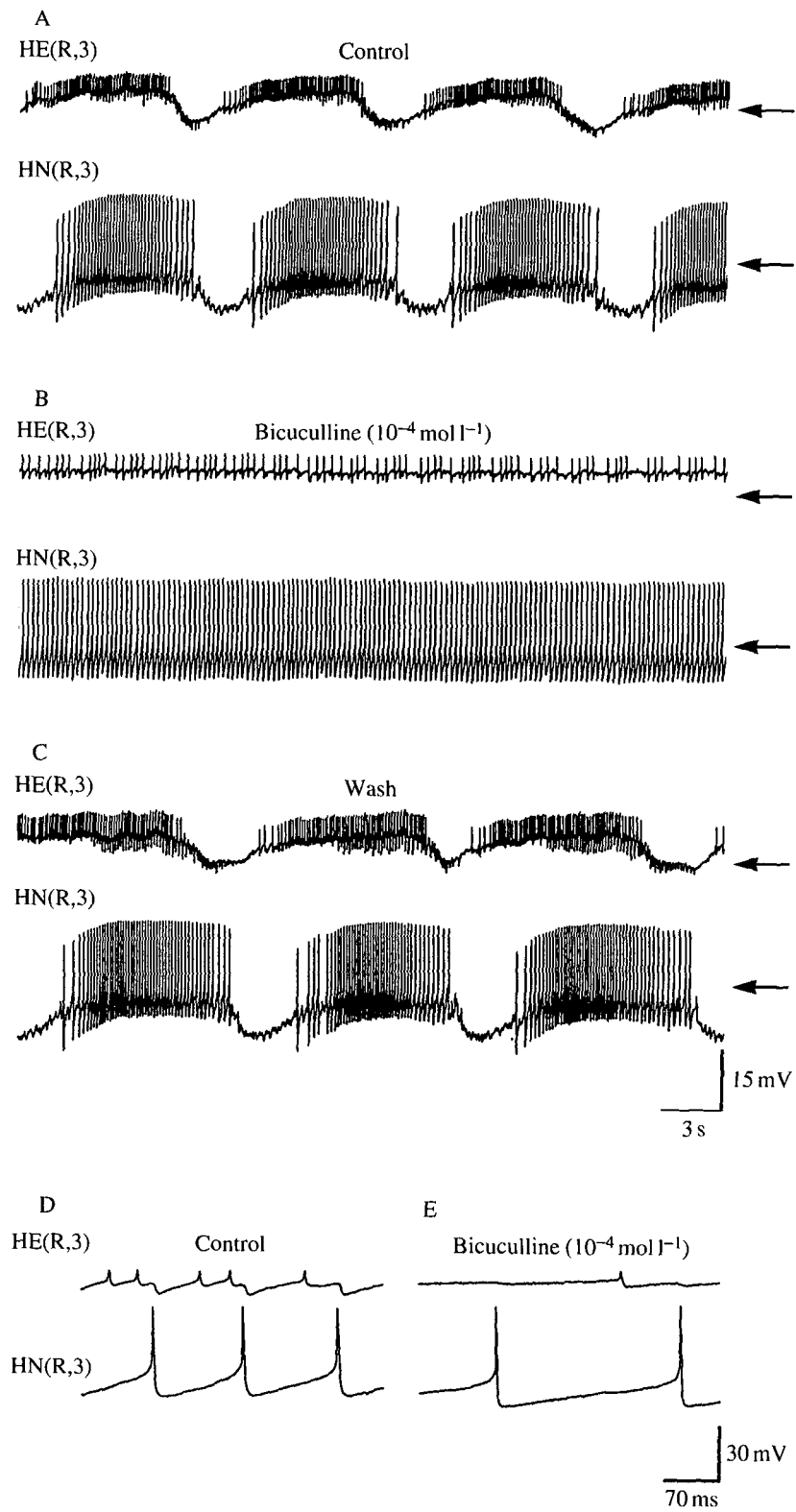

Fig. 4

Fig. 4. Bicuculline methiodide blocks synaptic transmission between HN and HE cells. Normal rhythmic activity in an HN(3) cell and the ipsilateral HE(3) cell (A) was disrupted when bicuculline methiodide ($10^{-4} \text{ mol l}^{-1}$) was added to the bath (B). The normal rhythm reappeared after the ganglion had been washed with normal saline (C). Under control conditions, spikes in the HN cell elicited IPSPs in the HE cell (D). Bicuculline methiodide reduced the size of IPSPs in the HE cell (E). Arrows indicate a membrane potential of approximately -40 mV .

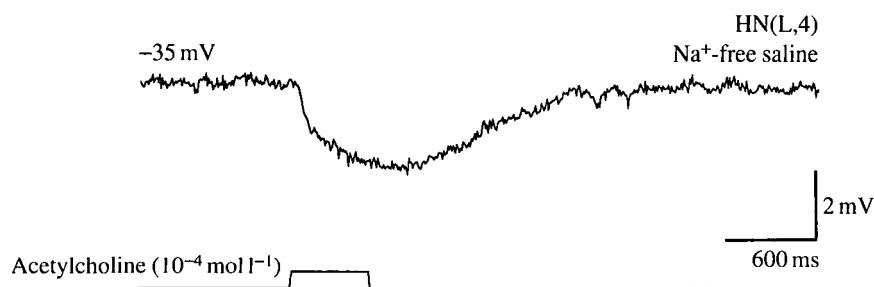

Fig. 5. Acetylcholine (ACh) hyperpolarizes an HN(3) cell. An IPSP-like response was elicited in an HN(4) cell (upper trace) by focal application of ACh ($10^{-4} \text{ mol l}^{-1}$; lower trace) onto the soma. The membrane potential of the cell was held at -35 mV . Na^+ -free saline was used for superfusion.

neurons of the longitudinal muscles use ACh as a transmitter (Kuffler, 1978; Sargent, 1977). Some leech neurons show excitatory responses when ACh is applied onto the soma (Sargent *et al.* 1977). A few other neurons may be depolarized at some receptors and hyperpolarized at others (Sargent *et al.* 1977).

To test ACh as a putative transmitter of HN cells ACh ($10^{-4} \text{ mol l}^{-1}$ in saline) was applied focally onto their somata (Fig. 5). Recordings were made from the HN(4) cell while the ganglion was bathed in Na^+ -free saline to suppress spikes and to obtain a stable membrane potential. A pulse (500 ms) of ACh elicited an IPSP-like hyperpolarization while the membrane potential was held at -35 mV .

This hyperpolarizing response of the HN cells is not restricted to local activation of receptors on the somata. In another set of experiments, recordings were made from HN cells while the ganglion was superfused with saline containing the synthetic ACh agonist carbachol (the advantage of carbachol is that it is not metabolized like ACh). An example is shown in Fig. 6. During superfusion of the ganglion with Na^+ - and Ca^{2+} -free saline, which blocks chemical synaptic transmission, the membrane potential settled at -45 mV . *Via* current injection into the cell the membrane potential was held at -35 mV (DCC) and superfusion with saline containing carbachol ($10^{-3} \text{ mol l}^{-1}$) was started. Superfusion with carbachol caused hyperpolarization of the cell. After 5 min of superfusion, the potential settled at -47 mV . The original holding potential was restored by washing the ganglion for 30 min with carbachol-free saline.

The hyperpolarizing effect of carbachol could also be shown by focal application

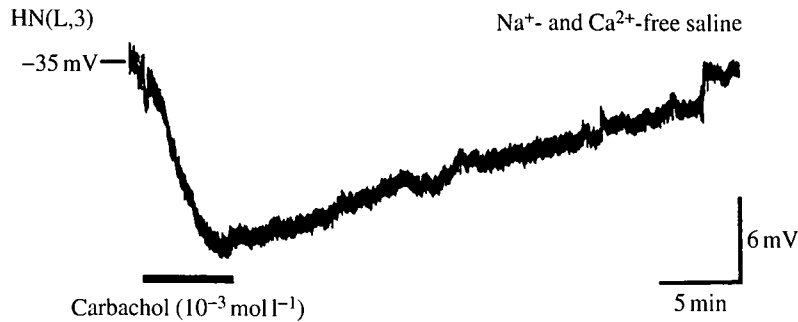

Fig. 6. An HN(3) cell hyperpolarized during bath application of the ACh agonist carbachol ($10^{-3} \text{ mol l}^{-1}$). The membrane potential settled at -47 mV after 5 min of carbachol application. Na^{+} - and Ca^{2+} -free saline was used for superfusion. The membrane potential of the cell was held at -35 mV .

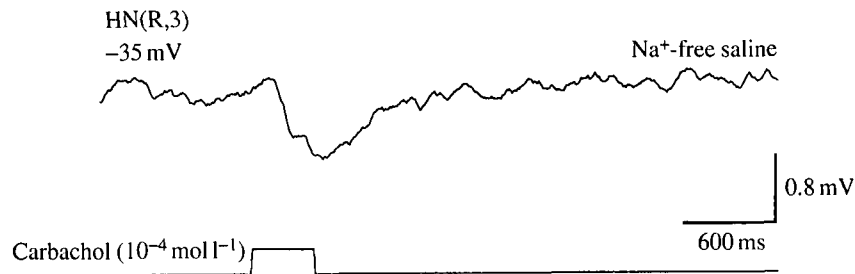

Fig. 7. An IPSP-like response was elicited in an HN(3) cell (upper trace) by focal application of carbachol ($10^{-4} \text{ mol l}^{-1}$; lower trace) into the neuropil. The ganglion was bathed in Na^{+} -free saline. The membrane potential of the cell was held at -35 mV . The upper trace was low-pass filtered (cut-off 33 Hz).

of carbachol into the neuropil. During all experiments where carbachol was applied focally Na^{+} -free saline was used. Short pulses of carbachol led to IPSP-like hyperpolarizations of HN(3) cells ($N=2$, Fig. 7) and an HE(3) cell ($N=1$). Although it was difficult to find spots in the neuropil where responses of HN cells and HE cells could be elicited, focal application of carbachol onto the somata of HN and HE cells led to regular IPSP-like responses (Fig. 8). The elicited hyperpolarizations were greatly reduced when bicuculline methiodide ($10^{-4} \text{ mol l}^{-1}$) was added to the bath (Fig. 8). The effect was reversible, as shown by the restored response after washing.

The ability of the ACh agonist carbachol to hyperpolarize HN and HE cells is a further indication that ACh is the inhibitory transmitter used by HN cells. The observation that both IPSPs due to a postsynaptic HN cell and IPSP-like responses elicited by focal application of carbachol are blocked by the same drug indicates that extrasynaptic and synaptic receptors share a common pharmacology and supports the suggestion that ACh is the transmitter of HN cells.

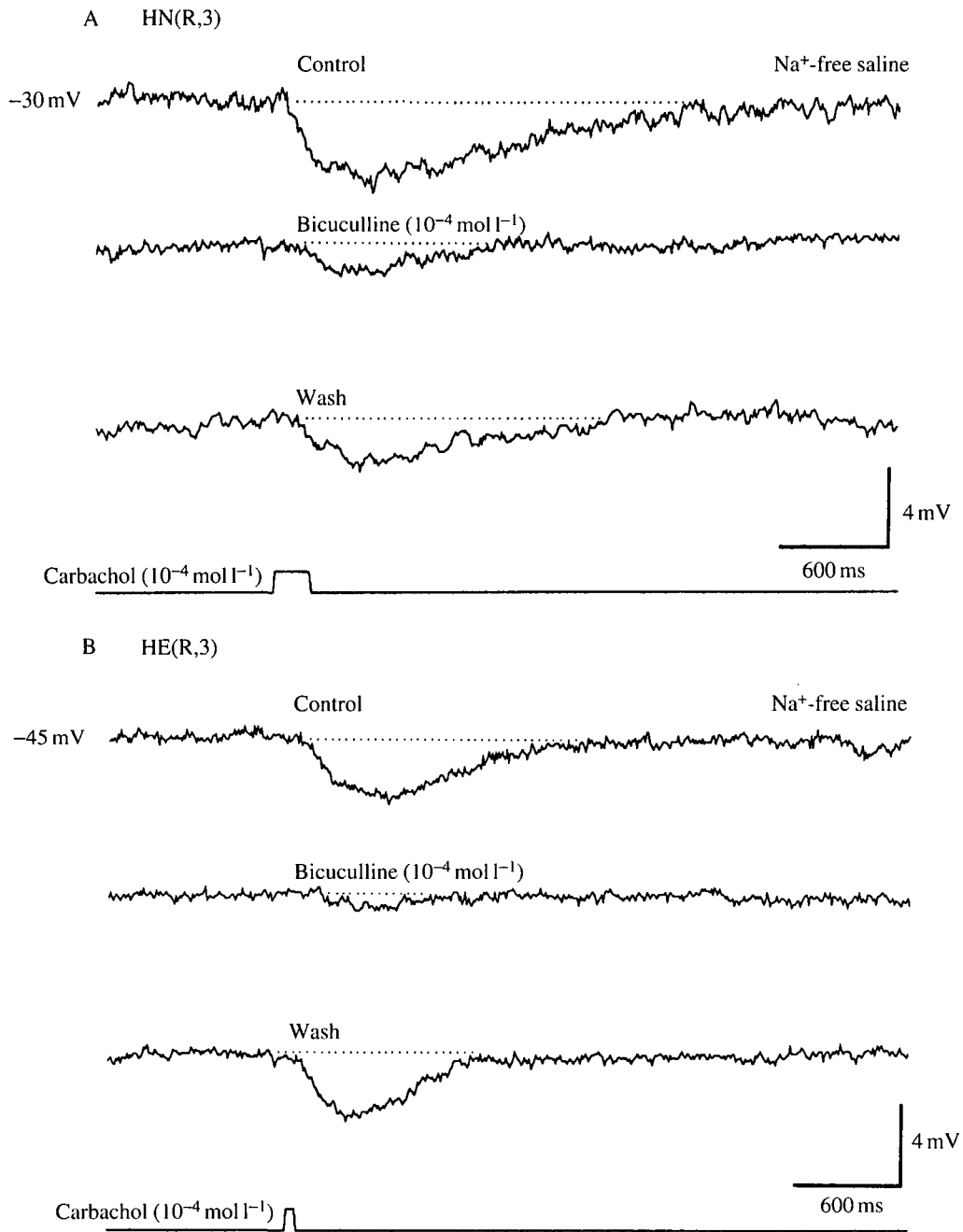

Fig. 8. IPSP-like responses were elicited in an HN(3) interneuron (A) and an HE(3) motor neuron (B) by focal application of carbachol (10^{-4} mol l⁻¹) to their somata (top trace). The hyperpolarizations were reduced when bicuculline methiodide (10^{-4} mol l⁻¹) was added to the bathing solution (second trace). The block was reversible, as shown by the restored responses after washing (third trace). The ganglia were bathed in Na⁺-free saline. The HN cell was held at a potential of -30 mV; the HE cell was held at a potential of -45 mV (indicated by dashed lines).

It has not been possible to classify the ACh receptor as nicotinic or muscarinic. Different drugs were added to a superfusate containing carbachol ($10^{-4} \text{ mol l}^{-1}$). Neither the muscarinic receptor blocker atropine ($10^{-4} \text{ mol l}^{-1}$) nor the nicotinic receptor blocker *d*-tubocurarine ($10^{-4} \text{ mol l}^{-1}$) was able to prevent hyperpolarization of HN cells by carbachol. The resting potential of HN cells of ganglia bathed in Na^+ -free saline was not influenced by the muscarinic agonists acetyl-beta-metacholine ($10^{-4} \text{ mol l}^{-1}$) or pilocarpine ($10^{-4} \text{ mol l}^{-1}$; Crossland, 1980).

Some experiments were carried out in which HN cell activity was recorded in normal saline containing the choline esterase blockers eserine or neostigmine at concentrations from 10^{-4} to $10^{-6} \text{ mol l}^{-1}$. Concentrations of $10^{-4} \text{ mol l}^{-1}$ caused what appeared to be nonspecific effects, e.g. irregular bursting pattern. Eserine seemed not to affect inhibition of HN cells at lower concentrations. Neostigmine ($10^{-5} \text{ mol l}^{-1}$) seemed to have a mild hyperpolarizing effect, around -5 mV , on HN and HE cells (observed in two of three experiments). This effect, which was presumably due to longer-lasting ACh action, could not be confirmed in experiments where IPSPs in an HN neuron were elicited by depolarization of the contralateral HN cell in Na^+ -free saline. The ACh receptor blocker α -bungarotoxin ($10^{-7} \text{ mol l}^{-1}$ in normal saline) did not block synaptic transmission between HN cells after 30 min of superfusion.

Are hyperpolarizing responses of HN cells to carbachol chloride-mediated?

IPSPs in HE cells and HN cells reversed when Cl^- was injected into the cells because the driving force for Cl^- was reversed (Nicholls and Wallace, 1978). The conclusion from these results was that IPSPs arise, at least in part, from an increased Cl^- conductance. This was confirmed in experiments where IPSPs were abolished when the ganglia were superfused with saline with low Cl^- concentrations (Calabrese, 1979).

Tests were performed to determine whether the hyperpolarizing response to carbachol was mediated by an increased Cl^- conductance. An increased membrane conductance, caused by focal application of carbachol onto the soma of an HE cell, is shown in Fig. 9. Pulses (90 ms) of negative current with constant amplitude were injected into an HE cell and caused corresponding hyperpolarizations of the membrane potential of the cell. The amplitudes of these hyperpolarizations were clearly smaller during an IPSP-like response than at the holding potential of -35 mV , demonstrating a conductance increase due to carbachol application. Similar results were obtained for HN cells. A role for Cl^- in mediating the response to carbachol was shown in experiments where Cl^- was injected ionophoretically into HE or HN cells using recording electrodes filled with 3 mol l^{-1} KCl while carbachol was focally applied onto the somata. Fig. 10 shows an IPSP-like potential elicited prior to Cl^- injection in an HE cell. After Cl^- injection this potential was reversed. Similar results were obtained for HN cells. These findings taken together indicate that the hyperpolarizing responses elicited by carbachol arise from an increased Cl^- conductance, just like IPSPs in HE or HN cells.

IPSPs in HN cells and HE cells have reversal potentials expected for Cl^- -mediated potentials. IPSPs of HN cells reverse at membrane potentials of approximately -60 mV (Angstadt and Calabrese, 1991) and IPSPs of HE cells reverse at membrane potentials of approximately -70 mV (Nicholls and Wallace, 1978). If the generation of IPSP-like responses elicited by carbachol at the somata of HN and HE cells is based on the same mechanisms as the generation of IPSPs in the neuropil, then the IPSP-like responses should have a similar reversal potential to IPSPs.

To test this hypothesis, the reversal potential of IPSP-like responses in HN cells

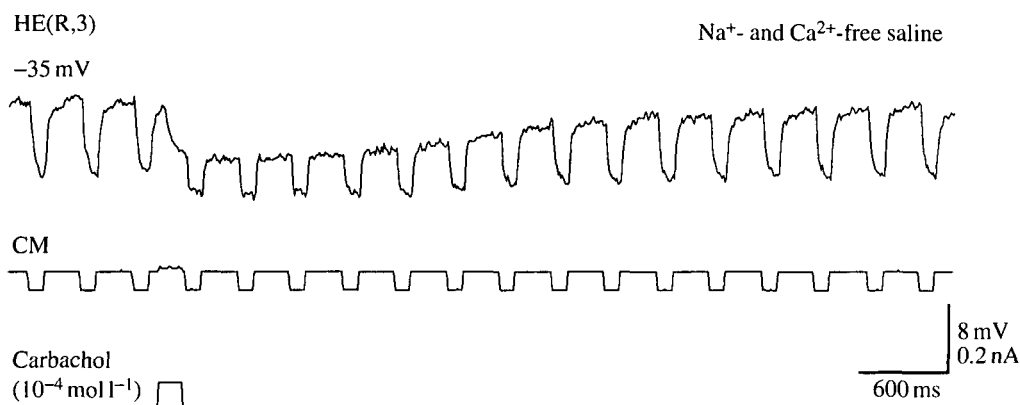

Fig. 9. Pulses of negative current (CM, current monitor) with constant amplitude were injected into an HE cell (upper trace) and caused corresponding hyperpolarizations of the membrane potential of the cell. The amplitudes of these hyperpolarizations decreased during an IPSP-like response elicited by focal application of carbachol (10^{-4} mol l⁻¹; lower trace) onto the soma of the cell. The ganglion were bathed in Na⁺- and Ca²⁺-free saline.

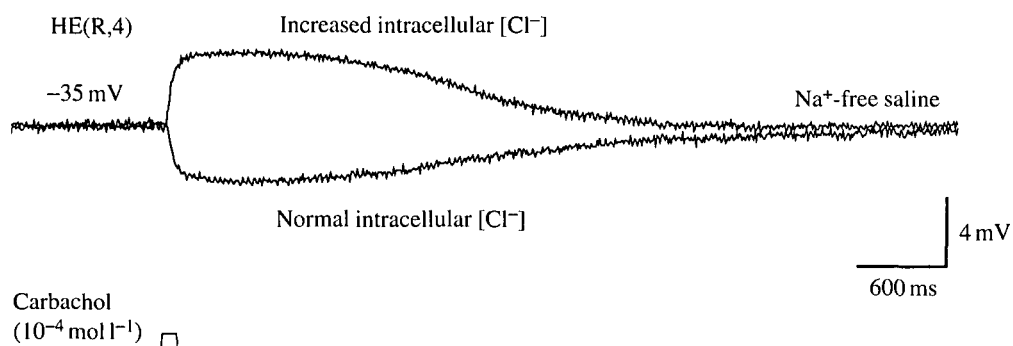

Fig. 10. An IPSP-like response in an HE(4) motor neuron elicited by focal application of carbachol (10^{-4} mol l⁻¹) to its soma was reversed after Cl^- had been injected into the cell. A recording of a normal IPSP-like response is laid over a recording of a reversed response. The ganglion was bathed in Na⁺-free saline. The membrane potential of the cell was held at -35 mV and remained constant after Cl^- injection.

and HE cells was determined. To do this, carbachol was applied focally onto the somata while the cells were held at different membrane potentials, starting at -25 mV and stepping down in 10 mV steps to -65 mV, or more negative values if necessary. Usually two ejections of carbachol were performed at each holding potential. Ganglia were superfused with Na^+ -free saline.

The reversal potential in HN cells was -41.5 ± 4.1 mV (mean \pm s.d., $N=8$; Fig. 11A). (In one case where ACh instead of carbachol was applied onto the soma of an HN cell the reversal potential was -45 mV.) In HE cells, the reversal potential was -53 ± 11.8 mV (mean \pm s.d., $N=12$; Fig. 11B).

The mean reversal potentials of IPSP-like responses in the somata of HN and HE cells obtained in this study are almost 20 mV more positive than the reversal potential of IPSPs in these cells. The discrepancy between reversal potentials of IPSP-like responses elicited by focal application of carbachol onto the soma and reversal potentials of IPSPs due to a presynaptic HN cell can be demonstrated in the same HN cell. IPSPs were elicited by evoked plateau potentials in a presynaptic HN cell. These IPSPs reversed at around -60 mV. In the same HN cell, IPSP-like responses elicited by focal application of carbachol onto the soma reversed at around -40 mV. The activation of a contaminating depolarizing inward cation current by carbachol could explain the more positive reversal potential. The amplitude of a depolarization due to a cation-mediated inward current would be increased by stepping to more negative holding potentials. Such a current would counteract the hyperpolarizing Cl^- -mediated current. Therefore, it would lead to the recording of a more positive reversal potential than would be expected for a pure Cl^- current.

In the first set of reversal experiments ganglia were superfused with Na^+ -free saline. Therefore, only Ca^{2+} could mediate a depolarizing current. To test whether a Ca^{2+} current, contaminating the Cl^- -mediated response, was activated by carbachol, experiments were carried out in Na^+ - and Ca^{2+} -free saline. In these experiments, the reversal potential of IPSP-like responses elicited by focal application of carbachol onto the somata of HN cells was 44.8 ± 5.9 mV (mean \pm s.d., $N=5$).

The mean value of reversal potentials of IPSP-like responses measured in experiments where Ca^{2+} -free saline was used is not significantly different from the mean value measured in experiments where Ca^{2+} -containing saline was used (Student's t -test, $t_{0.1}$). Thus, a contribution of Ca^{2+} to the generation of potentials elicited by carbachol application onto the somata of HN cells can be ruled out. An alternative explanation for the discrepancy between reversal potentials elicited by focal application of carbachol onto the somata of HN and HE cells and IPSPs in the cells might be that the intracellular Cl^- concentration is distributed unevenly through the cells.

Fig. 11. Reversal potentials of IPSP-like responses in an HN and HE cell. Carbachol (10^{-4} mol l $^{-1}$) was focally applied onto the somata of an HN(3) cell (A) and an HE(3) cell (B). Traces show responses at different holding potentials (indicated to the left of the records). Each trace is an average of two sweeps.

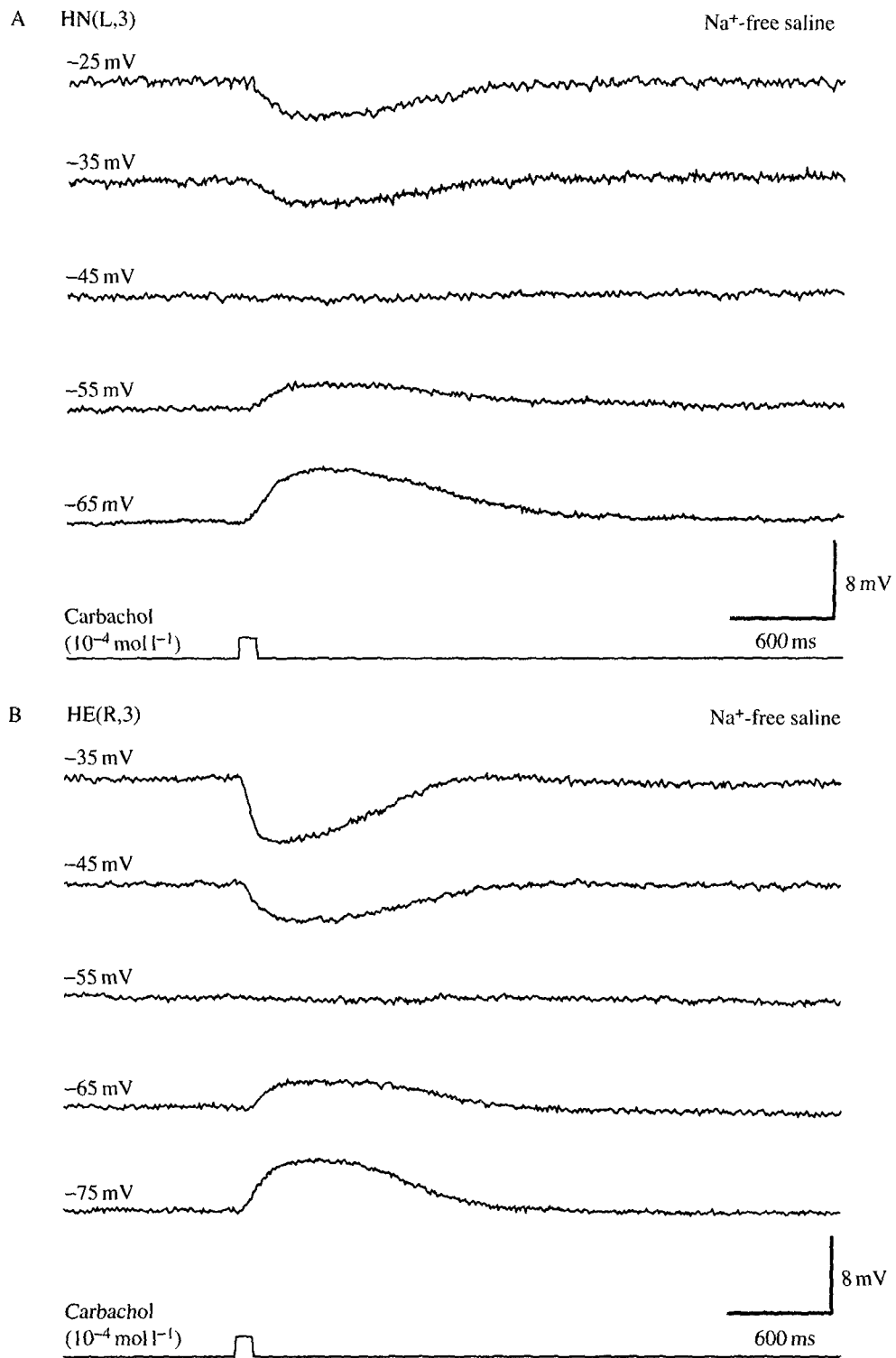

Fig. 11

Discussion

Acetylcholine as an inhibitory transmitter

Focal application of acetylcholine (ACh) or its agonist carbachol onto the somata in HN and HE cells leads to IPSP-like responses in the cells. Bath application of carbachol also hyperpolarizes these cells. Since ACh and carbachol both induce hyperpolarizations in Ca^{2+} -free Co^{2+} -containing saline, which should block chemical synaptic transmission, indirect effects through intermediate neurons can be ruled out. Pharmacological tests of GABA as a potential transmitter of HN cells failed. This negative result for GABA is supported by the observation that HN neurons appear not to have a GABA uptake system (Cline, 1983). Pharmacological tests of glycine, glutamate and some biogenic amines as transmitters were also negative. Serotonin- and dopamine-containing cells in the leech CNS have been mapped using fluorescence techniques and other methods (for a review, see Lent and Adams, 1989), and HN cells are not among them. Responses evoked in HN cells and HE cells by focal application of the ACh agonist carbachol and the normal transmission between HN cells and HN and HE cells are both blocked by bicuculline methiodide. This substance is known to block ACh responses in other systems (see below). Taking all these data together, it seems probable that, despite the observation that acetylcholine esterase blockers and α -bungarotoxin did not affect synaptic transmission between HN cells, ACh is the inhibitory transmitter of HN cells.

Neuronal inhibition by ACh release has been demonstrated both in vertebrates and in invertebrates. Vagally released ACh elicits IPSPs at certain receptors of cardiac pacemaker cells in amphibians (Hartzell *et al.* 1977; David *et al.* 1992) and, in invertebrates, inhibitory actions of ACh have been studied in detail in the molluscs *Helix aspersa* (Tauc and Gerschenfeld, 1962; Neild and Thomas, 1974) and *Aplysia californica* (Kehoe 1972a,b).

ACh has not been demonstrated to be an inhibitory transmitter in the leech; however, some leech neurons respond to ACh application onto their somata. French *et al.* (1990) have shown that ACh, focally applied onto the somata of Retzius cells of the fifth and the sixth ganglia, causes hyperpolarizing responses in these cells. Cholinergic neurons presynaptic to Retzius cells have not been identified. Sargent *et al.* (1977) have shown that focal application of ACh onto the somata of L cells elicits hyperpolarizations, but also causes depolarizations. For the N cell input to the L cell they could show a pharmacological difference between extrasynaptic somatic and synaptic responses, which led to the conclusion either that the N-cell-to-L-cell synapse is not cholinergic or that extrasynaptic and synaptic ACh receptors have profound pharmacological differences.

For HN and HE cells, extrasynaptic receptors on the soma and synaptic receptors appear to be similar. Both IPSPs in HN cells and HE cells elicited by a presynaptic HN cell and IPSP-like hyperpolarizations elicited by focal application of carbachol onto the somata of HN cells and HE cells are effectively blocked by bicuculline methiodide. This result indicates that extrasynaptic and synaptic receptors share a common pharmacology, as also demonstrated for GABA

receptors on somata and neurites of inhibitory motor neurons of the longitudinal muscles, cell 1 and cell 2 (Cline, 1986).

Bicuculline methiodide as an acetylcholine antagonist

Bicuculline methiodide is known to be an effective GABA antagonist (Pong and Graham, 1972). Therefore, it is interesting to find that bicuculline methiodide blocks ACh-mediated synaptic transmission. This effect of bicuculline methiodide is not uncommon, however, since it blocks depolarizing responses to acetylcholine in isolated neuronal somata of the locust (Benson, 1988) and it blocks ACh-elicited depolarizing responses in motor neurons of *Manduca sexta* (B. Waldrop, personal communication). Bicuculline methiodide has no effects on GABA responses of locust neuronal somata (Benson, 1988) and little or no effect on GABA responses of certain neurons in the CNS of *Periplaneta americana* (Sattelle, 1990) and *Manduca sexta* (B. Waldrop, personal communication). In contrast, in the leech, bicuculline methiodide blocks hyperpolarizing responses elicited by focal application of GABA onto the somata of motor neurons of the longitudinal muscles and blocks the inhibitory effects of these probably GABAergic neurons on postsynaptic targets (Cline, 1986).

In R2 neurons of *Aplysia*, bicuculline chloride and picrotoxin block hyperpolarizing responses to focal application of ACh and GABA onto the somata (Yarowsky and Carpenter, 1978). In the leech, picrotoxin has no effect on transmission between HN neurons since bath application of picrotoxin (10^{-4} mol l⁻¹) did not disturb the normal bursting pattern or diminish IPSPs.

Acetylcholine increases Cl⁻ conductance in HN and HE cells

Hyperpolarizations of neurons elicited by ACh application may be caused by an increased K⁺ conductance (Hartzell *et al.* 1977; Kehoe 1972a) or may result from an increased Cl⁻ conductance (Kehoe, 1972a; Neild and Thomas, 1974). In the leech, the IPSP-like responses elicited by carbachol in HE and HN cells are accompanied by a conductance increase and are reversed when Cl⁻ is injected into the cells to reverse the driving force for Cl⁻. Thus, the hyperpolarizing response due to ACh or carbachol application seems to depend on an increased Cl⁻ conductance. The same dependence is observed for IPSPs elicited by HN cell spikes. IPSPs in HN and HE cells reverse when Cl⁻ is injected into the cells and do not depend on external K⁺ (Nicholls and Wallace, 1978), and IPSPs in HN and HE cells disappear in low-Cl⁻ (4 mmol l⁻¹) saline (Calabrese, 1979). The correspondence of Cl⁻-dependence for IPSPs and IPSP-like responses elicited by carbachol is a further indication that IPSPs in HN and HE cells are generated upon ACh release by presynaptic HN cells.

This conclusion seems to be challenged by the observation that the reversal potentials of IPSP-like responses elicited in the somata of HN and HE cells are more positive than the reversal potentials of IPSPs elicited by a postsynaptic HN cell at synapses on neurites. The more positive reversal potentials are not due to contaminating depolarizing Na⁺ or Ca²⁺ currents that might have been activated

by carbachol, since all reversal potentials were measured in Na^+ -free saline and reversal potentials do not differ when Ca^{2+} is replaced by Co^{2+} .

It seems unlikely that an electrically distant site of origin for IPSPs is the explanation for the discrepancy between the reversal potentials of IPSPs and the soma responses induced by carbachol. During normal activity, HN cells are hyperpolarized to -55 mV by IPSPs between bursts of action potentials as measured in the soma (e.g. Fig. 2). These IPSPs are generated in the neuropil and should be reduced when arriving in the soma. Therefore, the IPSPs should be more negative than -55 mV in the neuropil. These considerations lead us to the conclusion that the reversal potential of IPSPs in the neuropil of HN cells is at least -55 mV . The same arguments hold for HE cells. Cl^- may, therefore, not be distributed evenly in the cells, i.e. the Cl^- concentration in the neurites of HN and HE cells may be lower than in their somata.

We thank Drs Siglinde Gramoll, Ted W. Simon and Clifford A. Opdyke for helpful suggestions and stimulating discussion. This work was supported by NIH Grant NS24072.

References

- ANGSTADT, J. D. AND CALABRESE, R. L. (1991). Calcium currents and graded synaptic transmission between heart interneurons of the leech. *J. Neurosci.* **11**, 746–759.
- ARBAS, E. A. AND CALABRESE, R. L. (1987). Ionic conductances underlying the activity of interneurons that control heartbeat in the medicinal leech. *J. Neurosci.* **7**, 3945–3952.
- BENSON, J. A. (1988). Bicuculline blocks the response to acetylcholine and nicotine but not muscarine or GABA in isolated insect neuronal somata. *Brain Res.* **458**, 65–71.
- CALABRESE, R. L. (1977). The neural control of alternate heartbeat coordination states in the leech, *Hirudo medicinalis*. *J. comp. Physiol.* **122**, 111–143.
- CALABRESE, R. L. (1979). The role of endogenous membrane properties and synaptic interaction in generating the heartbeat rhythm of the leech, *Hirudo medicinalis*. *J. exp. Biol.* **82**, 163–176.
- CALABRESE, R. L., ANGSTADT, J. D. AND ARBAS, E. A. (1989). A neural oscillator based on reciprocal inhibition. In *Perspectives in Neural Systems and Behavior* (ed. T. J. Carew, D. Kelly), pp. 33–50. New York: Liss.
- CALABRESE, R. L. AND MARANTO, A. R. (1986). Cholinergic action on the heart of the leech, *Hirudo medicinalis*. *J. exp. Biol.* **125**, 205–224.
- CLINE, H. T. (1983). ^3H -GABA uptake selectively labels identifiable neurons in the leech central nervous system. *J. comp. Neurol.* **215**, 351–358.
- CLINE, H. T. (1986). Physiological evidence for GABA as a neurotransmitter in the leech. *J. Neurosci.* **6**, 2848–2856.
- CROSSLAND, J. (1980). *Lewis's Pharmacology*. 5th edition. Edinburgh, London, Melbourne, New York: Churchill Livingstone.
- DAVID, G., HIRST, S., BRAMICH, N. J., EDWARDS, F. R. AND KLEMM, M. (1992). Transmission at autonomic neuroeffector junctions. *Trends Neurosci.* **2**, 40–46.
- FRENCH, K. A., REYNOLDS, S. A., HARTLEY, M., HEINEMANN, S. AND KRISTAN, W. B. (1990). Multiple acetylcholine receptor genes are expressed in a tissue-specific fashion in the leech, *Hirudo medicinalis*. *Soc. Neurosci. Abstr.* **20**, 404.
- HARTZELL, H. C., KUFFLER, S. W., STICKGOLD, R. AND YOSHIKAMI, D. (1977). Synaptic excitation and inhibition resulting from direct action of acetylcholine on two types of chemoreceptors on individual amphibian parasympathetic neurones. *J. Physiol., Lond.* **271**, 817–846.
- KEHOE, J. (1972a). Ionic mechanisms of a two-component cholinergic inhibition in *Aplysia* neurones. *J. Physiol., Lond.* **225**, 84–114.

- KEHOE, J. (1972*b*). Three acetylcholine receptors in *Aplysia* neurones. *J. Physiol., Lond.* **225**, 115–146.
- KUFFLER, D. (1978). Neuromuscular transmission in longitudinal muscle of the leech *Hirudo medicinalis*. *J. comp. Physiol.* **124**, 333–338.
- LENT, C. M. AND ADAMS, S. L. (1989). Leeches: Annelids of medical and scientific utility. In *Nonmammalian Animal Models for Biomedical Research* (ed. A. D. Woodhead), pp. 21–46. Boca Raton, Florida: CRC Press, Inc.
- MARANTO, A. R. AND CALABRESE, R. L. (1984). Neurol control of the hearts in the leech, *Hirudo medicinalis*. II. Myogenic activity and its control by heart motor neurons. *J. comp. Physiol. A* **154**, 381–391.
- NEILD, T. O. AND THOMAS, R. C. (1974). Intracellular chloride activity and the effects of acetylcholine in snail neurones. *J. Physiol., Lond.* **242**, 453–470.
- NICHOLLS, J. G. AND BAYLOR, D. A. (1968). Specific modalities and receptive fields of sensory neurons in the CNS of the leech. *J. Neurophysiol.* **31**, 740–756.
- NICHOLLS, J. G. AND WALLACE, B. G. (1978). Modulation of transmission at an inhibitory synapse in the central nervous system of the leech. *J. Physiol., Lond.* **281**, 157–170.
- PETERSON, E. L. (1983). Generation and coordination of heartbeat timing oscillation in the medicinal leech. II. Intersegmental coordination. *J. Neurophysiol.* **49**, 627–638.
- PETERSON, E. L. AND CALABRESE, R. L. (1982). Dynamic analysis of a rhythmic neural circuit in the leech, *Hirudo medicinalis*. *J. Neurophysiol.* **47**, 256–271.
- PONG, S. F. AND GRAHAM, L. T. (1972). *N*-Methyl bicuculline, a convulsant more potent than bicuculline. *Brain Res.* **42**, 486–490.
- SARGENT, P. B. (1977). Synthesis of acetylcholine by excitatory motoneurons in the central nervous system of the leech. *J. Neurophysiol.* **40**, 453–460.
- SARGENT, P. B., YAU, K.-W. AND NICHOLLS, J. G. (1977). Extrasynaptic receptors on cell bodies of neurons in central nervous system of the leech. *J. Neurophysiol.* **40**, 446–452.
- SATTELLE, D. B. (1990). GABA receptors of insects. *Adv. Insect Physiol.* **22**, 1–113.
- TAUC, L. AND GERSCHENFELD, H. M. (1962). A cholinergic mechanism of inhibitory synaptic transmission in a mollusc nervous system. *J. Neurophysiol.* **25**, 236–262.
- THOMPSON, W. J. AND STENT, G. S. (1976*a*). Neural control of heartbeat in the medicinal leech. I. Generation of vascular constriction rhythm by heart motor neurons. *J. comp. Physiol.* **111**, 261–279.
- THOMPSON, W. J. AND STENT, G. S. (1976*b*). Neural control of heartbeat in the medicinal leech. II. Intersegmental coordination of heart motor neuron activity by heart interneurons. *J. comp. Physiol.* **111**, 281–307.
- THOMPSON, W. J. AND STENT, G. S. (1976*c*). Neural control of heartbeat in the medicinal leech. III. Synaptic relations of the heart interneurons. *J. comp. Physiol.* **111**, 309–333.
- TOLBERT, L. P. AND CALABRESE, R. L. (1985). Anatomical analysis of contacts between identified neurons that control heartbeat in the leech *Hirudo medicinalis*. *Cell Tissue Res.* **242**, 257–267.
- YAROWSKY, P. J. AND CARPENTER, D. O. (1978). A comparison of similar ionic responses to gamma-aminobutyric acid and acetylcholine. *J. Neurophysiol.* **41**, 531–541.