

## RESPIRATORY MUSCLE ACTIVITY IN RELATION TO VOCALIZATION IN FLYING BATS

WINSTON C. LANCASTER\*, O. W. HENSON, JR<sup>†</sup> AND A. W. KEATING

*Department of Cell Biology and Anatomy, University of North Carolina at Chapel Hill, Chapel Hill, NC 27599-7090, USA*

*Accepted 30 August 1994*

### Summary

The structure of the thoracic and abdominal walls of *Pteronotus parnellii* (Microchiroptera: Mormoopidae) was described with respect to their function in respiration and vocalization. We monitored electromyographic activity of respiratory and flight muscles in relation to echolocative vocalization. In flight, signals were telemetered with a small FM transmitter modified to summate the low-frequency myopotentials with biosonar signals from a ceramic-crystal microphone. Recordings were also made from the same bats confined to a small cage. Vocalizations were used as the parameter by which all muscle activities were correlated. A discrete burst of activity in the lateral abdominal wall muscles accompanied each vocalization. Diaphragmatic myopotentials occurred between groups of calls and did not coincide with activity of the abdominal wall or with vocalizations. Flight muscles were not active in resting bats. During flight, vocalizations and the

abdominal muscle activity that accompanied them coincided with myopotentials of the pectoralis and serratus ventralis muscles.

We propose that contractions of the lateral abdominal wall provide the primary power for the production of intense biosonar vocalization in flying and in stationary bats. In flight, synchronization of vocalization with activity of the pectoralis and serratus ventralis jointly contribute to the pressurization of the thoraco-abdominal cavity. This utilization of pressure that is normally generated in flight facilitates respiration and allows for the production of intense vocalizations with little additional energetic expenditure.

Key words: bats, echolocation, vocalization, respiration, electromyogram.

### Introduction

Research on bat echolocation has largely centered on the production of ultrasonic calls and on the reception and processing of echoes. The larynx, as the site of sound production, received attention from some of the earliest workers on bat morphology (Robin, 1881), but the means by which bats generate the pressure that powers vocalization has been largely neglected.

Sound production is not typically perceived as an energetically demanding activity and has received little attention in terms of measurements of metabolic costs. However, in a review of the literature on the energetics of acoustic signaling in frogs and insects, Ryan (1988) noted that oxygen consumption during calling is five- to 30-fold greater than oxygen consumption at rest. Marsh and Taigen (1987) found that the muscles used for calling (for mate attraction) in male gray tree frogs were significantly larger than in females and that the muscles had physiological adaptations to enhance aerobic capacity. Speakman *et al.* (1989) found that oxygen

consumption in stationary, echolocating pipistrelle bats averaged 9.5 times the basal metabolic rate. Despite limited data, it is reasonable to suggest that the production of intense sounds is, in general, an energetically demanding activity and one subject to morphological and physiological adaptation for the enhancement of efficiency.

Among terrestrial vertebrates, birds and mammals typically have a greater capacity for sustained aerobic activity than do reptiles and amphibians. This capacity is, in part, attributed to the ability of birds and mammals to ventilate their lungs efficiently while locomoting (Carrier, 1987). Entrainment of respiration to locomotion has been demonstrated in numerous species of birds (Berger *et al.* 1970) and mammals (Bramble and Carrier, 1983; Alexander, 1989; Bramble and Jenkins, 1993). Bats also synchronize respiration with wingbeat in a one-to-one relationship (Suthers *et al.* 1972; Carpenter, 1986). Since vocalization is related to movements of air, it is also tied to respiration (Suthers *et al.* 1972; Roberts, 1972) and to the

\*Present address: Department of Zoology, University of Aberdeen, Aberdeen AB9 2TN, Scotland.

<sup>†</sup>To whom reprint requests should be addressed.

activity of respiratory muscles (Marchal, 1988; Hartley, 1990; Jürgens and Schriever, 1991). Vocalization, therefore, can have an intrinsic relationship to locomotion. Since bats are the only mammals that both fly and echolocate, they must of necessity vocalize during locomotion and it has been proposed that bats can produce their echolocative vocalizations at little or no energetic cost above that required for flight alone (Speakman and Racey, 1991). Integration of their system of orientation with the energetic advantages of locomotor-respiratory coupling has probably contributed to the success of the Microchiroptera.

Previous studies on the production of biosonar signals have focused on the comparative morphology of the larynx (Griffiths, 1983), its function as a gating mechanism (Suthers and Fattu, 1973) and the role of subglottic pressure in relation to vocalization (Fattu and Suthers, 1981). Here, we present morphological and physiological data that illustrate how bats generate the pressure required for echolocative vocalization. On the basis of these data, we propose a mechanism by which bats capitalize on the energy expended for flight to power echolocative vocalization. We offer hypotheses to account for the differences in the energetic cost of echolocation between flying and resting bats and for the variation in the propensity of different species to vocalize at rest.

### Materials and methods

*Pteronotus parnellii parnellii* were used for these experiments. All were captured in Jamaica and maintained in captivity on a diet of mealworms (*Tenebrio* larvae) and vitamin supplements. Care was under the supervision of the Division of Laboratory Animal Medicine at the University of North Carolina School of Medicine. Animals were housed in an enclosure with adequate space for flight (300 cm × 210 cm × 170 cm). Body masses ranged from 11 to 12 g. Formalin-fixed and skeletonized specimens of *P. parnellii* were used for morphological studies, and specimens of *Lasiurus borealis* (Vespertilionidae) were examined for comparative purposes. Nomenclature for myology follows Nomina Anatomica Veterinaria (1983).

#### Morphology

Four *P. parnellii* were fixed in 10% neutral, buffered formalin. Morphological details that could not be studied in gross dissection were examined in histological section. Tissues from fixed specimens were dehydrated in a graded series of alcohols and embedded in purified glycol-methacrylate plastic. Sections 4 µm in thickness were cut with a microtome and stained with Toluidine Blue. Three skeletonized specimens were examined.

#### Electromyography

Nine bats were used for electromyographic recordings. Electromyograms were recorded from the lateral abdominal wall (six bats), rectus abdominis (two bats), diaphragm (pars costalis) (two bats), pectoralis (one bat) and serratus ventralis

(one bat) in conjunction with echolocative vocalizations. Recordings from the lateral abdominal wall were not selective of specific muscle layers. Owing to its thinness and the orientation of its fascicles (see Results), the obliquus externus abdominis is not considered to be a major contributor to the recorded signals. The combined activities of the obliquus internus and transversus abdominis are considered to constitute the majority of the signal. Electromyographic techniques were primarily adapted from Loeb and Gans (1986) and Hermanson and Altenbach (1981, 1983, 1985).

#### Electrodes

Recordings from the abdominal muscles and diaphragm were made with patch electrodes designed for thin, sheet-like muscles. These electrodes were made from patches of Silastic sheeting (Dow Corning 501-1) measuring 6 mm × 6 mm. Insulated, silver bipolar electrode leads (76 µm, A-M Systems, Inc., Everett, Washington) were threaded through perforations in the patch such that the two wires lay parallel on the same side of the patch, separated by an interelectrode distance of approximately 2 mm. A length of insulation was removed equal to the interelectrode spacing. On the opposite side of the patch, leads were secured with silicone adhesive (Dow Corning 734). Two alternative methods were used to confirm the results of the patch electrodes for abdominal wall recordings. First, a bipolar electrode was constructed with similar dimensions and configuration to the patch electrode, but without the patch. The electrode was secured to the surface of the muscle with four 7-0 synthetic sutures (Dexon; Davis and Geck). This was covered with a 5 mm × 5 mm silastic patch, which was also sutured to the muscle to isolate the electrode from movements of the overlying skin. As an alternative, a small, bipolar hook electrode (Loeb and Gans, 1986) with 0.5 mm bare areas separated by 0.5 mm was inserted into the muscles of the abdominal wall with a 27 gauge hypodermic needle. Alternative electrodes yielded recordings similar to patch electrodes, but patch electrodes provided better signal-to-noise ratio. Smaller patch electrodes were used to record from the diaphragm. Patches were approximately 4 mm × 4 mm with rounded corners and an interelectrode spacing of approximately 1.5 mm. Electrodes for the pectoralis and serratus ventralis were of the offset hook design with 0.5 mm bare areas separated by 0.5 mm (Loeb and Gans, 1986).

#### Surgery

Surgical procedures were in accordance with established animal care guidelines. Under general anesthesia (Methoxyflurane), patch electrodes were applied to the muscle surface either with sutures or with small amounts of cyanoacrylate adhesive (Zapagap) on patch corners. To approach the diaphragm (pars costalis), the surface of the abdominal wall was exposed by retracting a dorsal, sagittal incision laterally to the level of the midaxillary line. Incisions into the wall were located 2–3 mm caudal to the costal margin to avoid the pleural cavity. An initial incision, approximately

4 mm in length, was made parallel to the fibers of the obliquus abdominis internus. If possible, the transversus abdominis was incised separately, parallel to its fibers. When the incision into the abdominal cavity was completed, the patch electrode was inserted with the receptive surface oriented cranially and in contact with the diaphragm. The first suture to close the incision was looped around the lead to secure it. The remainder of the incision was closed with 7-0 synthetic sutures. When hook electrodes were used, they were inserted with a 27 gauge hypodermic needle. All electrode leads were secured to fascia with a suture. Leads were given sufficient slack to allow for movement and were passed subcutaneously to an externalized connector on the back.

Connectors were made from single-row, right-angled, square-post headers (2.5 mm center space, AMP Inc., Harrisburg, Pennsylvania) attached to 10 mm × 20 mm silastic patches. Right-angled connectors had the advantage of allowing the attachment and detachment of the cable without direct pressure or tension on the animal's back. After implantation, the skin was closed over the connector patch. Two sutures (6-0 silk) were passed through the skin and the patch to secure the entire assembly to the skin. The remainder of the incision was closed with sutures (6-0 silk or 7-0 synthetic). This attachment method was well-suited to the small size of the animal and the lack of a bony surface of sufficient size to which connectors could be mounted. It allowed a sufficient degree of flexibility along with attachment that would remain secure for over 1 week. In most cases, two muscles were implanted in each animal.

### Recording

Recordings were made in stationary and flying bats. In the stationary situation, a shielded, four-wire, miniature cable (NMUF 4/30, Cooner Wire Co., Chatsworth, California) was connected to a custom made, two-channel, instrumentation amplifier [gain 200, bandpass filter 1–3 kHz, based on AD625 instrumentation operational amplifier (Analog Devices, Norwood, Massachusetts)]. All signals were recorded at  $38 \text{ cm s}^{-1}$  on a Lockheed Electronics (Store 4D) instrumentation tape recorder. Subjects were placed in a small, steel-mesh cage (25 cm × 25 cm × 25 cm). A stationary

microphone (6.25 mm Brüel and Kjør) recorded the vocalizations (through a 20 kHz highpass filter) onto a direct channel of the tape recorder in order to correlate vocal emissions with muscle activity. Both implanted muscles were monitored simultaneously. The distance from the microphone to the animal was sufficiently small (typically 25 cm or less) for time delays to be negligible. Recordings were made while the animal hung in the cage, free to move about. Sufficient slack was allowed in the cable to avoid tension on the connectors and the bat seldom became entangled. Voiced comments describing the bat's activity were made on the tape. Sessions typically lasted 30–60 min.

During flight, electromyographic and biosonar signals were telemetered with a small FM radio transmitter. The original design used an electret microphone that detected broad-band audio signals. The low-frequency (<10 kHz) myopotential and the ultrasonic signal (approximately 61 kHz) were summed and transmitted. In a modified design, the electret microphone was replaced with a Panasonic ceramic-crystal microphone (P9935-ND) (Figs 1 and 2) that was tuned to match more closely the dominant frequency of the bat's biosonar signal. Tuning was accomplished by removing the protective case and chipping away small pieces of the ceramic disc. The frequency response was checked until the resonance frequency was shifted to the desired band. Summated signals were separated by the receiver. Only one muscle could be monitored at a time. Simultaneously recorded echolocative vocalizations were used as a reference to correlate activity patterns of the different muscles.

The transmitter was attached to bare skin of the head. During surgical preparation, the bat's head was tonsured with depilatory cream (Neet). The skin and a contoured, plastic attachment-cap of the transmitter were thinly coated with cosmetic latex (Lashgrip eyelash adhesive). The latex was allowed to dry before the device was pressed into place. Next, the transmitter's EMG cable was attached to one of the two connectors on the back. The attachment procedure was performed on conscious animals and did not appear to cause overt distress beyond that associated with gentle restraint. Animals seemed to acclimate to the presence of the apparatus and seldom attempted to dislodge it. After recording from one

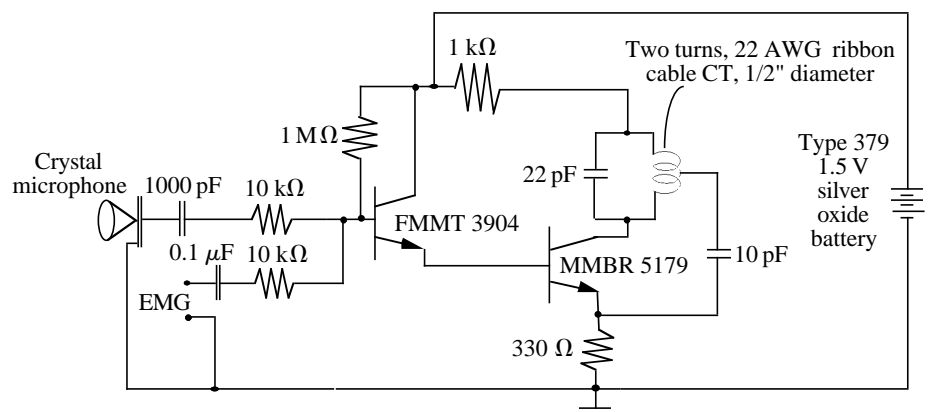

Fig. 1. Diagram of the FM transmitter.

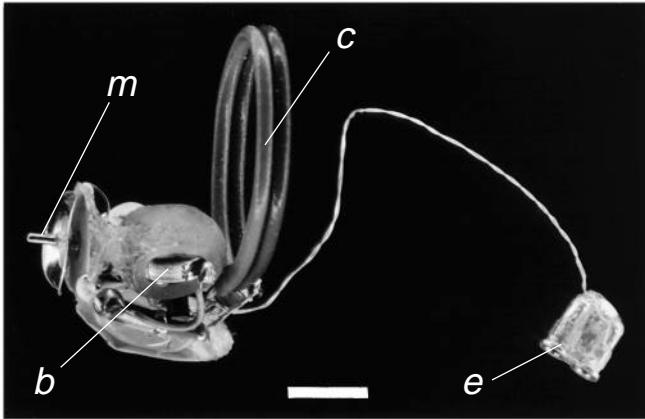

Fig. 2. Photograph of the FM transmitter. Scale bar, 5 mm. *b*, battery; *c*, coil; *e*, electromyographic (EMG) connector; *m*, microphone.

muscle, the EMG cable was switched to the other connector. At the end of the experiment, the transmitter was easily removed. We observed no discernible irritation to the skin. Bats used in these experiments carried the transmitter without apparent handicap for periods approaching an hour. After that, some showed signs of fatigue, as evidenced by impaired maneuverability or frequent landing. To eliminate fatigue as a complicating factor, animals were allowed to rest at will, and recording sessions seldom extended beyond 45 min.

Flights were conducted in a 650 cm × 150 cm × 240 cm section of a corridor, enclosed at each end with a net. Bats were allowed to fly up and down the chamber at will. In some flights, obstacles (5 mm diameter cables) were hung in the flight path to induce changes in pulse (vocalization) repetition rate. Voiced comments were recorded directly onto the tape to indicate when the animal flew, turned, landed or approached an obstacle.

Telemetered signals were received by a pair of folded-dipole antennae (300 Ω antenna wire). Reception was best in the near-field when the animal flew past the antenna array. Signal strength diminished at ranges beyond approximately 3 m. The transmitter output was received with a commercial FM tuner (Harmon and Kardon, model T403), equipped so that high-frequency signals could be recorded from the discriminator. EMG signals were recorded from the audio output of the tuner.

To study the relationship between respiratory muscle activity and locomotion, it was necessary to correlate the activity of flight muscles with vocalization. This objective was accomplished by recording potentials of the pectoralis and the serratus ventralis in flight in relation to vocalization. With the electromyographic data, wing position was inferred from other studies that have correlated wing movements with flight muscle activity in bats and birds (Hermanson and Altenbach, 1981, 1983, 1985; Biewener *et al.* 1992; Dial *et al.* 1991).

After completion of electromyographic recordings, the first four animals were killed (Methoxyflurane) and the position of the electrodes was verified by dissection and histological

sectioning of the underlying muscles. In the last five animals, we exposed the electrodes after recordings were completed to verify their position. Electrodes and connectors were removed, incisions were sutured and the animals recovered.

#### Analysis

Selected recordings were printed on an electronic chart recorder (Gould ES 1000). Aspects of pulse and myopotential timing were tabulated by measuring sequential onsets and terminations of pulses and myopotentials using custom-built software and a computer-controlled digital oscilloscope. Sequences of 5 s duration were examined at a time. Onsets and terminations were determined by signals that exceeded an automated detection routine. Threshold was left at the default setting, but could be adjusted manually in the case of a sequence with poor signal-to-noise ratio. A minimum myopotential duration was set, so that artifacts with durations of less than 1.875 ms were undetected. The routine allowed subthreshold gaps of 1.25 ms within a myopotential before resetting for detection. Using these raw data, we calculated the following variables: pulse duration, myopotential duration, interpulse interval, intermyopotential interval and instantaneous pulse repetition rate. Specific variables were quantified for individual muscles. For the musculature of the abdominal wall, myopotential–pulse lead time and myopotential–pulse overlap were determined. For the diaphragm, instantaneous myopotential repetition rate (equivalent to instantaneous respiration rate), pulse–myopotential interval, myopotential–pulse interval and respiratory period were calculated. For the pectoralis and serratus ventralis, instantaneous myopotential repetition rate (wingbeat frequency) was established.

Means of variables were calculated for each measured sequence and used to calculate overall means and standard deviations for all sequences for each bat. Analysis of variation (ANOVA run on SAS) was used to calculate *P*-values for each variable between flying and resting situations. Associations between selected variables pooled from all bats were tested using ANOVA. All tests employed a rejection criterion of  $P \leq 0.05$ .

Since the activities of different muscles were not recorded simultaneously, vocalization was used as the variable by which all muscle activities were correlated. The average timing of bursts relative to the onset of a vocal pulse was established. A hypothetical series of pulses was then proposed and average timing patterns of different muscles were assigned to reflect typical muscle activity within a range of variation. For muscles that directly affected vocalization, such as the muscles of respiration, this was an unambiguous task. Ranges of variation were greater for muscles whose activity relative to vocalization was not directly causal, but was surmised to be synchronized. In the case of flight muscles, data were selected that reflected steady flight. Recordings of flight muscles were also made when the animal was at rest but, since no clear pattern of activity was observed, no quantitative data were obtained.

Fig. 3. Photograph of the vertebral column, ventral view (A) and the costovertebral articulations (B) of *Pteronotus parnellii*. In B, the ventral portions of the ribs have been removed. Scale bars: A, 10 mm; B, 1 mm. *b*, body; *c*, capitulum; *p*, pedicle; *s*, thoracolumbar synostosis.

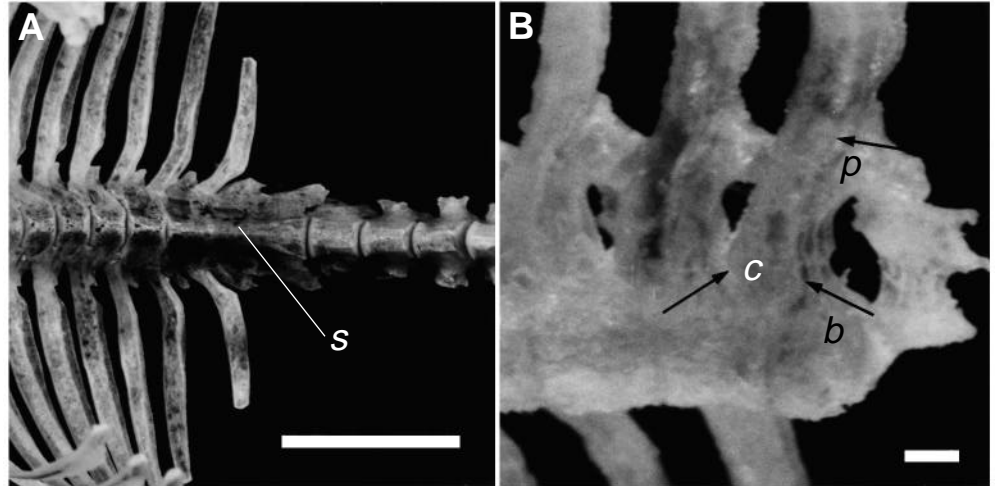

## Results

### Osteology

Vaughan (1959, 1970a) gave general descriptions of the skeleton of bats; *Pteronotus parnellii* conforms to the general features and range of variation that Vaughan described. Here, we focus on details of the bones and joints of the thoracic cage and limit descriptions to features that pertain to respiratory mechanics.

Of thirteen thoracic vertebrae, the first ten are separate elements. The last three, along with the first lumbar vertebra, fuse into a thoracolumbar synostosis (Fig. 3A). The vertebrae of the thoracolumbar synostosis are completely fused, both bodies and neural arches, with no visible vestiges of segmentation except for the normally formed ribs and transverse process. Three or four free lumbar vertebrae occur caudal to the synostosis. On the body of the fifth lumbar vertebra, a semi-rounded caudal articular surface articulates with the sacrum. This articulation appears to account for much of the mobility between the trunk and pelvis.

The first three costovertebral articulations have the bicapital form typical of mammals. Articulations between the rounded

capitula and the vertebral bodies, and between the tubercula and the transverse processes, suggest that these first three ribs are capable of some rotation. Starting with the fourth thoracic vertebra, the pedicle comes into apposition with the neck of the rib caudally, to provide a buttress from the tuberculum to the capitulum. At this level, the capitulum is wedge-shaped, extending deeply between adjacent thoracic vertebrae. The buttressing, coupled with the interlocking array of ribs and vertebrae, results in a solid attachment of ribs to the vertebral column, suggesting that little rotation of the ribs occurs caudal to the third rib (Fig. 3B).

### Myology

Previous descriptions of the general musculature of bats focused on specializations for flight and to a lesser degree on the hind limbs (Macalister, 1872; Vaughan, 1959, 1970b; Mori, 1960). These studies gave little attention to musculature responsible for ventilation of the lungs. Here we describe the diaphragm, the musculature of the lateral abdominal wall and the rectus abdominis. The thoracic musculature is briefly described as it pertains to flight and points of interest relative to our experiments.

Fig. 4. Photographs of the diaphragm, pars costalis, caudal surface (A) and pars lumbalis, ventral view (B) of *Pteronotus parnellii*. Scale bars, 5 mm. *c*, pars costalis; *l*, pars lumbalis; *t*, centrum tendineum.

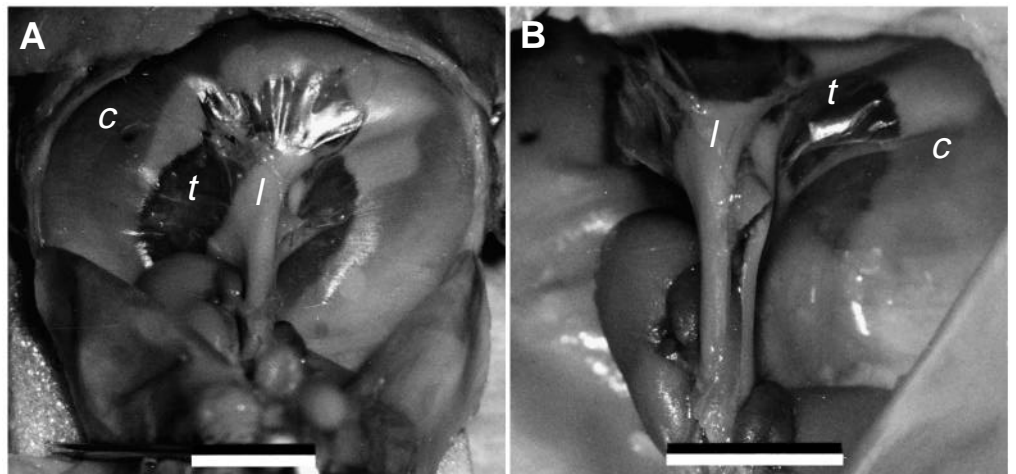

### Diaphragm

The diaphragm consists of three muscular components and the centrum tendineum. The muscular components, named according to their bony attachments, are the pars costalis, pars sternalis and pars lumbalis. Fascicles of these components radiate towards and attach to the centrum tendineum. The centrum tendineum is thin (10–20  $\mu\text{m}$ ) and transparent (Fig. 4A). Both the pars costalis and the pars sternalis are 200–300  $\mu\text{m}$  thick. The pars costalis attaches to the dorsal body wall at the cranial extremity of the thoracolumbar synostosis. Laterally, the attachment follows a line along the tips of the twelfth and eleventh ribs and the costal margin to the xiphisternum.

The pars lumbalis (Fig. 4B) consists of two markedly asymmetrical crura, the right one being larger. Both crura consist of craniocaudally oriented fascicles that originate from the third or fourth lumbar vertebra and attach to the centrum tendineum. Both have a thick ventral border and become thin at the attachment to the dorsal body wall. Cranially, the crura form a common hiatus for the aorta and esophagus.

### Muscles of the abdominal and thoracic walls

As in other mammals, the thoracic and abdominal walls consist of three muscle layers and a ventral, longitudinally oriented rectus abdominis. In the abdomen, the obliquus externus abdominis, obliquus internus abdominis and transversus abdominis are typically distinguished by differing orientations of fibers. In general, fibers attach to the thoracolumbar fascia and to the linea alba (*via* the rectus sheath), inguinal ligament and costal margin (Fig. 5).

*Obliquus externus abdominis.* This thin muscle (35–50  $\mu\text{m}$ ) usually consists of two cell layers, but fascicles are not consistently present. From their origin, fascicles course ventrally and slightly caudally.

*Obliquus internus abdominis.* Fascicles of this layer trend ventrally and cranially, forming a sheet that ranges from 100 to 200  $\mu\text{m}$  in thickness. At its attachment to the costal margin, this layer is aponeurotic. Muscle fibers commence approximately 1000–2000  $\mu\text{m}$  caudally.

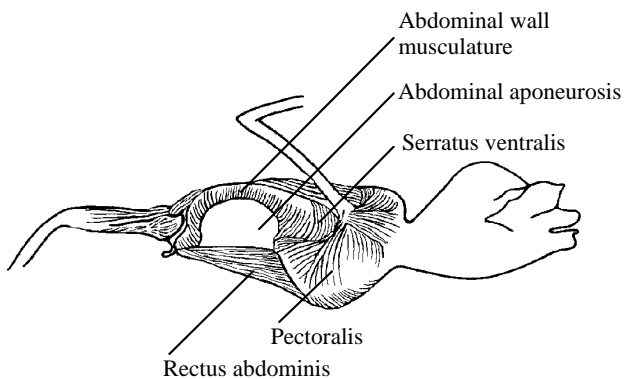

Fig. 5. Musculature of body wall of *Pteronotus parnellii*, lateral view. The obliquus externus abdominis is not depicted.

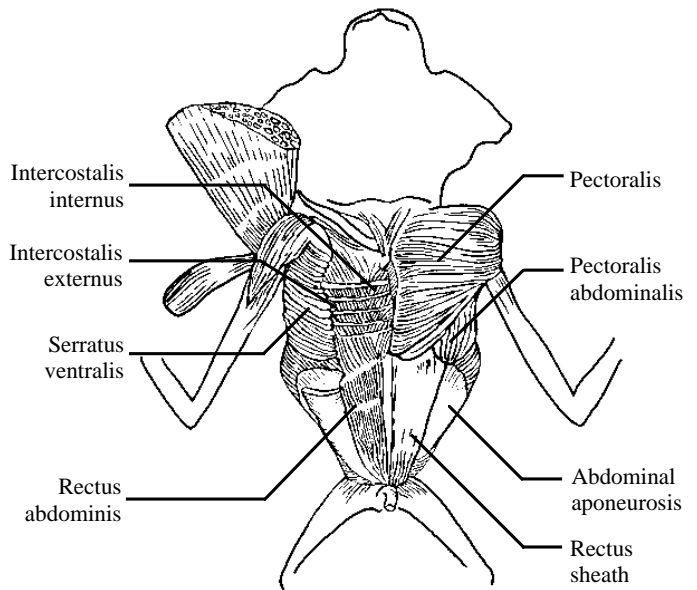

Fig. 6. Musculature of body wall of *Pteronotus parnellii*, ventral view. The obliquus externus abdominis is not depicted.

*Transversus abdominis.* Unlike the other layers, the transversus abdominis is uniformly distributed from muscular attachments to the vertebral ribs, costal margin and thoracolumbar fascia, to an aponeurotic attachment to the ilium in common with the obliquus internus. It ranges from 200 to 300  $\mu\text{m}$  in thickness and fibers course transversely, attaching to the abdominal aponeurosis.

*Abdominal aponeurosis.* Ventrolaterally, much of the abdominal wall is represented by an aponeurosis (Fig. 5). The junction of muscle fibers and the aponeurosis follows a broad arc. Concave ventrally, this junction extends from the pectoralis cranially to the rectus abdominis caudally. At its dorsal-most extent, the margin reaches the midaxillary line. Ventrally, the aponeurosis becomes confluent with the lateral edge of the rectus sheath. Only fibers of the obliquus internus and transversus abdominis attach directly to the aponeurosis.

*Rectus abdominis.* This long, flat, segmented muscle extends along the ventral surface of the abdominal wall. It attaches to the superior rami of the pubis caudally and to the superficial surface of ribs 5–10 (Figs 5 and 6). The rectus abdominis is enclosed in a sheath composed of collagenous fibers continuous with the abdominal aponeurosis. Muscle fibers of the lateral abdominal wall contact the rectus sheath only at its cranial and caudal extremities.

*Transversus thoracis.* This rhomboidally shaped, 120–160  $\mu\text{m}$  thick muscle attaches to the deep surface of the sternum medially and to the ventral extremities of ossified portions of ribs laterally (Fig. 7). The caudal border runs obliquely from the sternum to the fourth or fifth rib; the cranial border runs from the sternum to the first rib. Muscular fibers extend from the sternum approximately 3 mm laterally, and grade into a delicate aponeurosis.

Fig. 7. Photomicrographs of transverse sections through the transversus thoracis and associated structures of the ventral thoracic cage in *Lasiurus borealis* (A) and *Pteronotus parnellii* (B). B is a montage. Scale bars, 250  $\mu$ m. *ii*, intercostales internus; *tt*, transversus thoracis; *st*, sternum.

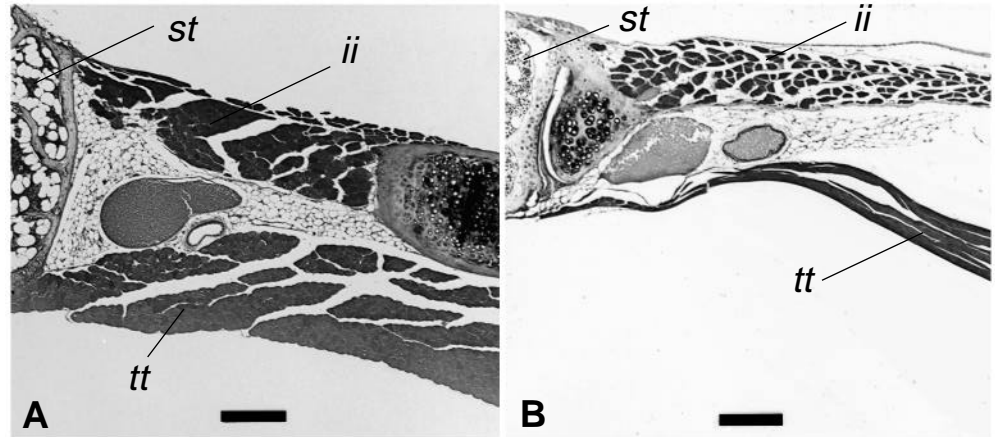

### Flight muscles

**Pectoralis.** The pectoralis is the major muscle that powers the downstroke of flight. This massive muscle extends from the sternum to the humerus, covering most of the ventral aspect of the thorax (Figs 5 and 6). In *P. parnellii*, it follows the general plan described in other bats (Hermanson and Altenbach, 1985).

**Serratus ventralis.** The serratus ventralis extends from the lateral surface of the thoracic cage to the axillary border of the scapula and counteracts dorsal displacements of the scapula in flight. In *P. parnellii*, it is similar to that of other bats (Hermanson and Altenbach, 1985).

### Muscle activity in relation to vocalization: stationary bats

Bats confined to small cages usually emitted copious vocalizations. Typically, these calls had a structure indistinguishable from the ultrasonic biosonar pulses used by *P. parnellii* in flight; these consisted of an extended constant-frequency tone followed by a brief, descending frequency modulation (Henson *et al.* 1987). Additionally, a variety of signals with both ultrasonic and audible components were recorded that had great variation in frequency and envelope structure. These vocalizations were studied by Kanwal *et al.* (1992) and, for descriptive purposes, are broadly categorized as communicative vocalizations.

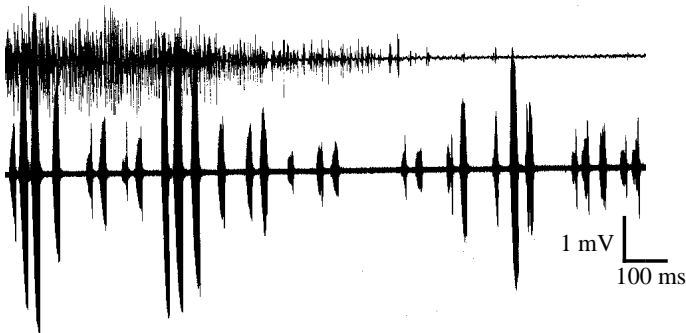

Fig. 8. Activity of the rectus abdominis (upper trace) in relation to biosonar vocalization in a stationary bat. The amplitude scale applies only to the electromyogram.

### Rectus abdominis

Electromyograms from the rectus abdominis of two bats showed no activity patterns correlated with echolocative vocalization, regardless of pulse intensity or repetition rate. Activity of the rectus abdominis varied widely compared with that of other abdominal muscles. Potentials typically appeared as long bursts of variable amplitude. Activity sometimes lasted 1–2 s, followed by quiet periods ranging from approximately 100 ms to 1 s (Fig. 8). Increases in rectus abdominis activity were concurrent with motion, presumably flexion of the trunk. High rates of vocalization often attended overt movements of the trunk. Such movement accompanied activity in the rectus abdominis, but specific correlations were not made.

### Lateral abdominal wall

In the four bats for which data on the activity of the lateral abdominal wall were quantified, a consistent pattern of activity appeared in relation to echolocative vocalization (Fig. 9). A discrete burst of activity accompanied each of 2179 vocalizations. In most cases, the myopotential began before the pulse onset and terminated prior to the end of the pulse. This



Fig. 9. Activity of the lateral abdominal wall muscles (upper trace) in relation to biosonar vocalization in a stationary bat. The amplitude scale applies only to the electromyogram.

Table 1. *Timing of myopotentials recorded from the lateral abdominal wall relative to biosonar vocalization; overall means from resting (29 recordings) and flying (24 flights) bats*

Variable	Flying	Resting	<i>P</i>
Myopotential duration (ms)	20.3	25.1	0.0456*
(S.E.)	(0.90)	(0.86)	
<i>N</i>	1016	1163	
Vocalization duration (ms)	16.0	19.8	0.0051*
(S.E.)	(0.51)	(0.38)	
<i>N</i>	1016	1163	
Myopotential lead (ms) <sup>a</sup>	12.9	15.6	0.0549
(S.E.)	(0.72)	(0.65)	
<i>N</i>	1010	1154	
Vocalization/myopotential overlap (ms) <sup>b</sup>	7.5	9.4	0.1227
(S.E.)	(0.56)	(0.59)	
<i>N</i>	1011	1163	
Vocalization instantaneous repetition rate (pulses s <sup>-1</sup> )	32.3	19.5	0.0011*
(S.E.)	(7.58)	(1.66)	
<i>N</i>	987	1134	

\**P*<0.05.

<sup>a</sup>Difference between onset of myopotential and vocalization.

<sup>b</sup>Duration of overlap between myopotential and vocalization.

relationship was consistent in both flying and stationary bats at all pulse repetition rates, durations and apparent intensities. A quantitative summary of myopotential and pulse activity patterns appears in Table 1.

In stationary bats, the onset of bursts in the lateral abdominal wall preceded the pulse onset by an average of 16 ms and ended 9 ms after pulse onset. In this situation, mean pulse duration was near 20 ms and myopotential duration averaged 25 ms.



Fig. 10. Activity of the lateral abdominal wall muscles (upper trace) in relation to low-repetition-rate biosonar vocalization (lower trace) in a stationary bat. Note that some myopotentials are not associated with pulses. The amplitude scale applies only to the electromyogram.

Bursts from the lateral abdominal wall musculature occasionally occurred without an associated vocalization (Fig. 10). We interpreted these myopotentials as active expiratory events. This activity was quantified primarily from 14 data sets recorded from one bat, but activity patterns observed in other bats were similar. The myopotentials most commonly appeared shortly after the animal had been placed in the cage and was agitated or during and after times when the bat actively moved about in the cage. These bursts resembled vocalization-related myopotentials. They had similar sharp onset and termination times, but were typically about 5 ms shorter ( $21.9 \pm 1.8$  ms,  $N=178$ ). Myopotentials occurred  $24.8 \pm 4.95$  ms ( $N=168$ ) after a single pulse or a two-pulse group. Following an expiratory burst, an average of  $93.2 \pm 15.60$  ms ( $N=163$ ) elapsed until the next vocalization.

The occurrence of presumed expiratory myopotentials appeared to correlate with pulse repetition rate and the number of pulses per group. Bats emitted pulses in groups of one or two during periods of moderate repetition rate ( $10\text{--}20$  pulses s<sup>-1</sup>). At higher rates ( $25$  pulses s<sup>-1</sup> and greater), pulses usually occurred in groups of three to six; the intervals between groups were short and expiratory myopotentials seldom appeared. High repetition rates usually accompanied states of high activity in the cage. When animals stopped moving, they appeared to be panting and expiratory myopotentials occurred after almost every pulse group. When intervals between groups extended to 1 s or more, several successive expiratory bursts sometimes occurred. In these situations, up to 40% of the myopotentials had no attending vocalizations. After the bat had calmed, there was less apparent exertion in respiration and the proportion of myopotentials without associated vocalizations dropped to approximately 8%. The number of these bursts, as a percentage of total myopotentials in a sequence, bore a close, negative correlation with pulse repetition rate ( $r^2=0.729$ ,  $N=11$  sequences).

When calm, bats often ceased vocalization for periods of a minute or more. In such situations, no phasic activity was

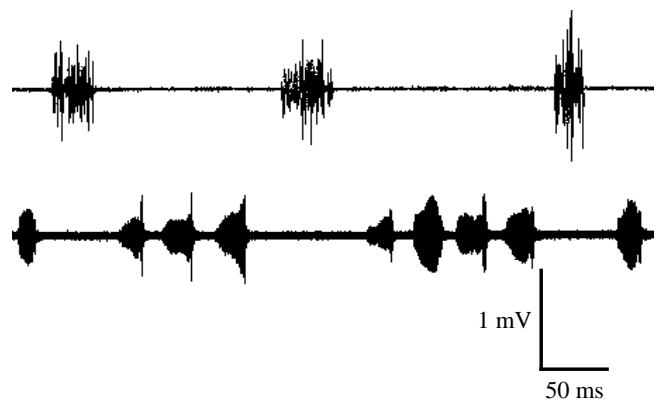

Fig. 11. Activity of the diaphragm (pars costalis) (upper trace) in relation to biosonar vocalization (lower trace) in a stationary bat. The amplitude scale applies only to the electromyogram.



detected in the lateral abdominal wall that might reflect active expiration; respiration, however, was not directly monitored.

#### Diaphragm

Myopotentials from the diaphragm consistently occurred during intervals between pulse groups (Fig. 11). A quantitative summary of diaphragmatic myopotential patterns appears in Table 2. In stationary bats, these myopotentials had a mean duration of 35 ms and began on average 24 ms after the termination of the preceding pulse, but a wide range of variation was seen. Characteristics of bursts in the diaphragm varied with pulse repetition rate. At high rates, bursts were short and of high amplitude; onset and termination were abrupt. During the lowest rates of pulse emission, in which interpulse intervals sometimes exceeded 0.5 s, myopotential durations lasted 100 ms or more. In these bursts, amplitude increased and decreased gradually at onset and termination.

In the absence of vocalization, diaphragmatic activity changed. Myopotential duration increased sevenfold, to an average  $166.1 \pm 4.22$  ms ( $N=28$ ) and intervals between myopotentials decreased to  $66.1 \pm 2.39$  ms. During these times, respiration rate averaged 4.33 Hz. From onset, the amplitude of these myopotentials increased gradually and decayed slowly to the termination.

#### Muscle activity in relation to vocalization: flying bats

##### Rectus abdominis

Rectus abdominis activity was not successfully recorded in flight.

##### Lateral abdominal wall

During flight, activity of the lateral abdominal wall in relation to echolocative pulse emission resembled that in resting bats (Table 1). A discrete burst of activity began prior

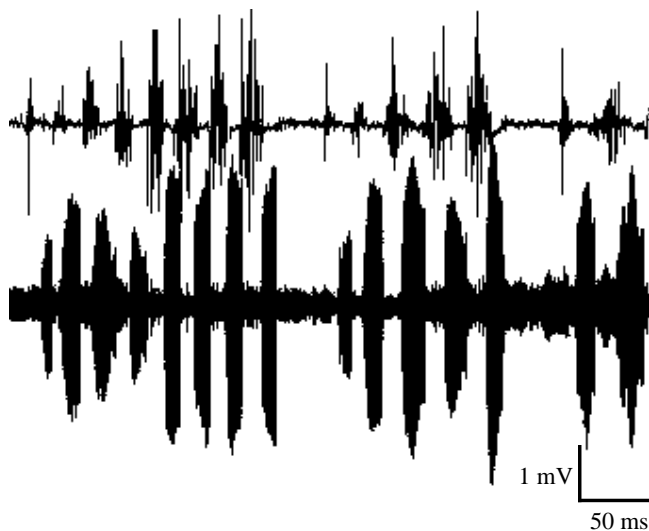

Fig. 12. Activity of the lateral abdominal wall muscles (upper trace) in relation to biosonar vocalization (lower trace) in a flying bat. The amplitude scale applies only to the electromyogram.

Table 2. Timing of myopotentials recorded from the diaphragm relative to biosonar vocalization; overall means from resting (11 recordings) and flying (11 flights) bats

Variable	Flying	Resting	<i>P</i>
Myopotential duration (ms)	28.8	35.4	0.0045*
(S.E.)	(1.67)	(2.86)	
<i>N</i>	261	327	
Vocalization duration (ms)	13.8	18.0	0.0465*
(S.E.)	(0.39)	(0.44)	
<i>N</i>	529	401	
Myopotential instantaneous repetition rate (respiratory rate) (bursts s <sup>-1</sup> )	9.1	12.0	0.7663
(S.E.)	(0.40)	(2.00)	
<i>N</i>	246	315	
Vocalization instantaneous repetition rate (pulses s <sup>-1</sup> )	23.3	19.1	0.0433*
(S.E.)	(1.78)	(1.47)	
<i>N</i>	508	390	
Myopotential to vocalization interval (ms)	18.9	32.1	0.0969
(S.E.)	(1.58)	(7.34)	
<i>N</i>	243	171	
Vocalization to myopotential interval (ms)	13.2	23.5	0.1820
(S.E.)	(2.40)	(6.27)	
<i>N</i>	251	181	
Respiration period (s)	111.2	131.0	0.1507
(S.E.)	(4.77)	(10.31)	
<i>N</i>	241	316	

\* $P < 0.05$ .

to each vocalization and ended before the termination of the vocalization in search and approach-phase echolocation calls (Fig. 12) (as characterized by Griffin *et al.* 1960). The onset of bursts preceded pulse onset by an average of 13 ms and bursts ended 8 ms after pulse onset. Mean pulse duration was 16 ms and myopotential duration averaged 20 ms. Durations of myopotentials and pulses and instantaneous pulse repetition rates were significantly different between flying and stationary bats. Differences in myopotential lead between flying and stationary bats had a *P*-value slightly greater than the rejection criterion and pulse-myopotential overlaps were not significantly different.

The highest rates of pulse repetition usually accompanied landings, turns or the approach to obstacles. Pulse emission sequences considered to represent terminal phase (Griffin *et al.* 1960) typically consisted of one or two groups of 5–13 pulses per group, emitted over periods of 100–200 ms. Pulses emitted during these sequences were characterized by low amplitude and repetition rates of 70–90 pulses s<sup>-1</sup>. Some high-repetition-rate sequences were not considered to be terminal phase because their pulses were higher in amplitude and emitted in

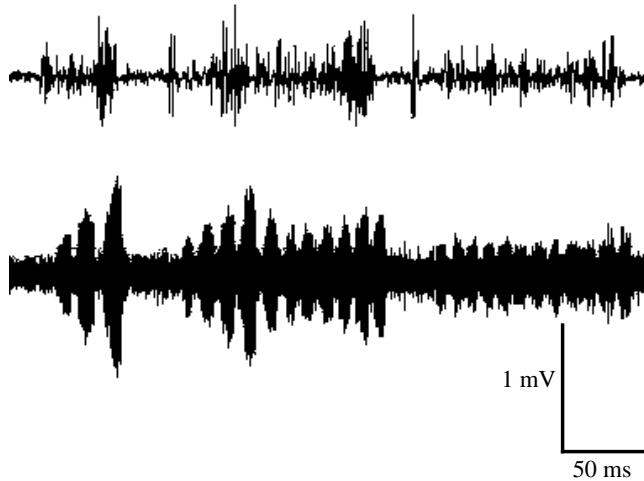

Fig. 13. Activity of the lateral abdominal wall muscles (upper trace) in relation to biosonar vocalization (lower trace) in a flying bat. This sequence depicts terminal phase echolocation; note that myopotentials are less distinct at the highest rates of repetition. The amplitude scale applies only to the electromyogram.

shorter sequences at lower rates of repetition. Abdominal wall activity accompanying terminal-phase and high-repetition-rate sequences showed more variation than in search or approach-phase sequences. Discrete myopotentials preceding each pulse were evident at repetition rates of up to  $50\text{ s}^{-1}$ . However, at higher repetition rates, intervals between myopotentials sometimes diminished to the point of imperceptibility (Fig. 13). No specific threshold of repetition rate could be

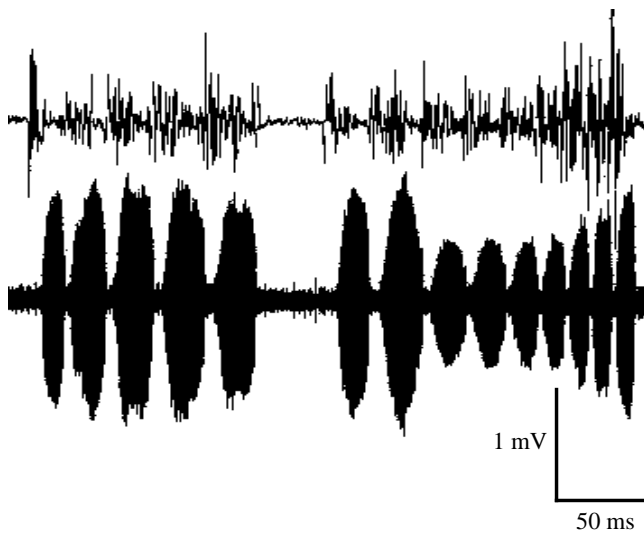

Fig. 14. Activity of the lateral abdominal wall muscles (upper trace) in relation to biosonar vocalization (lower trace) in a flying bat. This sequence depicts a high rate of repetition that is not terminal phase. Note that discrete myopotentials occur early in the pulse groups, but become less discernible towards the end of pulse groups. The amplitude scale applies only to the electromyogram.

defined as the upper limit of discrete myopotentials. In some high-repetition-rate sequences, discrete myopotentials accompanied the initial two or three pulses, with intervals between succeeding bursts becoming indistinct (Fig. 14). Sometimes, this appeared to relate to the interval between successive pulses; those separated by intervals of less than 4 ms seldom had unambiguous intervals between related myopotentials. In most instances of terminal-phase sequences, the signal-to-noise ratio was inadequate to allow intervals to be measured accurately.

Activity in the lateral abdominal wall that seemed to reflect forceful expirations occurred during flight in all bats tested and resembled that recorded from bats at rest. Bursts were typically associated with single pulses but also occurred after two-pulse groups; they were never seen following pulse groups of three or more. In sequences from one bat, the duration of the presumed respiratory myopotentials in flight averaged  $23.0 \pm 0.69$  ms ( $N=69$ ), not significantly different ( $P>0.1$ ) from the  $21.9 \pm 1.8$  ms mean respiratory myopotential duration at rest. In the same sequences, myopotentials that were associated with pulses averaged  $17.6 \pm 0.31$  ms ( $N=79$ ), significantly shorter than the respiratory myopotentials.

#### Diaphragm

The activity of the diaphragm was qualitatively similar during flight and at rest (Table 2). Myopotentials consistently occurred during intervals between pulse groups, usually starting 13 ms after the termination of the last pulse in a sequence (Fig. 15). The duration of diaphragmatic myopotentials in flight averaged 29 ms. As for resting sequences, the duration and amplitude of myopotentials in flight varied with repetition rate and hence with the interval between pulse groups. Long intervals were associated with myopotentials of long duration. The short intervals between groups of pulses emitted at a high rate of repetition correlated with short, intense periods of activity in the diaphragm. After several short breaths in sequence, activity that appeared to represent an augmented breath sometimes occurred (Fig. 15). In these cases, the myopotentials lasted over 100 ms.

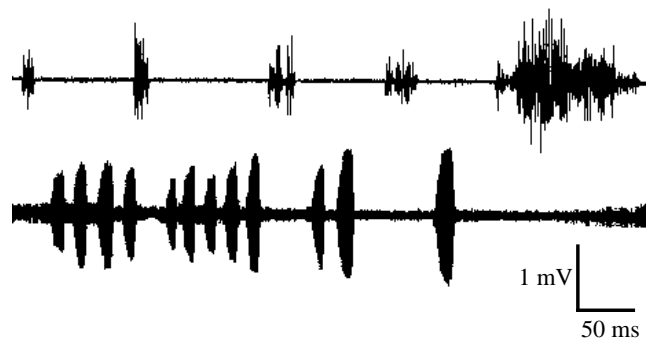

Fig. 15. Activity of the diaphragm (pars costalis) (upper trace) in relation to biosonar vocalization (lower trace) in a flying bat. Note the augmented breath following the succession of several short inspirations. The amplitude scale applies only to the electromyogram.



Fig. 16. Activity of the pectoralis (upper trace) in relation to biosonar vocalization (lower trace) in a flying bat. The amplitude scale applies only to the electromyogram.

Augmented breaths (see Discussion) coincided with unusually long intervals between pulse groups and the amplitude of myopotentials decayed gradually. They shared characteristics with diaphragmatic bursts during resting sequences when vocalizations were infrequent. As for recordings from the lateral abdominal wall, myopotential and pulse durations and pulse instantaneous repetition rates were significantly different between flying and resting bats as measured with respect to the diaphragm (Table 2). Other timing variables did not differ significantly. Low-amplitude spikes during vocalizations, like those seen in stationary bats, were seldom seen during flight. They were also infrequent when the bat was resting between flights.

#### *Pectoralis*

No pectoralis muscle activity occurred while the bat was stationary, regardless of vocal activity. Flight recordings from the pectoralis revealed strong rhythmic bursts similar to those

seen by Hermanson and Altenbach (1981, 1983, 1985). Correlation between vocalization and activity of the pectoralis in flight followed a consistent pattern, but the relationship was more plastic than in the case of respiratory muscles. In steady flight, when the bat was emitting a regular pattern of pulses with one or two calls per group, pulse groups coincided with the myopotentials (Fig. 16). For a two-call group, the first pulse typically began before the onset of the burst. The second pulse usually occurred near the end of the myopotential and continued until after its termination. Single pulses occurred near the beginning of bursts. In groups of three or more calls (as compared with double-pulse groups), the first pulse began earlier and the last call later, relative to the burst. During landings, turnings or the avoidance of obstacles, high-repetition-rate calls continued throughout the period of the pectoralis myopotential, the succeeding relaxation and into the next burst.

A quantitative summary of pectoralis and serratus ventralis activity patterns relative to pulse emissions is presented in Table 3. The durations of myopotentials in the pectoralis averaged 43 ms and the average interval between bursts was 55 ms. Fig. 17 depicts the relationship between the onsets of pulses and pectoralis myopotentials in steady flight; take-offs and landings are not included. In this bimodal distribution, 31.5% of pulses began 0–10 ms prior to myopotential onset and 24.6% occurred 30–40 ms after myopotential onset.

#### *Serratus ventralis*

The relationship between activity of the serratus ventralis and vocalization (Fig. 18) closely resembled that of the pectoralis. The mean myopotential duration of the serratus ventralis was 38 ms and the myopotential interval averaged 54 ms. Owing to the plasticity of vocalization in relation to flight muscle activity and the inherent lack of precision of vocalization as a time marker, direct comparisons of pectoralis and serratus ventralis activity could not be made.

Fig. 19 is a composite diagram correlating the activities of

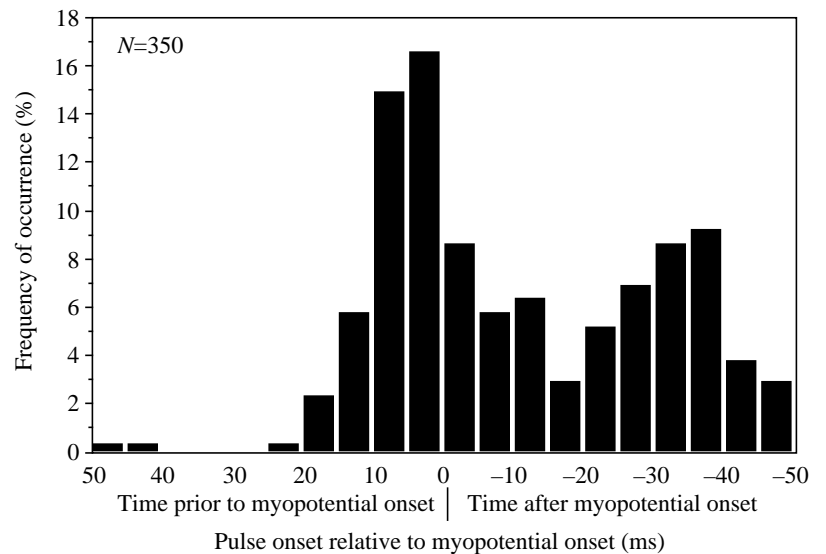

Fig. 17. Histogram depicting the time of pulse onset relative to the onset of pectoralis myopotentials for 350 pulses.

Table 3. *Timing of myopotentials recorded from the pectoralis (six flights) and serratus ventralis (five flights) relative to biosonar vocalization; overall means from one bat in flight*

Variable	Pectoralis	Serratus ventralis
Myopotential duration (ms)	42.9	37.6
(S.E.)	(1.32)	(1.48)
<i>N</i>	219	129
Vocalization duration (ms)	13.0	9.9
(S.E.)	(0.41)	(0.37)
<i>N</i>	438	321
Myopotential interval (ms)	54.9	53.7
(S.E.)	(2.12)	(4.03)
<i>N</i>	214	124
Myopotential instantaneous repetition rate (wingbeat frequency) (bursts s <sup>-1</sup> )	10.5	11.6
(S.E.)	(0.31)	(0.65)
<i>N</i>	214	124
Vocalization instantaneous repetition rate (pulses s <sup>-1</sup> )	30.9	43.0
(S.E.)	(2.36)	(3.33)
<i>N</i>	432	315

four muscles with vocalization in flight. The length of each bar is proportional to the mean durations of bursts as they occurred in relation to double or single pulses; error bars represent standard error. This diagram shows the one-to-one relationship between myopotentials of the lateral abdominal wall and vocalizations and the placement of bursts of the diaphragm between pulse groups. Bursts in the abdominal wall, and hence vocalizations, roughly coincide with activity of flight muscles. Inspiration, which can be assumed to follow contractions of the diaphragm, did not coincide with vocalizations, with activity of the lateral abdominal wall or with activity of the major downstroke musculature.

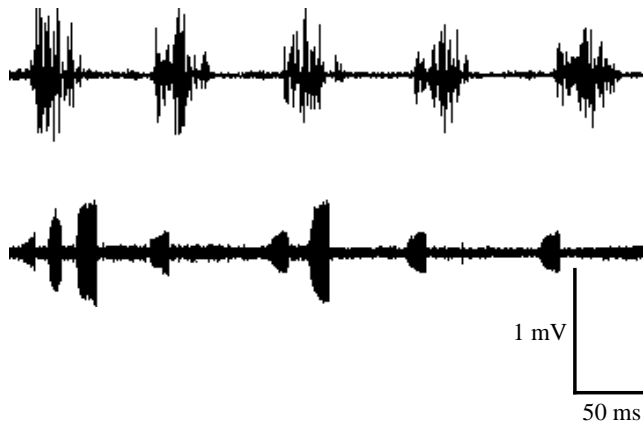

Fig. 18. Activity of the serratus ventralis (upper trace) in relation to biosonar vocalization (lower trace) in a flying bat. The amplitude scale applies only to the electromyogram.

## Discussion

Our data demonstrate morphological and physiological features that influence respiration and vocalization in *Pteronotus parnellii*. Here, we discuss respiratory muscle activity in relation to vocalization and the differences in respiratory muscle activity between flying and resting bats. We will consider how these relationships validate the integration of vocalization and locomotion and contribute to the economical production of biosonar pulses in flight.

### *Muscle activity in relation to vocalization*

On the basis of the data presented here, it is clear that activity of muscles of the lateral abdominal wall correlates with vocalization. Although the larynx is the ultimate site of fine control over pulse timing (Suthers and Fattu, 1973), the generation of intense sound requires high subglottic pressure (Fattu and Suthers, 1981). In *Pteronotus parnellii*, the one-to-one relationship between vocalizations and activity in muscles of the lateral abdominal wall in more than 2000 repetitions suggests a plausible source for the force needed to generate subglottic pressure. Similar patterns of muscle activity have been recorded from expiratory muscles in singing canaries (Hartley, 1990), vocalizing squirrel monkeys (Jürgens and Schriever, 1991) and vocalizing humans (Marchal, 1988). In the short syllables of canary songs that are comparable in length to echolocative vocalizations produced by *P. parnellii*, myopotentials commence prior to syllable onset and terminate before syllable offset (Hartley, 1990). Likewise, activity of the obliquus internus and transversus abdominus muscles of squirrel monkeys demonstrated a one-to-one relationship with vocalizations and showed relationships comparable in timing to that described for canaries and our data.

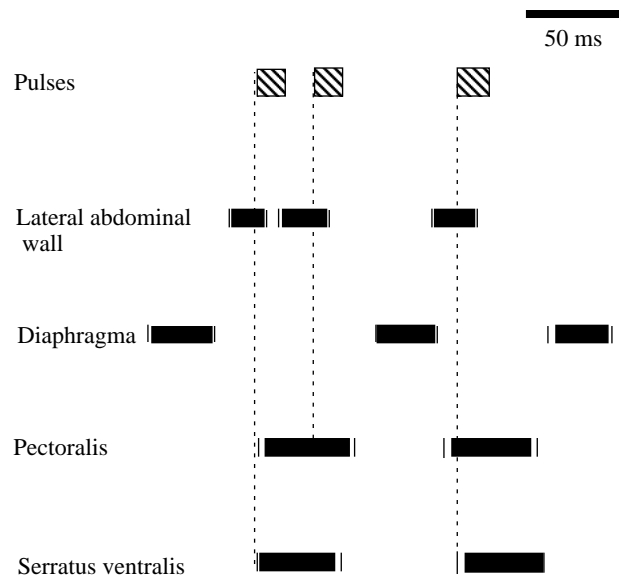

Fig. 19. Composite diagram depicting the relative timing characteristics of respiratory and flight muscle activities and biosonar vocalizations during flight. Error bars represent standard error of the mean.

The recognition that biosonar pulses are emitted in groups separated by distinct intervals led Grinnell and Griffin (1958) to suggest a correlation with the respiratory cycle. Our observation of the coincidence of myopotentials in the diaphragm with the intervals between pulse groups is consistent with their suggestion and with data of Suthers *et al.* (1972) and Suthers and Fattu (1973). It should be noted that these authors occasionally recorded vocalizations during inspirations, but these usually accompanied a simultaneous, brief reversal in air flow. Although integrated activity of the diaphragm and expiratory muscles can effectively control subglottic pressure, and thus sound pressure level, few studies link activity of the diaphragm to vocalization. The results reported for humans by Marchal (1988) are ambiguous in comparison with our data. He recorded peaks of activity between pronounced syllables, indicative of inspiratory activity. Other peaks, however, coincided with phonation. We saw no typical bursts from the diaphragm coincident with vocalization.

We interpret some unusually long myopotentials from the diaphragm as being related to augmented breaths (Fig. 15). These typically followed a succession of brief diaphragmatic myopotentials during a period of high-repetition-rate pulses. van Lunteren (1988) characterized an augmented breath as having a greater tidal volume and inspiratory time compared with typical breaths. This suggests that the normal, entrained respiratory cycle may be overridden for the production of vocalizations. The ensuing augmented breath may compensate for the temporary disruption.

Changes that occurred in patterns of muscle activity when bats ceased to vocalize illustrate functional differences in muscle activity between vocalization and quiet expiration. Since no consistent activity could be attributed to expiration in the absence of vocalization, elastic recoil of the lungs and body walls and pressure of the visceral mass on the diaphragm due to resting posture may provide some force to power quiet expiration. Recent studies on other mammals, however, emphasize the role of muscular activity in expiration, specifically by the transversus thoracis (triangularis sterni), and changes in patterns of muscle recruitment have been related to variations in posture (De Troyer and Ninane, 1986; van Lunteren, 1988; van Lunteren *et al.* 1988; Estenne *et al.* 1990; Farkas and Schroeder, 1993). The lack of activity in the abdominal wall during quiet expiration in *P. parnellii* suggests that alternative sources of force elevate pulmonary pressure and discharge air from the lungs.

We observed differences in diaphragmatic activity between times of vocalization and silence. There were shifts in the proportion of the respiratory cycle in which the diaphragm was active and changes in cycle duration. Diaphragmatic (inspiratory) myopotentials made up approximately one-quarter of the respiratory period during periods of vocalization, whether during flight or at rest. The remaining three-quarters of the respiratory cycle was expiratory. In the absence of vocalization, the respiratory period increased almost threefold, and the duration of activity in the diaphragm increased to

consume 71.5% of the cycle. Quiet expiration and vocalization are similar, in that both are associated with the expulsion of air from the lungs, but the muscle activities associated with the two processes differ dramatically, implying differences in energetic costs associated with them.

Some abdominal wall myopotentials occurred during periods of vocalization that could not be correlated with an individual pulse and were considered to represent brief, non-vocal expiratory events. These myopotentials followed a consistent pattern relative to duty cycle and pulse repetition rate. Expiratory myopotentials frequently appeared when agitated bats had elevated respiration rates, but a low to moderate pulse repetition rate compared with a quiet stationary bat. We hypothesize that these myopotentials represent muscular effort for the rapid completion of an expiration. These bursts retained the abrupt onset and termination characteristic of myopotentials that were accompanied by vocalizations. This is in contrast to the changes seen in bursts of the diaphragm between times of vocalization *versus* quiet rest and may indicate a difference in contractile properties of the muscles.

#### *Differences in muscle activity between flying and resting bats*

General patterns of respiratory muscle activity associated with vocalization (lateral abdominal wall and diaphragm) changed little from rest to flight. In the flying bat, however, myopotentials and pulses were significantly shorter in duration. In spite of this, the relationship between the onset of the myopotential and the pulse remained the same. In both situations, approximately 63% of the myopotential occurred prior to pulse onset and 37% overlapped the pulse.

For the diaphragm (Table 2), two trends are evident in the relationship between the flying and resting situations. First, as for the abdominal wall, myopotential durations are consistently longer at rest. Second, the durations of myopotentials and vocalizations in resting bats have a greater range of variation. This probably accounts for instances in Table 2 where the difference between flight and rest were insignificant. This great variation in data from bats at rest emphasizes the differing functions of the abdominal wall and diaphragm in vocalization and respiration. Abdominal wall activity relates to vocalization alone. Differences in timing relate to flight. At rest, in the absence of vocalization, activity virtually ceases and, therefore, imparts no variation to the timing patterns associated with respiration. Diaphragmatic activity, however, must adapt to both respiration and vocalization. Little variation is seen in flight when vocalization is continuous. The great range of variation of diaphragmatic activity at rest reflects the changes in activity associated with periods without vocalization. This dichotomy suggests greater functional plasticity in the diaphragm than in the abdominal wall. The diaphragm can react to a variety of respiratory situations from high-repetition-rate vocalization to the quiet respiration of sleep. The abdominal wall appears only to function in vocalization or forceful expiration; some other mechanism must be responsible for quiet expiration.

*Integration of vocalization and locomotion*

Mammals and birds accomplish feats of aerobic activity by virtue of locomotor and respiratory systems that work in concert, with a synergistic result (Berger *et al.* 1970; Bramble and Carrier, 1983; Bramble and Jenkins, 1993). Wingbeat and respiration consistently synchronize one-to-one in five species of bats ranging from 100 to over 800 g (Carpenter, 1986). Coordination of wingbeat and biosonar emissions has also been established in several bat species (Schnitzler, 1971; Suthers *et al.* 1972; Joermann and Schmidt, 1981). Previous studies have not, however, directly recorded the activity of respiratory muscles in flying bats. Our data extend existing evidence for locomotor-respiratory integration in flying bats by the addition of vocalization.

In this study, patterns of biosonar vocalization in flight provide a means of cross-correlating individually recorded muscle activity sequences among different flights and animals to yield a composite depiction of respiratory muscle coordination (Fig. 19). Abdominal wall myopotentials, which precede single pulses or the first pulse in a series, begin at or near the onset of the pectoralis and serratus ventralis activity. Bursts associated with second pulses begin during the last half of the muscular activity that powers the downstroke of the wings. The diaphragm becomes active after myopotentials of the flight muscles cease, occupying the interval between groups of vocalizations.

To infer the relationship between vocalizations and wingbeat, we compared our data with those of Hermanson and Altenbach (1981, 1983, 1985). The pectoralis and serratus ventralis, the major muscles of downstroke, begin firing from half to two-thirds of the way through the upstroke. As the wings slow to a halt and change direction, activity in these muscles continues through the first half of the downstroke. The abdominal wall myopotential for the first pulse of a group typically occurs before or near the middle of the upstroke, at about the time that flight muscles begin to contract. A second myopotential follows near the middle or towards the end of the downstroke. The burst of the diaphragm begins late in the downstroke and continues beyond the downstroke/upstroke transition. These interpretations generally concur with the observations of previous investigators, with some differences. Suthers *et al.* (1972, p. 44) noted that *Phyllostomus hastatus* tends to emit pulses coincident with reversals in ventilatory air flow, 'the instant at which the wings were at their downward-most position'. Schnitzler (1971) and Joermann and Schmidt (1981) also reported a consistent occurrence of the first sound of a group at the beginning of the upstroke. Trends in these studies were not quantified and figures depict a degree of variation. Although the first vocalization of a respiratory cycle usually occurred early in the upstroke, they ranged from the upstroke/downstroke transition to near the end of the upstroke. It is unclear whether inconsistencies between our data and earlier works are significant or are due to differences in methodology. We consider the similarities to be more significant than the discrepancies in that the difference between averages amounts to less than one-eighth of a wingbeat cycle,

and we expect variation among species that use differing styles of echolocation.

Suthers *et al.* (1972) first recorded the relationship between wingbeat, respiratory air flow and vocalization in a flying bat. They reported a seemingly paradoxical correlation between inspiration and the power stroke of flight in *Phyllostomus hastatus*. The simultaneous occurrence of inspiration and a downstroke of the wings appeared to bring the action of the diaphragm into conflict with powerful flight muscles that attach to the thorax. Our data on the activity of the diaphragm, in conjunction with data on flight muscle activity (Hermanson and Altenbach, 1981, 1983, 1985), help to resolve this problem. Contractions of the diaphragm begin after the downstroke muscles cease to fire (Fig. 19), and patterns of electrical activity between them are therefore out of phase. Timing patterns of electromyograms do not, however, correspond with the development of peak forces of muscular contraction. Force generated by the pectoralis in a flying bird peaks shortly after the termination of the electromyographic trace (Biewener *et al.* 1992). If force production in the diaphragm also lags behind electrical activity, inspiration can occur during the downstroke without working against the wing adductors. Similarly, myopotentials associated with single calls or the first call of a group usually occurred prior to the onset of the pectoralis burst (Fig. 17). This is also a likely case of electromechanical delay. The peak forces of abdominal muscle contraction presumably lag behind the electrical burst and probably coincide with development of force in the pectoralis and serratus ventralis. We expect the patterns of force production to show phase relationships similar to those for electrical activity, but electromyography alone cannot resolve this point.

It is important to recognize that coordination between vocalization and wingbeat is not obligatory. Our data and those of Suthers *et al.* (1972) illustrate that bats are able to produce vocalizations at any point during the wingbeat cycle. Entrainment does not constrain a bat's ability to emit signals and gather sensory information when it is needed. We observed asynchronous pulse production and wingbeat during landing, take-off and obstacle avoidance. These temporary disruptions in coordination were brief, however, and entrainment was promptly restored when rates of pulse repetition returned to lower levels.

Our data on the function of the abdominal wall are consistent with the accounts of previous authors. Suthers *et al.* (1972) reported observations suggesting that ventilatory movements were primarily associated with displacement of the abdominal rather than the thoracic wall. Schnitzler (1968) made similar observations, correlating flank movements with the emission of orientation pulses. It has been our observation that deeply anesthetized bats have a collapsed abdominal wall; when inspirations occur, the abdomen expands briefly and immediately collapses. These observations suggest that the abdominal wall, rather than the thoracic cage, generates the primary power for vocalization.

Changes in volume of the thorax and abdomen during

phonation in humans result mostly from movements of the rib cage and are largely due to action of the transversus thoracis (*triangularis sterni*) muscle (Estenne *et al.* 1990). The activity of this muscle closely follows phonation and is accompanied by simultaneous activation of abdominal muscles. Estenne *et al.* (1990) suggested that this coordinated activity serves to prevent the dissipation of pressure (or paradoxical expansion of the abdomen) that might accompany thoracic constriction alone. The subtle balance between pressure and volume of air during vocalization in bats appears to be under the control of the abdominal wall and diaphragm. Fig. 19 shows that these muscles adapt to the periodic loading placed on the thorax by the flight muscles by a facultative synchronization that may facilitate vocalization. In resting bats, however, we saw no facilitating activity in flight muscles accompanying vocalization. Passive thoracic compliance due to the rigid vertebral column and stiff attachment of ribs to vertebrae may be sufficient to counter dissipation of force generated by the abdominal wall. Alternatively, the activity of muscles from which we did not record may accompany abdominal activity. We did not attempt recordings from the transversus thoracis because of its small size and inaccessibility. However, the function of this muscle in respiration and vocalization in other mammals suggests that it has a similar role in bats.

#### *The economy of echolocation in flight*

The production of intense vocalizations can exact a substantial energetic cost (Ryan, 1988). Speakman *et al.* (1989) measured the cost of producing echolocative vocalizations by stationary pipistrelles. Their data, if extrapolated to flying animals, would attribute a significant proportion of total energy expenditure during flight to the production of biosonar pulses. In a continuation of that study, Speakman and Racey (1991) related the cost of vocalization to the total energetic cost of flight in echolocating bats. They plotted the logarithm of energetic cost of flight against the logarithm of mass in echolocating bats and in non-echolocating bats and birds. This graph revealed a linear relationship; in proportion to their size, echolocating bats expended no more energy in flight than did non-echolocating bats and birds. The costs incurred in the production of intense biosonar pulses in resting bats must be assimilated into the total cost of flight.

The energetic costs of vocalization are incurred by the force exerted by the abdominal and thoracic walls to pressurize a bolus of air and by the larynx to resist and control its release. The increased workload due to the elevated respiratory rate is probably also a factor. What could account for the great cost of vocalization at rest but not during flight? We hypothesize that the coincident occurrence of abdominal wall activity with the contraction of powerful flight muscles could substantially increase the force available to compress air in the lungs during flight (Figs 19, 20). By synchronizing pulse emission with wingbeat, bats appear to make double use of the force generated by the great muscles of downstroke: to power flight and to assist in the production of pressure for intense echolocative vocalizations.

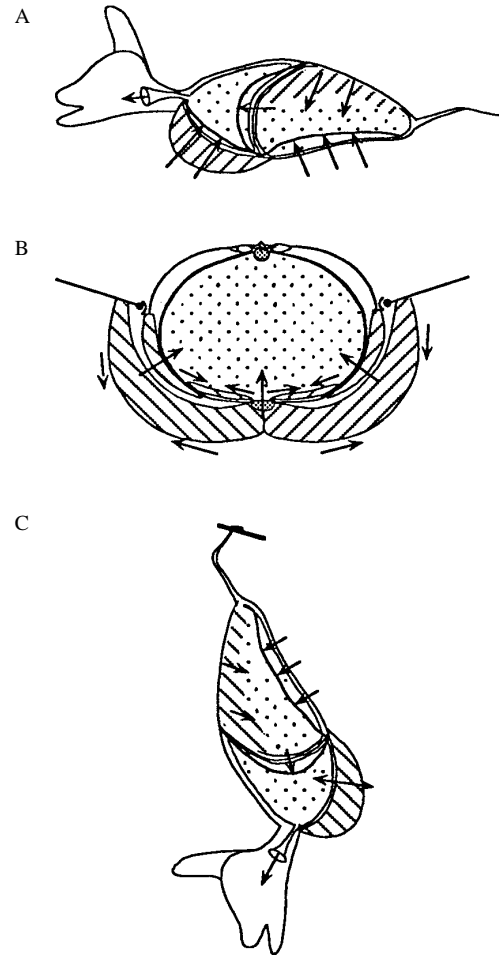

Fig. 20. Diagrams of a bat in parasagittal (A,C) and transverse (B) sections depicting the hypothetical forces of the lateral abdominal wall, the flight muscles and the transversus thoracis for the production of thoracoabdominal pressure for vocalization (arrows pointing inwards). In a flying bat (A), body cavities (stippling) are pressurized by simultaneous contractions of the lateral abdominal wall and the pectoralis (hatching) (*serratus ventralis* not shown). (B) The relationship between the transversus thoracis and pectoralis. The function of thoracic compression (arrows pointing inwards), which is supplemental to the primary function of flight muscles, could be borne by the transversus thoracis in a resting bat. In a stationary bat (C), contraction of the lateral abdominal wall in the absence of constraint on the thorax could dissipate pressure (outward-pointing arrow). Supplementary activity, perhaps by the transversus thoracis, could hinder this (inward-pointing arrow).

Our hypothesis of the dual use of thoracic muscle power for locomotion and thoracic compression accounts for the contribution made by the flight muscles to the energetics of echolocation. However, to achieve an energetic saving, some supplementary activity associated with vocalization in resting bats must desist or be rendered more efficient in flight. This supplementary activity must accompany vocalization at rest but be nonessential (or less demanding) for respiration.

Although we have demonstrated that the muscles of the lateral abdominal wall provide power for vocalization at rest and during flight, it appears that another agency, either passive or active, powers quiet expiration. Studies of other mammals show that quiet expiration is an active process, powered by the transversus thoracis (De Troyer and Ninane, 1986; van Lunteren, 1991). If this muscle functions in quiet respiration in bats as it does in other mammals, it could also act in conjunction with the abdominal wall muscles in building pressure for vocalization at rest. Estenne *et al.* (1990) demonstrated such a coordinated activity in human phonation. Alternatively, the increase in inspiratory frequency and inverted posture of bats could account for a component of the energetic cost of vocalization at rest. The diaphragm of a resting bat must elevate the visceral mass with each inspiration, whereas the horizontal orientation of flight alleviates the need to impel the viscera against gravity. This could explain the function of the relatively large pars lumbalis that we described in *P. parnellii*. Active components of vocalization at rest in addition to abdominal wall activity could contribute to the cost of echolocation.

The hypothesis must also account for variation in the propensity of different species to vocalize at rest. *Pteronotus parnellii* vocalize freely while stationary (Lancaster *et al.* 1992), as do species of *Rhinolophus*, *Hipposideros* (Link *et al.* 1986; Jones and Rayner, 1989) and *Tadarida* (Arlettaz, 1990). Roberts (1972, p. 445) recognized this behavior in *Rhinolophus luctus*, remarking that 'silent respiration was quite uncommon'. Conversely, Speakman *et al.* (1989) reported a reluctance of *Pipistrellus pipistrellus* to vocalize spontaneously during experiments. In two vespertilionids, *Eptesicus serotinus* and *Plecotus auritus*, sounds were obtained from a restrained animal with difficulty and were not produced in a continuous train (Roberts, 1972). Morphological differences may account for some of this variation.

The transversus thoracis of *P. parnellii* is a thin, delicate muscle, about 140  $\mu\text{m}$  thick (Fig. 7). This contrasts with that of *Lasiurus borealis* (a smaller bat than *P. parnellii*), in which the thickness (400  $\mu\text{m}$ ) and total size are similar to those of the lateral abdominal wall. It seems unlikely that an insubstantial transversus thoracis of *P. parnellii* could constrain the thorax in a resting bat that was emitting intense pulses. Conversely, the substantial muscle in *L. borealis*, if it is typical of vespertilionids, could serve as a plausible source of power to constrict the thorax in a resting bat and incur some energetic cost in doing so.

The thorax in some bats includes features that serve to increase rigidity. This is well illustrated in *Hipposideros commersoni*, in which thoracic rigidity is enhanced by broad, flat ribs, fusion of the ribs to the vertebrae, tight intervertebral articulations and fusion of the lumbar vertebrae (Vaughan, 1970a). We found similar features in *P. parnellii*, such as fusion of the lower thoracic and first lumbar vertebrae, little cranio-caudal rib angulation, and wedge-shaped capitula and costovertebral articulations (Fig. 3). In addition to anatomical similarities and comparable propensity towards vocalization at

rest, both *Hipposideros* and *Pteronotus* use relatively long, intense biosonar signals. Rigidity could help to constrain the thorax passively against the abdominal compression associated with the long, intense pulses used by these bats. The thorax of *Lasiurus* lacks features that appear to enhance rigidity. These differences may affect efficiency of vocalization in resting bats.

In conclusion, we propose that contractions of the lateral abdominal wall provide the primary pressurization for the production of intense biosonar vocalization during flying and in stationary bats. During flight, synchronization of vocalization with the activity of the pectoralis and serratus ventralis cooperate in pressurization of the thoraco-abdominal cavity. This utilization of pressure that is normally generated in the course of flight facilitates respiration and allows production of intense vocalizations with little additional energetic expenditure. Without the synchronous activity of flight muscles, bats at rest must resist a paradoxical thoracic expansion that could result from powerful contractions of the abdominal wall alone. For bats such as *L. borealis*, and perhaps other vespertilionids, this could be accomplished by simultaneous contractions of a powerful transversus thoracis, adding an energetic cost not incurred in flight. In bats such as *P. parnellii* that vocalize extensively at rest, thoracic stabilization might depend less on the weakly developed transversus thoracis, relying instead on a stiff thoracic cage as a passive means of counteracting inopportune thoracic expansion.

This work was supported by PHS grant DC00114 to O.W.H. Jr from the National Institute on Deafness and Other Communicative Disorders. We gratefully acknowledge the advice of Dona Boggs, John Hermanson and Kenneth Dial on electromyographic techniques. Statistical analysis was performed by the Biometric Consulting Laboratory, University of North Carolina at Chapel Hill. Illustrations of dissections were prepared by Marion Blackburn. Miriam Henson and two anonymous reviewers made valuable comments on the manuscript.

## References

- ALEXANDER, R. MCN. (1989). On the synchronization of breathing with running in wallabies (*Macropus* spp.) and horses (*Equus caballus*). *J. Zool., Lond.* **218**, 69–85.
- ARLETTAZ, R. (1990). Contribution à l'éco-éthologie du Molosse de Cestoni, *Tadarida teniotis* (Chiroptera), dans les Alpes valaisannes (sud-ouest de la Suisse). *Z. Säugetier.* **55**, 28–42.
- BERGER, M., ROY, O. Z. AND HART, J. S. (1970). The co-ordination between respiration and wing beats in birds. *Z. vergl. Physiol.* **66**, 190–200.
- BIEWENER, A. A., DIAL, K. P. AND GOSLOW, G. E., JR (1992). Pectoralis muscle force and power output during flight in the starling. *J. exp. Biol.* **164**, 1–18.
- BRAMBLE, D. M. AND CARRIER, D. R. (1983). Running and breathing in mammals. *Science* **219**, 251–256.
- BRAMBLE, D. M. AND JENKINS, F. A., JR (1993). Mammalian locomotor-respiratory integration: implications for diaphragmatic and pulmonary design. *Science* **262**, 235–240.



- CARPENTER, R. E. (1986). Flight physiology of intermediate-sized fruit bats (Pteropodidae). *J. exp. Biol.* **120**, 79–103.
- CARRIER, D. R. (1987). The evolution of locomotor stamina in tetrapods: circumventing a mechanical constraint. *Paleobiology* **13**, 326–341.
- DE TROYER, A., KELLY, S., MACKLEM, P. T. AND ZIN, W. A. (1985). Mechanics of intercostal space and actions of external and internal intercostal muscles. *J. clin. Invest.* **75**, 850–857.
- DE TROYER, A. AND NINANE, V. (1986). Triangularis sterni: a primary muscle of breathing in the dog. *J. appl. Physiol.* **60**, 14–21.
- DIAL, K. P., GOSLOW, G. E. AND JENKINS, F. A., JR (1991). The functional anatomy of the shoulder in the European starling (*Sturnus vulgaris*). *J. Morph.* **207**, 327–344.
- ESTENNE, M., ZOCCHI, L., WARD, M. AND MACKLEM, P. T. (1990). Chest wall motion and expiratory muscle use during phonation in normal humans. *J. appl. Physiol.* **68**, 2075–2082.
- FARKAS, G. A. AND SCHROEDER, M. A. (1993). Functional significance of expiratory muscles during spontaneous breathing in anesthetized dogs. *J. appl. Physiol.* **74**, 238–244.
- FATTU, J. M. AND SUTHERS, R. A. (1981). Subglottic pressure and the control of phonation by the echolocating bat, *Eptesicus*. *J. comp. Physiol.* **143**, 465–475.
- GRIFFIN, D. R., WEBSTER, F. A. AND MICHAEL, C. R. (1960). The echolocation of flying insects by bats. *Anim. Behav.* **8**, 141–154.
- GRIFFITHS, T. A. (1983). Comparative laryngeal anatomy of the big brown bat, *Eptesicus fuscus* and the mustached bat, *Pteronotus parnellii*. *Mammalia* **47**, 377–394.
- GRINNELL, A. D. AND GRIFFIN, D. R. (1958). The sensitivity of echolocation in bats. *Biol. Bull. mar. biol. Lab., Woods Hole* **114**, 10–22.
- HARTLEY, R. S. (1990). Expiratory muscle activity during song production in the canary. *Respir. Physiol.* **81**, 177–188.
- HENSON, O. W., JR, BISHOP, A., KEATING, A., KOBLER, J., HENSON, M., WILSON, B. AND HANSEN, R. (1987). Biosonar imaging of insects by *Pteronotus p. parnellii*, the mustached bat. *Nat. geog. Res.* **3**, 82–101.
- HERMANSON, J. W. AND ALTENBACH, J. S. (1981). Functional anatomy of the primary downstroke muscles in the pallid bat, *Antrozous pallidus*. *J. Mammal.* **62**, 795–800.
- HERMANSON, J. W. AND ALTENBACH, J. S. (1983). The functional anatomy of the shoulder of the pallid bat, *Antrozous pallidus*. *J. Mammal.* **64**, 62–75.
- HERMANSON, J. W. AND ALTENBACH, J. S. (1985). Functional anatomy of the shoulder and arm of the fruit-eating bat *Artibeus jamaicensis*. *J. Zool., Lond.* **205**, 157–177.
- JENKINS, D. B. (1991). *Hollinshead's Functional Anatomy of the Limbs and Back*, 6th edn, 397pp. Philadelphia: W. B. Saunders Co.
- JOERMANN, G. AND SCHMIDT, U. (1981). Echoortung bei der Vampirfledermaus, *Desmodus rotundus*. II. Lautaussendung im Flug und Korrelation zum Flügelschlag. *Z. Säugetier.* **46**, 136–145.
- JONES, G. AND RAYNER, J. M. V. (1989). Foraging behavior and echolocation of wild horseshoe bats *Rhinolophus ferrumequinum* and *R. hipposideros* (Chiroptera, Rhinolophidae). *Behav. Ecol. Sociobiol.* **25**, 183–191.
- JÜRGENS, U. AND SCHRIEVER, S. (1991). Respiratory muscle activity during vocalization in the squirrel monkey. *Folia primatol.* **56**, 121–132.
- KANWAL, J. S., MATSUMURA, S. AND SUGA, N. (1992). Properties of communication sounds of the mustached bat. *Abstracts of the 15th Midwinter Meeting of the Association for Research in Otolaryngology*, p. 143.
- LANCASTER, W. C., KEATING, A. W. AND HENSON, O. W., JR (1992). Ultrasonic vocalizations of flying bats monitored by radiotelemetry. *J. exp. Biol.* **173**, 43–58.
- LINK, A., MARIMUTHU, G. AND NEUWEILER, G. (1986). Movement as a specific stimulus for prey catching behavior in rhinolophid and hipposiderid bats. *J. comp. Physiol. A* **159**, 403–413.
- LOEB, G. E. AND GANS, C. (1986). *Electromyography for Experimentalists*, 373pp. Chicago: University of Chicago Press.
- MACALISTER, A. (1872). The myology of the Chiroptera. *Phil. Trans. R. Soc. Lond.* **162**, 125–171.
- MARCHAL, A. (1988). Contrôle de la respiration dans la parole. *Folia phoniat.* **40**, 1–11.
- MARSH, R. L. AND TAIGEN, T. L. (1987). Properties enhancing aerobic capacity of calling muscles in gray tree frogs, *Hyla versicolor*. *Am. J. Physiol.* **252**, R786–R793.
- MORI, M. (1960). Muskulature des *Pteropus edulis*. *Okijamas Fol. Anat. Japan* **36**, 253–307.
- NOMINA ANATOMICA VETERINARIA, (1983). Third edition, International Committee on Veterinary Anatomical Nomenclature: Mexico City.
- ROBERTS, L. H. (1972). Correlation of respiration and ultrasound production in rodents and bats. *J. Zool., Lond.* **168**, 439–449.
- ROBIN, H. A. (1881). Recherches anatomiques sur les mammifères de l'ordre des chiroptères. *Librairie de l'Académie de Médecine (Paris) Serie A*, **45**, 1–180.
- RYAN, M. J. (1988). Energy, calling and selection. *Am. Zool.* **28**, 885–898.
- SCHNITZLER, H.-U. (1968). Die Ultraschall-Ortungslaute der Hufeisen-Fledermäuse (Chiroptera-Rhinolophidae) in verschiedenen Orientierungssituationen. *Z. vergl. Physiol.* **57**, 376–408.
- SCHNITZLER, H.-U. (1971). Fledermäuse im Windkanal. *Z. vergl. Physiol.* **73**, 209–221.
- SPEAKMAN, J. R., ANDERSON, M. E. AND RACEY, P. A. (1989). The energy cost of echolocation in pipistrelle bats (*Pipistrellus pipistrellus*). *J. comp. Physiol. A* **165**, 679–685.
- SPEAKMAN, J. R. AND RACEY, P. A. (1991). No cost of echolocation for bats in flight. *Nature* **350**, 421–423.
- SUTHERS, R. A. AND FATTU, J. M. (1973). Mechanisms of sound production by echolocating bats. *Am. Zool.* **13**, 1215–1226.
- SUTHERS, R. A., THOMAS, S. P. AND SUTHERS, B. J. (1972). Respiration, wing-beat and ultrasonic pulse emission in an echolocating bat. *J. exp. Biol.* **56**, 37–48.
- VAN LUNTEREN, E. (1988). Respiratory muscle coordination. *J. Lab. clin. Med.* **112**, 285–300.
- VAN LUNTEREN, E. (1991). Contractile and endurance properties of the feline triangularis sterni muscle. *Respir. Physiol.* **85**, 279–287.
- VAN LUNTEREN, E., HAXHUI, M. A., CHERNIACK, N. S. AND ARNOLD, J. S. (1988). Rib cage and abdominal expiratory muscle responses to CO<sub>2</sub> and esophageal distension. *J. appl. Physiol.* **64**, 846–853.
- VAUGHAN, T. A. (1959). Functional morphology of three bats: *Eumops*, *Myotis* and *Macrotus*. *Univ. Kansas Pubs, Mus. nat. Hist.* **12**, 1–153.
- VAUGHAN, T. A. (1970a). The skeletal system. In *Biology of Bats*, vol. 1 (ed. W. A. Wimsatt), pp. 98–139. New York: Academic Press.
- VAUGHAN, T. A. (1970b). The muscular system. In *Biology of Bats*, vol. 1 (ed. W. A. Wimsatt), pp. 140–194. New York: Academic Press.