

## MECHANISM AND POSSIBLE BEHAVIOURAL RELEVANCE OF RETINAL MOVEMENTS IN THE CTENID SPIDER *CUPIENNIUS SALEI*

FLORIAN KAPS\* AND AXEL SCHMID

*Biologiezentrum, Institut für Zoologie, Universität Wien, Althanstr. 14, 1090 Wien, Austria*

*Accepted 1 August 1996*

### Summary

Like most spiders, the nocturnal hunting spider *Cupiennius salei* is able to move the retinae of its antero-medial (AM) eyes. In the present study, the morphological and physiological properties of the eye muscles and the mechanism and behavioural relevance of retinal movements are investigated.

The retinal movements are brought about by two forces: (i) contractions of the dorsal and ventral eye muscles, and (ii) the passive elastic restoring force of the eye tube and eye muscles (the presumed counteracting force). The dorsal eye muscle consists of 15–18 striated fibres and is 600  $\mu\text{m}$  long. The ventral eye muscle is longer (650  $\mu\text{m}$ ) and consists of 20–22 striated fibres.

The direction of the gaze of the retinae brought about by the eye muscles (active retinal movements) depends on the contraction states of the two eye muscles. The medially directed action of both eye muscles does not allow active movements of the eye tube in any lateral direction. Thus, the direction of gaze cannot actively be shifted medially. After active displacement of the retina, the elasticity of the eye tube and eye muscles passively moves the eye tube back to its resting position.

There are two types of retinal movements.

(i) *Spontaneous microsaccades* (duration 80ms; excursion 3°) are caused by the spontaneous contraction of only the dorsal eye muscle. They are ideally suited for preventing the adaptation of the sensory cells since their mean excursion (3°) perfectly fits the inter-receptor angle (2.9°) in the AM eye of *Cupiennius salei*. (ii) *Induced movements* (duration 100–500ms; excursions 4–15°) are caused by the contraction of both eye muscles and occur only after mechanical stimulation. Induced movements were elicited by stimulating the mechanosensory organs (trichobothria and slit sense organs) of the spider's legs. A stimulus on one side of the spider induces movements of the ipsilateral retina only. We therefore suggest that induced retinal movements are saccades shifting the gaze of the spider laterally towards the site of mechanical stimulation.

According to behavioural experiments, the ability of a spider to locate an immobile target is highly impaired after blinding its AM eyes. We suggest that the motility of the AM eyes is required to locate stationary objects.

Key words: spider, *Cupiennius salei*, retinal movement, antero-medial eyes, vision.

### Introduction

Like most other spiders, *Cupiennius salei* has eight eyes; two principal eyes (antero-medial, AM) in which the rhabdomeres of the receptor cells are orientated towards the light and six secondary eyes (antero-lateral, AL; postero-medial, PM; postero-lateral, PL) in which the rhabdomeres point towards a reflecting tapetum in the back of the eye tube.

The existence of eye muscles in spiders and the ability of these animals to move their AM eyes has been known since the last century (Brants, 1838; Leydig, 1855). The eye muscles are restricted to the two principal eyes. The retinae of the six secondary eyes cannot be moved (Grenacher, 1879; Bertkau, 1886). The number of eye muscles correlates with the spider's lifestyle: most web-building spiders possess only one dorsal muscle, whereas hunting spiders have at least two (Widmann,

1908). The main function of the eye muscles is to shift the retina by deforming the elastic eye tube (Demoll, 1917).

In contrast to our knowledge of the anatomy of spider eye muscles, little is known about the physiological basis and possible behavioural relevance of the retinal movements induced by them. Only the retinal movements of the jumping spiders (Salticidae) and their possible function have been described in detail (Land, 1969; Forster, 1985). In these spiders, six eye muscles not only shift the retinae of the AM eyes linearly, but also rotate them. Land (1969) found four types of retinal movements: (i) spontaneous activity; (ii) saccades, which fixate the fovea of the AM eye on a particular target; (iii) tracking, which keeps a fixated moving target on the fovea; and (iv) scanning, an oscillatory side-to-side

movement combined with rotation. It was suggested that scanning is involved in pattern recognition.

Recent studies on the quality of the optical image and retinal resolution as well as on the sensitivity of the eyes of *C. salei* (Land and Barth, 1992; Barth *et al.* 1993) have shown that in this hunting spider the quality of vision is likely to be much better than had been expected ( $f$ -number 0.58–0.74; inter-receptor angle 0.9–9.3°; sensitivity threshold 0.01lx). The retinal movements of *C. salei* are presumed not to be as differentiated as in salticids, however (Land and Barth, 1992).

In the present paper, we describe the generation of retinal movements in *C. salei* by comparing eye-muscle electromyograms with the resulting retinal movements. We also provide evidence that retinal movements might be used to prevent visual adaptation, allowing the detection of stationary targets, and that the visual fields of the AM eyes are shifted towards sites of mechanical stimulation of the legs.

### Materials and methods

In all experiments, we used adult female *Cupiennius salei* Keys aged 9–13 months. The animals, reared in our Institute, were kept individually in glass jars and fed once per week on flies and cockroaches. The temperature (22–28°C), light and humidity (80–95%) regime resembled natural conditions.

#### Anatomy

The structure of the eye muscles was studied in three ways: (i) observation of alcohol-fixed whole-mount preparations of animals, (ii) light microscopic observations on serial histological sections, and (iii) scanning electron microscope investigations on the opened prosoma. For light microscopy, the prosoma of the spider was fixed in Bouin's solution for 2 days, washed in 70% alcohol (3–4 days), dehydrated in an ethanol series and embedded in paraffin. Sections (10 µm) were cut on a rotation microtome. The sections were stained following the Azan procedure according to Heidenhain (Romeis, 1989). *Camera lucida* drawings and photographs were used to reconstruct the eye muscles. For scanning electron microscopy, after fixing, washing, dehydrating and embedding the prosoma in paraffin, a surface of intersection was cut just posterior to the AM eyes. The paraffin was then dissolved in xylene for 1 day. The preparation was cleaned in acetone, critical-point dried, sputtered with gold and observed and photographed with a scanning electron microscope (35CF/JEOL).

#### Electrophysiology

The spider was anaesthetized by chilling at 5°C for approximately 50 min and was then mounted onto a holder. To record from the eye muscles, electrolytically tapered tungsten electrodes (diameter 0.2 mm) were inserted through the frontal region of the prosoma. An earthed reference electrode was placed into the opisthosoma. Retinal movements were recorded simultaneously with the muscle activity using a video camera (50 frames s<sup>-1</sup>). With reference to clearly visible retinal landmarks on the AM eyes, frame-by-frame analysis of the video recordings allowed an exact calculation of the extent and

direction of retinal displacement. These measurements could be subsequently correlated with the simultaneously recorded muscle activity.

Induced retinal movements were evoked by stimulating the trichobothria and slit sense organs of the tarsal region of the spider's legs using a short (0.7–0.8 s) air pulse (velocity 7–14 m s<sup>-1</sup>) (Fig. 1). During these experiments, all the eyes of the animal were covered with black varnish to exclude any visual stimulation. The direction and amplitude of the elicited retinal movements were assessed by analyzing the electromyograms of the eye muscles.

#### Behaviour

Behavioural experiments were carried out at a light intensity of 200 lx in an isolated room in a 2.5 m × 2.5 m arena. The floor and walls of the arena were homogeneously coloured bright yellow up to a height of 2.5 m and the release site was covered by a curtain of the same colour up to a height of 0.8 m. The animals had either the AM eyes covered with black varnish and the other three pairs of eyes untreated, or *vice versa*. In control experiments, all eyes were untreated. The animals were released at a distance of 2 m from a target, which was a black cardboard stripe (width 0.24 m, height 0.5 m). A glass jar containing the animal was placed at the starting point and the animal was carefully driven to leave the jar at the side facing the target. Its walking path was schematically noted and the number of successful trials (i.e. those in which the animals reached the target) was counted. The experiment was stopped if an animal reached the wall and started to climb up. We used

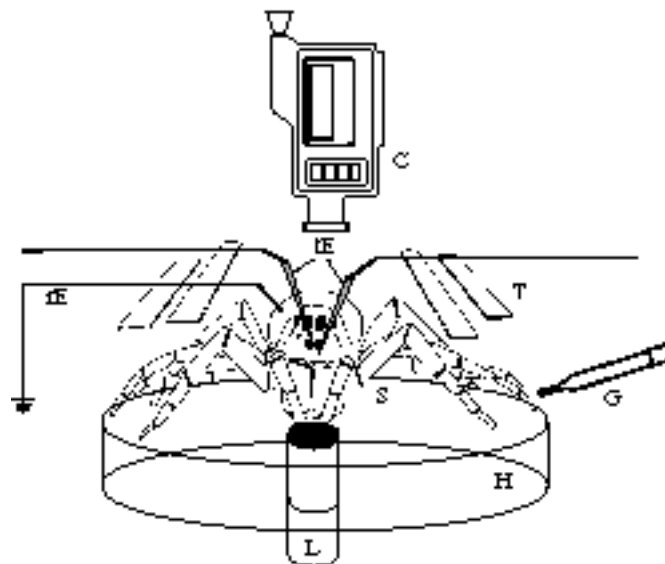

Fig. 1. Experimental arrangement used for the electrophysiological recordings. The spider (S) was fixed with tape (T) onto a holder (H). The activities of the eye muscles were recorded using two tungsten electrodes (tE). An earthed reference electrode (rE) was placed into the opisthosoma. In order to record the retinal movements of the antero-median (AM) eyes with a video camera (C), the spider was illuminated *via* a light guide (L) from below. A pipette-directed pulse of air (G) was used for mechanical stimulation.

18 animals, six in each of three groups: (i) all secondary eyes covered, (ii) AM eyes covered, (iii) no eyes covered. The treated animals were tested 20 times and the untreated animals four times (control experiment).

## Results

### Anatomy of the eye muscles

The AM eyes of *Cupiennius salei* have two small eye muscles each, a dorsal and a ventral one (Fig. 2). The dorsal

eye muscle arises dorso-laterally on the AM eye tube and attaches to the dorso-median carapace between the postero-median (PM) eyes. It is 600  $\mu\text{m}$  long and consists of 15–18 striated fibres. It varies in breadth from 50  $\mu\text{m}$  at its dorsal insertion point to 300  $\mu\text{m}$  in the ventral region in which the fibres fan out and insert onto the eye tube.

The ventral eye muscle consists of 20–22 striated fibres and is 650  $\mu\text{m}$  long. It is attached to the ventro-lateral surface of the eye tube and inserts at the carapace on the ventral internal surface of the clypei. It is 75  $\mu\text{m}$  wide at its ventral insertion

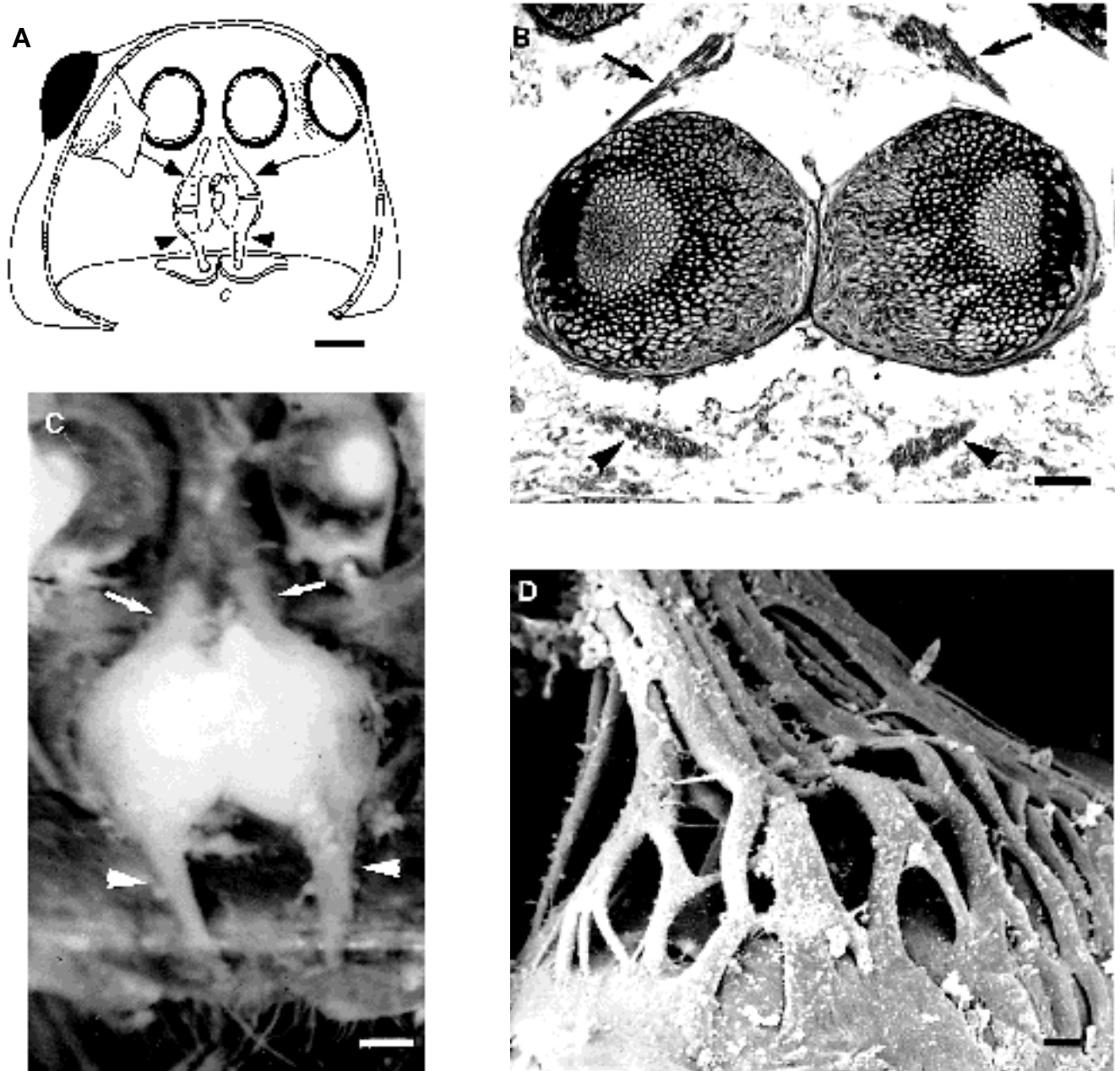

Fig. 2. Structure and course of the eye muscles of *Cupiennius salei*. (A) Schematic rear view of the frontal side of the prosoma. Arrows indicate the dorsal eye muscles, arrowheads the ventral eye muscles. *c*, clypei; scale bar, 500  $\mu\text{m}$ . (B) Frontal section through the region of the antero-median (AM) eyes showing the AM eye tubes, the dorsal eye muscles (arrows) and the ventral eye muscles (arrowheads); scale bar, 200  $\mu\text{m}$ . (C) Photograph of an opened prosoma showing the same structures as in A. The white arrows and arrowheads mark the dorsal and ventral eye muscles. Scale bar, 100  $\mu\text{m}$ . (D) Scanning electron micrograph of the dorsal eye muscle where it inserts onto the AM eye tube. Scale bar, 20  $\mu\text{m}$ .

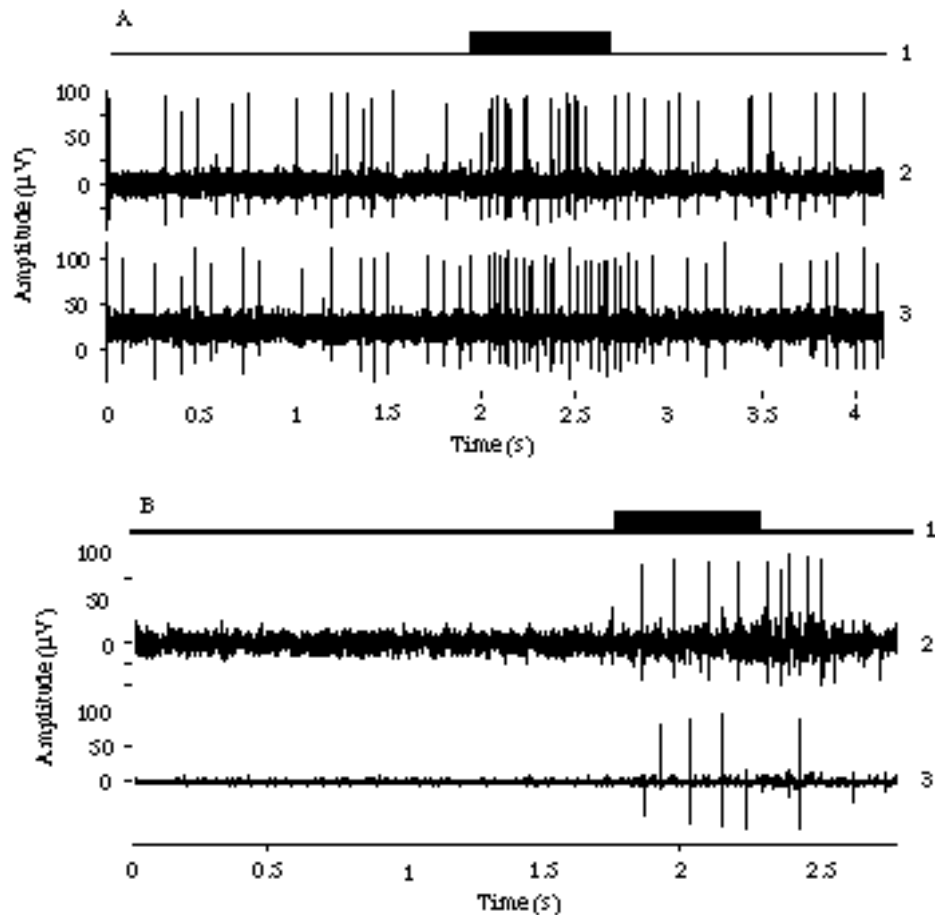

Fig. 3. Extracellular recordings from the two dorsal eye muscles (A) and the two ventral eye muscles (B). (A) The dorsal eye muscles are spontaneously active (traces 2 and 3). Mechanical stimulation of the legs using a puff of air (bar in trace 1) increases the discharge frequency. (B) The ventral eye muscles are not spontaneously active; activity can only be detected during and after mechanical stimulation.

point and widens to  $300\ \mu\text{m}$  at the insertion area on the eye tube.

#### *Physiological properties of the eye muscles*

Extracellularly recorded spikes had an amplitude of  $50\text{--}150\ \mu\text{V}$  for both eye muscles and varied in duration from 2 to 3 ms. The activity patterns of the dorsal and ventral eye muscles were completely different (Fig. 3). The dorsal eye muscles are spontaneously active, with a mean resting frequency of  $12\pm 1\ \text{Hz}$  (mean  $\pm$  s.d.; 20 recordings from six animals). After mechanical stimulation (air puff on the leg), this frequency increases to 80 Hz. The ventral eye muscles are not spontaneously active and action potentials can only be elicited by mechanical stimulation. Following mechanical stimulation, their frequency (up to 80 Hz) depends on the modality and intensity of the stimulus.

#### *Active retinal movements*

According to electromyograms recorded simultaneously from the two dorsal or ventral eye muscles of both AM eyes, the muscles of the two AM eyes are not active synchronously. Video recordings of the retinal movements also showed that neither the occurrence nor the direction of the movements of both eyes are correlated.

Two kinds of retinal movements can be distinguished.

(i) Spontaneous microsaccades continuously 'vibrate' the retinae of unstimulated spiders. These short (80 ms), 'jerky' retinal movements are produced by the dorsal eye muscle only. Every spike in the eye muscle causes one microsaccade. Therefore, the frequency of the microsaccades corresponds to the resting discharge frequency of the dorsal eye muscle. Excursions made by the retina during this kind of activity measure approximately  $2\text{--}4^\circ$  in the dorso-medial direction. Retinal movement is always accompanied by a corresponding shift of the visual field in the opposite direction (Fig. 4). Therefore, a spontaneous microsaccade shifts the visual field in a ventral direction, whereupon passive forces bring it back to its resting position. (ii) Induced movements of the retina can be elicited by mechanical stimulation (air puff to the leg). The contractions of both the dorsal and ventral eye muscles cause a displacement of the retina by up to  $15^\circ$ . Since the direction of these excursions depends on the extent of contraction of both eye muscles (Fig. 5), it can be calculated by comparing the discharge rates taken from electromyograms of the two muscles. In order to take the influence of the spontaneous microsaccades into account, the spontaneous discharge rate of the dorsal eye muscle must be subtracted from its stimulus-evoked rate. The ventral eye muscle has no spontaneous activity and therefore its measured activity (stimulus-induced discharge rate) can be used directly to calculate the direction

Fig. 4. The visual fields of the antero-median eyes of *C. salei* (based upon the description of Land and Barth, 1992) can be projected onto a globe with its central point between the clypei of the spider. The black arrows indicate the direction and the extent of the visual field shifts caused by active retinal movements. The shaded arrows indicate the passive retraction. (A) Spontaneous microsaccades shift the visual fields in a ventral direction. (B) Induced movements can shift the visual fields in a dorso-lateral (1), lateral (2) or ventro-lateral (3) direction.

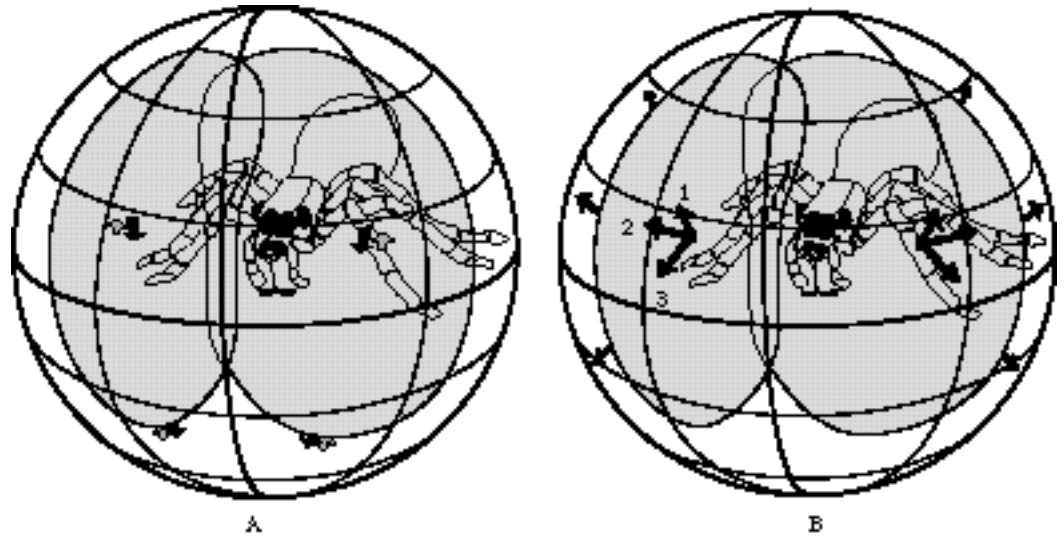

of the induced movements. The possible shifts of the visual field of the AM eye are therefore in the lateral, dorso-lateral and ventro-lateral directions.

If the change in activity ( $\delta f$ ) of the dorsal eye muscle is as large as the measured discharge frequency ( $f$ ) of the ventral eye muscle ( $\delta f - f = 0$ ), the retina moves in a medial direction ( $=0^\circ$ ). If the change in activity of the dorsal eye muscle is greater than the discharge frequency of the ventral muscle activities ( $\delta f - f > 0$ ), a more dorsal retinal movement results. The larger the value of  $\delta f - f$ , the more dorsal is the resulting induced retinal movement. If the activity of the ventral eye muscle is greater than that of the dorsal eye muscle ( $\delta f - f < 0$ ), the retinal movements will be directed ventrally (Fig. 6).

#### Passive retinal movements

After every spontaneous microsaccade, the retina is returned to its resting position by elastic forces within the distorted eye tube and the stretched ventral eye muscle. The result is a characteristic up-and-down movement of the retina (see Fig. 4). This movement disappears after cutting either the dorsal or the ventral eye muscle.

During induced eye movements, the elasticity of the eye tube and the passively deformed eye muscles counteract the forces produced by the eye muscles just as described for the spontaneous microsaccades. After cutting a dorsal eye muscle, the spider can still move the retina following mechanical stimulation of the leg, but only in a ventral direction. However, this spider loses its ability to bring the eye tube back into its resting position.

#### Retinal movements following mechanical stimulation

As noted above, short air pulses applied to the trichobothria and slit sense organs of the tarsi of the second pair of legs of the spider elicited retinal movements. There was a strong correlation between the side of the mechanical stimulus and the side of the responding eye muscle (Fig. 7). After receiving an air pulse on the right leg, all animals tested (40 recordings

from six animals) contracted only their right ventral eye muscle, thereby shifting the visual field of their right AM eye to the right side, i.e. towards the stimulus. Stimulation of the left leg induced retinal movement of only the left eye.

As a control, all mechanoreceptors of the legs (trichobothria and slit sensilla) were covered using varnish and Parafilm, abolishing or decreasing their sensitivity. In these animals ( $N=4$ ), the air pulses did not cause any retinal movement.

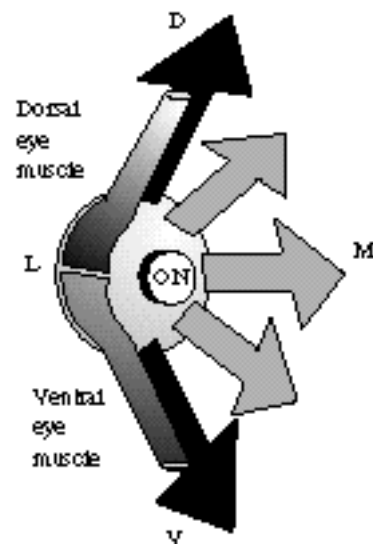

Fig. 5. Arrangement of the eye muscles. The eye tube is shown in posterior view with the optical nerve (ON) cut. The black arrows indicate the directions of the forces produced by the two different eye muscles. If only the dorsal or ventral eye muscle contracts, the eye tube is deflected in the direction of the upper or lower black arrow respectively. If both eye muscles contract simultaneously, the retina is shifted in a direction determined by the vector sum of the forces generated by them. The grey arrows are examples of possible movement directions. D, dorsal; M, medial; V, ventral; L, lateral.

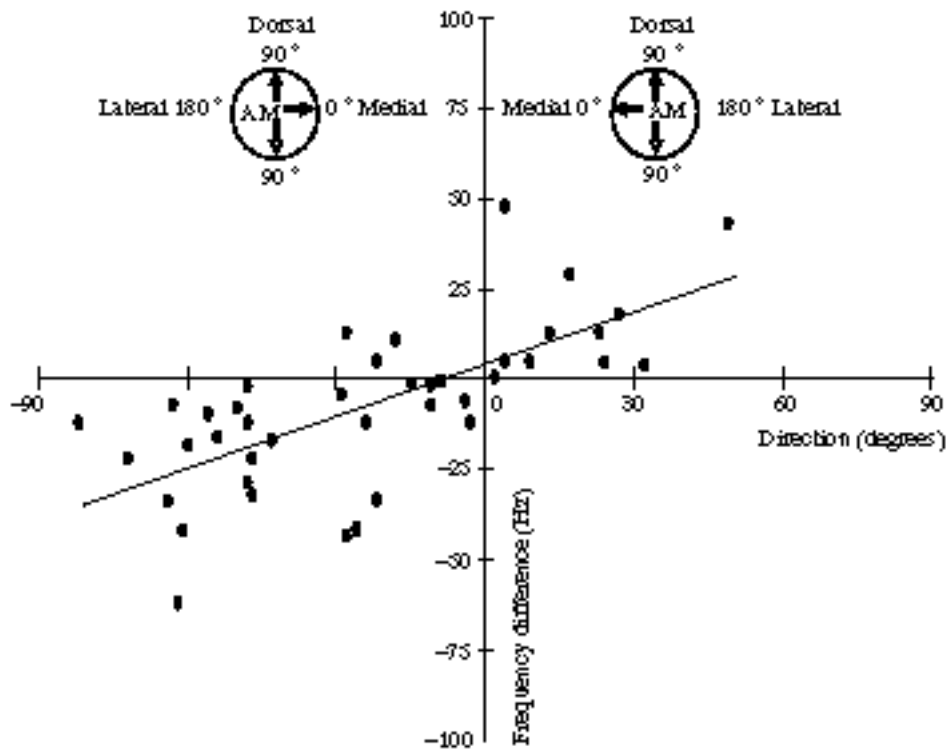

Fig. 6. Correlation between the direction of retinal movements (plotted on the  $x$ -axis) and the difference in activity between the eye muscles  $\delta f - f$ , where  $\delta f$  is the change in EMG activity of the dorsal eye muscle due to mechanical stimulation and  $f$  is the activity of the ventral eye muscle due to stimulation. The differences in spike frequencies are plotted in Hz. The measured direction of retinal movements is shown on the  $x$ -axis.  $0^\circ$  corresponds to a movement in the medial direction,  $90^\circ$  in a dorsal direction (as shown in the insets).

#### Visually guided behaviour

We measured the ability of the animals to walk towards a black target using three different treatments to determine how the different eye types might be involved in a simple behavioural task. According to Land (1985), it is likely that the principal (AM) and secondary eyes of hunting spiders have different roles in the animal's behaviour. To examine this, we focused our interest mainly on the the AM and PM eyes, because they have almost completely overlapping visual fields.

In the control experiments, all six animals tested walked towards the target in at least three of the four runs. In 87.5% of the tests, the animals reached the target. The ratio of successful to failed runs was 21:3. In the case of the failed runs, the animals never approached the target. With the AM eyes untouched and all other eyes covered with black varnish, 65.8% of the animals reached the target. The ratio of successful to failed trials was 79:41. When the AM eyes were covered but all other eyes were left untouched (six animals were tested 120 times in total, i.e. 20 runs each), only 25.8% of the animals reached the target. The ratio of successful to failed trials was 31:89. The differences between treatments were significant ( $P < 0.01$ , two-sided sign test). The ability to detect a target is highly significantly impaired when the AM eyes are blinded ( $\chi^2$ -test,  $P < 0.001$ ).

#### Discussion

The striated eye muscles of *Cupiennius salei* are similar to those described for *Lycosa polioostoma* and *Lycosa travassosi* (number of striated fibres in eye muscles of *C. salei*: dorsal 15–18, ventral 20–22; *L. polioostoma*: dorsal 15, ventral 25; Melamed and Trujillo-Cenóz, 1971). In contrast, in

*Metaphidippus aeneolus* (Salticidae; Land, 1969), both the number of muscles (six) and their arrangement on both sides of the eye tube differ from those of *C. salei*.

Both dorsal and ventral eye muscles of *Cupiennius salei* insert laterally on the eye tube (Fig. 2). Therefore, all movements of the retinae produced by the two muscles always include a medial component. Accordingly, the slightly overlapping visual fields of the AM eyes (Land and Barth, 1992) can never be shifted medially to enlarge the binocular visual fields. Another property of this muscle arrangement is that the dorsal and ventral eye muscles can work synergistically. When both muscles contract simultaneously (induced retinal movements), the retina is moved in the direction of the vector sum of the forces generated by them.

The first suggestions concerning the behavioural roles of eye movements in *C. salei* were made by Land and Barth (1992). They speculated that the spontaneous microsaccades will prevent the neural image in the AM eyes from adapting. Therefore, they anticipated that, as in salticids (Land, 1969), the function of the AM eyes is to examine stationary objects, whereas the unmovable secondary eyes (which do adapt) serve to detect motion.

The results of our experiments suggest that the spontaneous microsaccades (excursion  $2$ – $4^\circ$ ) are perfectly suited to prevent visual adaptation because they match the inter-receptor angle in the AM eye of approximately  $3^\circ$  (Land and Barth, 1992). Although we are not able to present any data to show that *C. salei* can perceive stationary targets, a common strategy in various species (e.g. man) is to use small, frequent eye movements to prevent adaptation. We believe that this strategy might also be used by *Cupiennius salei*.

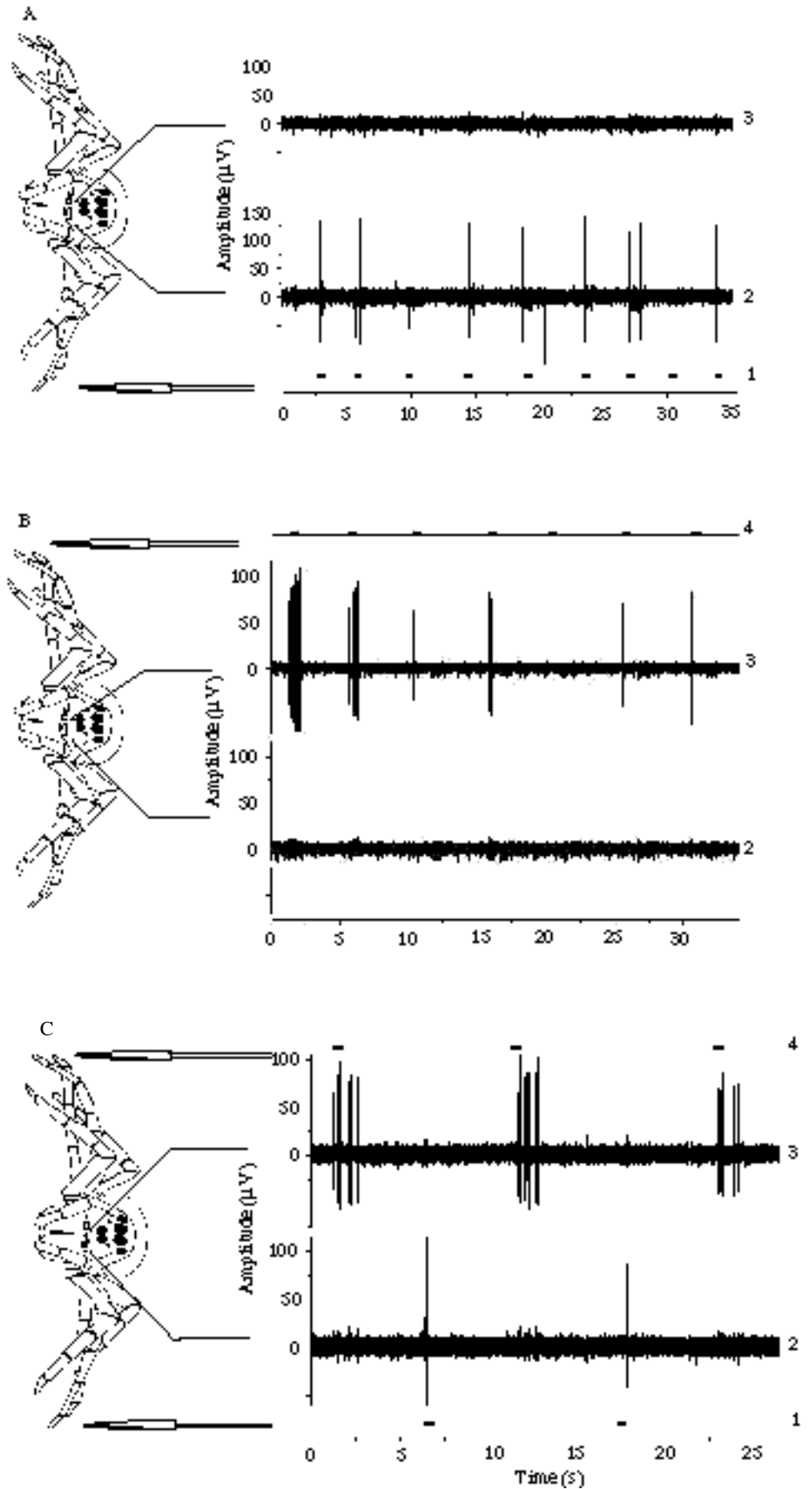

Fig. 7. Correlation between mechanical stimulus application to a right or left leg and the response of the ventral eye muscles. Traces 1 and 4 show the onsets of the left and right stimulation respectively, traces 2 and 3 show the corresponding electromyograms of the left and right ventral eye muscles. (A) stimuli to a left leg, (B) stimuli to a right leg and (C) alternating stimuli to each leg.

In its natural habitat, *Cupiennius salei* often spends hours without moving. There are three reasons for this behaviour: (i) the spider saves energy, (ii) it is almost invisible to its enemies, and (iii) it does not alert potential prey, even at close distances. In this motionless state, spontaneous microsaccades would enable the spider to see non-moving objects and structures without the need for locomotion. At the same time, the secondary eyes (which do adapt) would provide the spider with additional optical information regarding movement. This retinal adaptation of the secondary eyes could aid prey detection, for example, because a moving target would then 'pop out' even against a textured background. This two-channel visual input might be highly advantageous for the hunting spider.

The induced retinal movements that we describe can be characterized as saccades. Land (1969) described saccades of similar duration (100ms) and amplitude (15°) in the jumping spider *Metaphidippus aeneolus*. Salticid saccades are conjugate and their amplitude is large compared with the tiny field of view of their AM eyes (10° at most in a lateral plane). Therefore, they can be used to fixate a target onto the fovea of the retinae of both primary eyes. In *Cupiennius salei*, the limited range of movements of both retinae does not allow conjugate shifts of the visual fields of the AM eyes, which are much larger in this species (field of view lateral extent >60°). Compared with this, the amplitude of the induced movements is small, probably too small to be of any reasonable use in this context for the spider. One possible solution of this discrepancy would be a specialized subregion of the retina with a limited angular extent. However, recent histological studies (Grusch, 1994; A. Schmid, unpublished results) have shown that in *C. salei* the AM eyes have neither an anatomical fovea nor another specialized central subregion like those described in the principal retinae of lycosids and thomisids (Blest and O'Carroll, 1989). However, a neuronal or functional fovea cannot be excluded. Regarding the whole retina as a functional unit, it might also be possible to enlarge the amplitudes of the induced retinal movements with conjugated body movements. Therefore, saccadic retinal movements should be followed by a body saccade or whole-body turn towards the stimulus to capture and keep the target within the visual field of the AM eye. Preliminary behavioural studies have indeed shown such body saccades towards the site of mechanical stimulation. We have not yet investigated the correlation of these body and eye movements.

Animals with only their AM eyes uncovered are only slightly impaired in finding a target. In contrast, their ability to walk towards a visual target is highly impaired if the AM eyes are covered, even though the visual fields of the PM eyes and the AM eyes overlap almost completely (Land and Barth, 1992). The different anatomy and also the separate visual pathways of the principal eyes (AM) and of the three pairs of secondary eyes suggest that the biological functions of these eyes differ (Strausfeld and Barth, 1993; Strausfeld *et al.* 1993). The dependence of the spider's ability to find a target on the intactness of the AM eyes is thought to result from such differences. The motility of the AM eyes is likely to enable the

spider to detect stationary targets, especially in front of an unstructured or very low-contrast background.

We conclude that the motility of the AM eyes might be used to detect immobile targets of interest, such as stationary prey or the plants in which these spiders live, and also to shift the 'gaze' of the spider towards the direction of any mechanical stimulation.

We would like to thank Dr F. G. Barth, Dr M. F. Land, Dr M. Landolfi and two anonymous reviewers for critically reading and discussing the manuscript and all members of the Department of Neurobiology for their continuing and indispensable help. This work was supported by a grant from the Fonds zur Förderung der wissenschaftlichen Forschung, Austria P-9594-Bio to A.S.

### References

- BARTH, F. G., NAKAGAWA, T. AND EGUCHI, E. (1993). Vision in the ctenid spider *Cupiennius salei*: spectral range and absolute sensitivity. *J. exp. Biol.* **181**, 63–87.
- BERTKAU, P. (1886). Beiträge zur Kenntniss der Sinnesorgane der Spinnen. *Archs mikrosk. Anat.* **27**, 580–650.
- BLEST, A. D. AND O'CARROLL, D. (1989). Evolution of the tiered principal retinae of jumping spiders. In *Neurobiology of Sensory Systems* (ed. N. Sing and N. J. Strausfeld), pp. 155–170. New York: Plenum Publishing Corporation.
- BRANTS, A. (1838). Bijdragen tot de kennis van de eenvoudige oogen der gelede dieren. *Tijdschr. nat. Geschied.* **4**, 135–153.
- DEMOLL, R. (1917). *Die Sinnesorgane der Arthropoden. Ihr Bau und ihre Funktion*. Braunschweig: Vieweg & Sohn.
- FORSTER, L. (1985). Target discrimination in jumping spiders (Araneae: Salticidae). In *Neurobiology of Arachnids* (ed. F. G. Barth), pp. 249–274. Berlin: Springer-Verlag.
- GRENACHER, H. (1879). *Untersuchungen über das Sehorgan der Arthropoden*. Göttingen: Vandenhoeck & Ruprecht.
- GRUSCH, M. (1994). Feinstruktur und Retinalgehalt der Augen von *Cupiennius salei* (Araneidae, Ctenidae). Diplomarbeit, Universität Wien.
- LAND, M. F. (1969). Movements of the retinae of jumping spiders in the response to visual stimuli. *J. exp. Biol.* **51**, 471–493.
- LAND, M. F. (1985). The morphology and optics of spider eyes. In *Neurobiology of Arachnids* (ed. F. G. Barth), pp. 53–76. Berlin: Springer-Verlag.
- LAND, M. F. AND BARTH, F. G. (1992). The quality of vision in the ctenid spider *Cupiennius salei*. *J. exp. Biol.* **164**, 227–242.
- LEYDIG, F. (1855). Zum feineren Bau der Arthropoden. *Archs Anat. Physiol.* 376–480.
- MELAMED, J. AND TRUJILLO-CENOS, O. (1971). Innervation of the retinal muscles in wolfspiders. *J. Ultrastruct. Res.* **35**, 359–369.
- ROMEIS, B. (1989). *Mikroskopische Technik*. München: Urban & Schwarzenberg.
- STRAUSFELD, N. J. AND BARTH, F. G. (1993). Two visual systems in one brain: Neuropils serving the secondary eyes of the spider *Cupiennius salei*. *J. comp. Neurol.* **328**, 43–62.
- STRAUSFELD, N. J., WELTZIEN, P. AND BARTH, F. G. (1993). Two visual systems in one brain: Neuropils serving the principle eyes of the spider *Cupiennius salei*. *J. comp. Neurol.* **328**, 63–75.
- WIDMANN, E. (1908). Über den feineren Bau der Augen einiger Spinnen. *Z. wiss. Zool.* **90**, 259–308.