

ON THE MECHANISM OF WATER VAPOUR SORPTION FROM UNSATURATED ATMOSPHERES BY TICKS

K. GAEDE* AND W. KNÜLLE

Institut für Zoologie, Angewandte Zoologie/Ökologie der Tiere, Freie Universität Berlin, Haderslebener Straße 9, D-12163 Berlin, Germany

Accepted 14 March 1997

Summary

The nascent salivary secretion of 41 partly dehydrated and unfed adult female *Amblyomma variegatum*, 5–8 months post-ecdysis, during water vapour uptake at 93.5% relative humidity and 20 °C, had an osmolality of between 298.6 and 769.7 mosmol kg⁻¹ (mean ± s.d. 470.3 ± 85.8 mosmol kg⁻¹). This range would allow water vapour uptake at relative humidities of approximately 98–99%, but it would not suffice for lower relative humidities down to 80–85%, the critical equilibrium humidity of *A. variegatum*. At this relative humidity (85%), an osmolality of 9796 mosmol kg⁻¹ is required for water vapour uptake. It is proposed that hydrophilic cuticle in the hypostome could play a role in water condensation and that the slightly hyperosmotic secretion of the agranular alveoli of the salivary glands might alter the water affinity at the adsorbing cuticle surface and

release the adsorbed water. The water-enriched secretion would then be drawn into the mouth by the powerful suction of the pharynx. This hypothetical hydrophilic cuticle component of water vapour uptake in *A. variegatum* merits closer investigation. The sorption kinetics of *A. variegatum* support an additional ‘osmotic’ component of water vapour uptake at humidities near saturation.

A nanolitre osmometer particularly suited to sample volumes smaller than 5 nl was developed. This device does not require the transfer of fluid after collection, and its measurement range is extended beyond the 5 osmol kg⁻¹ that can be measured using commercial apparatus.

Key words: water balance, water vapour uptake, saliva, *Amblyomma variegatum*, tick.

Introduction

Water vapour uptake from an unsaturated atmosphere occurs in terrestrial insects, mites and isopods (Machin, 1979; Wharton, 1985; Knülle, 1986; O’Donnell and Machin, 1988; Hadley, 1994). The lower humidity limits for water vapour absorption range from 43% relative humidity (RH) to close to saturation, depending on the species and stage. The relative humidity at which the rate of water efflux (by transpiration) equals the rate of vapour influx (by sorption) is called the ‘critical equilibrium humidity’ (CEH). For species with very low transpiration rates, such as ticks, the water loss rates are a negligible fraction of the uptake rates and thus the CEH is identical to the ‘pump threshold’, the minimum humidity required for the water vapour sorption process. The mechanisms involved in the transfer of atmospheric water into the haemolymph of an arthropod against a steep thermodynamic gradient of water activity are of prime interest to physiologists.

The oral region has been identified as the water uptake site in the tick *Amblyomma variegatum* (Rudolph and Knülle, 1974). A hygroscopic salt solution, evidently secreted by the agranular alveoli of the salivary glands, has been implicated in

water vapour absorption. This was subsequently confirmed for other tick species (McMullen *et al.* 1976; Needham and Teel, 1986). Sigal *et al.* (1991) determined the osmolality of the oral secretion during active water vapour uptake of *A. americanum* and considered the value to be sufficient for water vapour absorption at humidities of 88% RH and above. The critical equilibrium humidity of *A. americanum* is between 80 and 85% RH (Jaworski *et al.* 1984; Needham *et al.* 1990). Hence, there is a discrepancy between the highest fluid osmolality measured in a single sample (6.5 osmol kg⁻¹, equivalent to a water activity of $a_w=0.896$) and that measured (9.8 osmol kg⁻¹, equivalent to an a_w of 0.85) at the critical equilibrium humidity of *A. americanum*. In addition, the thermal analysis of frozen sections employed by Sigal *et al.* (1991) may not provide a reliable indication of the melting point of oral fluid (O’Donnell, 1996). For these reasons, we have re-examined the conclusion of Sigal *et al.* (1991) that active water vapour uptake is a solute-driven process that is dependent upon the production of fluid with an osmolality high enough to absorb water at and above the critical equilibrium humidity.

However, there is a good evidence for the involvement in

*e-mail: konrad.gaede@parexel.de

active water vapour uptake of a fluid produced by the type I agranular alveoli of the salivary glands. First, adults of *Hyalomma anatolicum excavatum* absorbed water vapour in the absence of all granular alveoli (destroyed by infection with *Theileria annulata*) but with their agranular alveoli intact, suggesting the involvement of the latter in water vapour uptake (Rudolph and Knülle, 1978). Second, in immature *Ixodes ricinus*, the initiation of water vapour uptake after feeding coincides with the restoration to the prefeeding condition of the agranular alveoli, although the granular alveoli remain degenerated (Kahl *et al.* 1990). Third, the lamellate cells of the agranular alveoli, which have features characteristic of transport epithelia, are most likely to secrete the fluid involved in water vapour uptake. A correlation has been reported between ultrastructural changes in these cells and physiological changes; for example, mitochondria in the lamellate cells alter their configuration as the hydration state of the animal changes (Needham *et al.* 1990).

In the present investigation on *A. variegatum*, the osmolality measured in the oral fluid of rehydrating females would allow water vapour uptake at relative humidities of approximately 98–99%, but would not suffice for water vapour uptake at lower humidities down to the critical equilibrium humidity of this species (80–85% RH). It is proposed that hydrophilic cuticle lining the hypostome, in particular the hypostomal membrane, could play a role in water vapour uptake (for morphological details of the gnathosoma, see Fig. 1). Water vapour uptake in *A. variegatum* might then be caused by a very small 'osmotic' component due to the salivary secretion (effective only at humidities near saturation) and a substantially greater component associated with the hydrophilic cuticle of the hypostome. The ion-containing salivary secretion, when ejected, may reduce the water affinity of certain cuticle regions, such as the dorsal membrane of the hypostome, and thus release the condensed water. The water-enriched fluid would then be swallowed, and water and ions transferred to the gut. This is a tentative hypothesis based on the results of the experiments described below.

Materials and methods

A large tick species (the tropical bont tick *Amblyomma variegatum* Fabricius) was chosen since the volume of saliva was likely to be small in smaller species.

Experimental sequence

The mass of the tick was determined to 0.1 mg using a CAHN G-2 microbalance, before and after exposure to dry conditions ($a_v=0.0$, above P_2O_5) and room temperature (approximately 20°C). The initial mass (mass at equilibrium with $a_v=0.90$) of 41 unfed adult female *A. variegatum*, 5–8 months post-ecdysis, was 35.23 ± 5.18 mg (mean \pm S.D.). After 5–16 days of desiccation, the water deficits of these partially dehydrated ticks ranged from –2.77 to –16.52% of their initial masses (mean \pm S.D. -7.38 ± 3.77 %) or, in terms of body water content, the water deficits ranged from –6.10 to

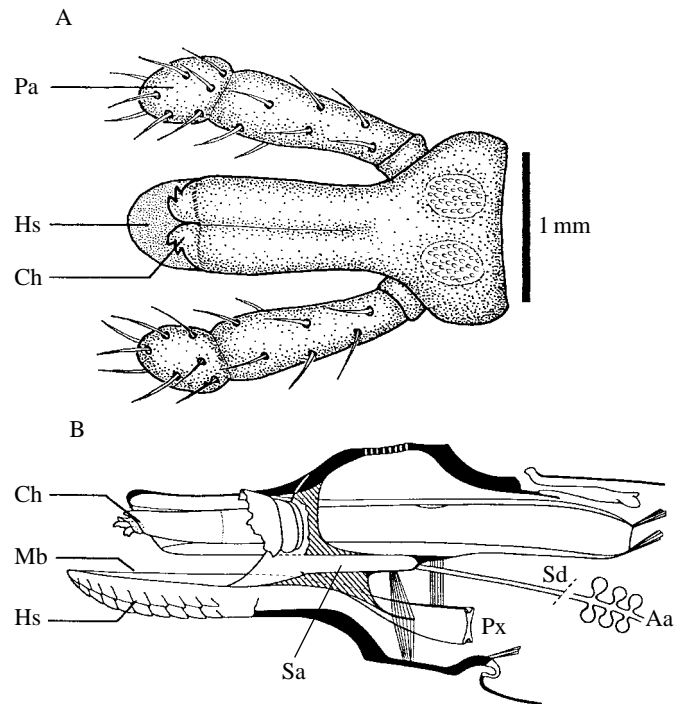

Fig. 1. Schematic illustration of the tick gnathosoma. (A) Dorsal view, (B) sagittal section. Aa, agranular alveoli; Ch, chelicerae; Hs, hypostome; Mb, hypostomal membrane; Pa, pedipalpus; Px, pharynx; Sa, salivarium; Sd, salivary duct.

–26.76% of their initial water contents (mean \pm S.D. -12.01 ± 5.25 %).

Following exposure to dry air, saliva and haemolymph samples were taken from ticks during rehydration at 93.5% RH and 20°C. Parallel experiments demonstrated a mass increase under the same humidity conditions. Saliva and haemolymph samples (see below for collection procedures) were obtained from the same animals without using artificial stimulation. After determination of the sample osmolality from freezing-point depression using a purpose-designed osmometer (see below), the volume of the saliva sample was measured using a microscope. The average sample volume was 2.20 ± 1.41 nl (mean \pm S.D.). The smallest sample volume for which freezing-point depression could be measured was 0.27 nl. Experiments in which smaller saliva sample volumes were obtained were discarded.

After saliva and haemolymph samples had been obtained, the ticks were reweighed. The tarsus, removed during haemolymph collection, was neglected. Finally, the dry mass was determined after the tick had been dried in a vacuum at 40°C for at least 3 days.

Sample extraction and preparation

The partially dehydrated ticks (as described above) were exposed for at least 1 h to an atmosphere with a water vapour activity a_v of 0.935 at a temperature of approximately 20°C. The ticks were suspended in these conditions above a small glass trough containing saturated KNO_3 solution, see Fig. 2.

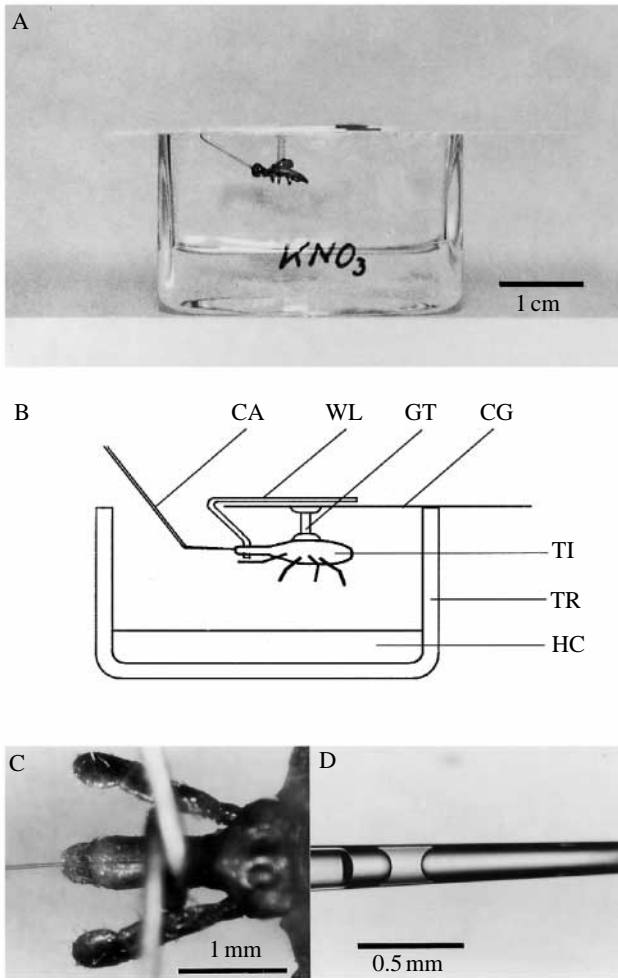

Fig. 2. Preparation of *Amblyomma variegatum* used to obtain saliva samples. (A,B) The glass trough with the prepared tick suspended above a saturated KNO_3 solution. (C) Gnathosoma of the tick seen from above with the capillary in position. (D) Capillary containing a saliva sample prepared for measurement of osmolality. CA, capillary; WL, wire loop; GT, glass tack with tick attached using sealing-wax; CG, coverglass; TI, tick; TR, trough; HC, humidity-controlling solution (saturated KNO_3 solution).

The trough was covered completely using a glass lid (24 mm×50 mm). A glass tack was glued to the lower side of the coverglass, to which the tick was attached using sealing-wax, so that it was positioned in the middle of the trough. This treatment did not impair the sorption capability of the ticks. Control ticks, attached using sealing-wax to a small wire hook and placed on a continuously recording balance (Sartorius 4431), started vapour sorption within a few minutes. Sorption continued over many hours or days depending on the degree of previous dehydration of the ticks. A piece of cobalt thiocyanate paper was glued to the coverglass to obtain a continuous indication of the relative humidity level within the trough (Solomon, 1945).

A saliva sample was taken using a finely drawn capillary tube, produced using a micropipette puller (Leitz) and a microburner. When parts of the gnathosoma – in particular,

certain setae of the mouthparts – are touched, the tick moves the gnathosoma repeatedly in a dorsal and ventral direction. It was therefore necessary to fix the gnathosoma using a wire loop attached to the upper side of the coverglass via a piece of ribbon (Fig. 2C). The thin wire (0.2 mm in diameter) runs around hypostome and chelicerae, spreading the palps laterally. In ticks prepared in this way, the opening of the small channel between the hypostome and chelicerae was readily visible from above. Spreading the palps had no deleterious effect on the sorption capability of the ticks.

The tip of the capillary was bent such that the capillary fitted into the trough (Fig. 2B). For sample extraction, a stereomicroscope was used and the capillary was introduced between the hypostome and chelicerae up to the basis capituli. A micromanipulator was not used for sample extraction, because this increased the time required for subsequent treatment of the sample. Contact of the sample with room air should be as short as possible to avoid concentration changes in the saliva sample. Contact of the sample with air was prevented by enclosing the sample on both sides with paraffin oil. The capillary was dipped briefly in paraffin oil before sample extraction, the saliva then entered the fine end of the capillary tube by capillarity, and finally the capillary was attached to a micropipette tube and paraffin oil was sucked into it until the sample moved to the enlarged part of the capillary. The fine end was snapped off and the opening closed by dipping briefly in melted paraffin. A sample prepared in this way is shown in Fig. 2D.

It was not possible to obtain a saliva sample in all cases. If, in repeated trials, a saliva sample could not be obtained, the tick was discarded. In a few cases, the tick was accidentally injured and haemolymph entered the capillary. This could readily be recognised, because the haemolymph has a turquoise colour, unlike the saliva. Extremely small samples were also discarded, on the basis of the criteria discussed above.

Following saliva collection, the tick was detached from the apparatus and a haemolymph sample was collected. A tarsus was removed and haemolymph was collected from the opening using a microcapillary. The haemolymph sample was prepared as described above for saliva samples (sample volume approximately 5 nl).

Nanolitre osmometer

A novel type of nanolitre osmometer was specially constructed for this study. Commercial nanolitre osmometers have a range of 0–5 osmol, with a minimum sample volume of approximately 5 nl (e.g. Clifton nanolitre osmometer). For highly concentrated saliva samples, such as at first expected in this study, this range was not sufficient. Furthermore, our sample volumes were also usually smaller than 5 nl. To overcome this limitation, measurements were made directly using the sampling capillary and without transferring the sample to other media.

The osmometer works as follows: the frozen sample is submerged in a cooled bath of 90% ethanol. The temperature of the bath is measured next to the sample using a thermocouple (resolution 0.01 °C). After temperature

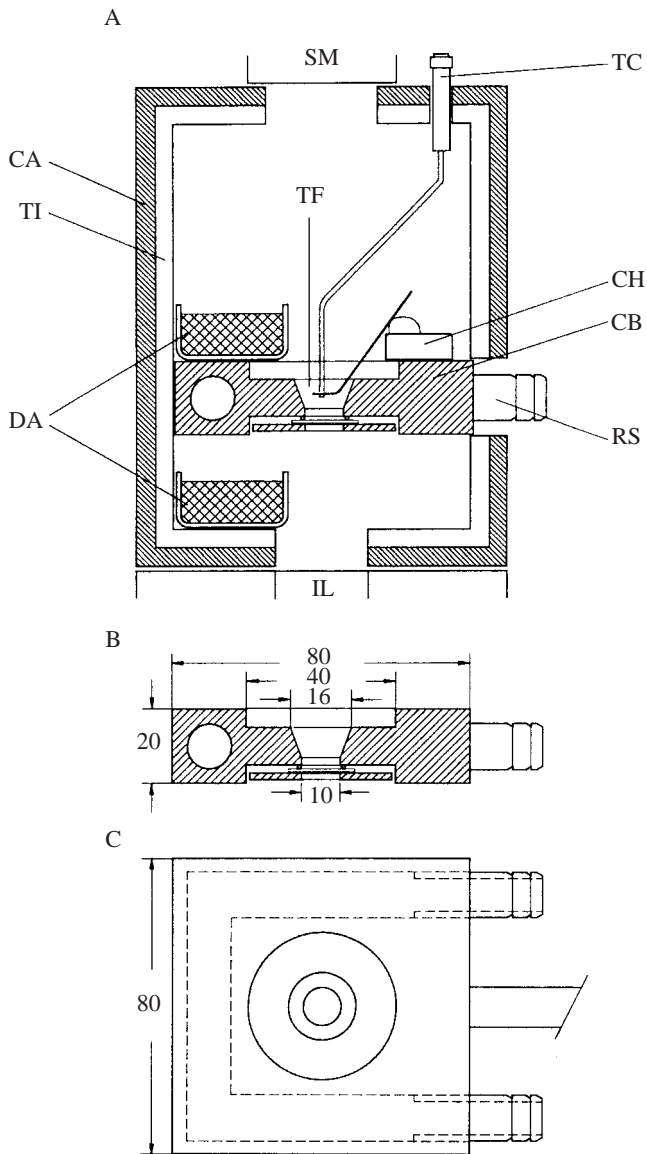

Fig. 3. Nanolitre osmometer. (A) Vertical section plan of the osmometer. (B) Cooling block, vertical section (plastic fixing rod not shown). (C) Cooling block from above. RS, refrigerant supply; IL, illumination; CA, cabinet; CB, cooling block; CH, capillary holder with a capillary cemented in place; SM, stereomicroscope; TC, thermocouple; TF, temperature-regulated fluid (90% ethanol); TI, thermoisolating layer; DA, drying agent (phosphorus pentoxide). In B and C, dimensions are given in mm.

equalisation (a few minutes), the cooling system is turned off and the liquid bath slowly warms up (at $0.2^{\circ}\text{C min}^{-1}$). At the same time, the sample is illuminated from below through a glass window in the bottom of the ethanol bath and is observed with a stereomicroscope. The temperature of the liquid bath is recorded continuously and is noted at the time when the last ice crystal disappears.

The osmometer was constructed as shown in Fig. 3. The ethanol bath is located in a conical opening in the centre of a cooling block made of brass. The bottom of the bath is

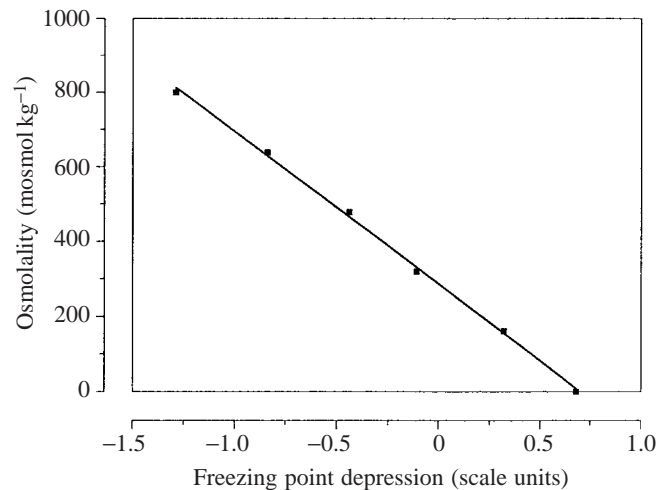

Fig. 4. Example of a calibration curve for the nanoliter osmometer shown in Fig. 3. Distilled water or solutions of NaCl of varying osmolality were used, and their freezing points determined.

constructed from a small pane of glass, fixed in place by a holder ring. The cooling fluid (90% ethanol) runs through the cooling block in an U-shaped canal. The whole device is situated in a jacket in which a low air humidity (produced by a drying agent) is maintained to avoid the formation of ice crystals on the observation window. The complete system is also temperature-insulated, giving a slow rate of temperature increase when the sample is thawing.

The measurements were performed in the following way. A capillary was glued to the capillary holder such that the sample could be located in the middle of the ethanol bath next to the tip of the thermocouple. A small amount (approximately 10 ml) of Freon 11 (trichlorofluoromethane, freezing point -111°C) was cooled with liquid nitrogen until half of it was frozen. The tip of the sample capillary was dipped into the liquid Freon for 10 s and then transferred quickly into the cooled ethanol bath. After approximately 10 min, when most of the small ice crystals had fused to form larger ones, the cooling device was switched off. The moment at which the last ice crystal melted was marked on the temperature recording.

For calibration of the osmometer, distilled water and NaCl solutions with concentrations of 0.5–2.5% in steps of 0.5% were used (Fig. 4). Calibration curves were constructed by plotting thermocouple output against the known osmolality of the calibration solutions (strictly speaking, the abscissa of the calibration curve shows the thermocouple output transformed to a biased temperature scale). Because the thermocouple response drifted over several days, a new calibration curve was prepared each day, and sample measurements were interspersed with measurements of the calibration solutions.

Statistical calculations

Descriptive statistics and regression analysis were performed using SPSS/PC+ V2.0 and PlotIT V1.5. The haemolymph and saliva osmolality were compared using the paired sample *t*-test.

Fig. 5. Haemolymph osmolality increases with dehydration in *Amblyomma variegatum* (A). Saliva osmolality versus haemolymph osmolality (B).

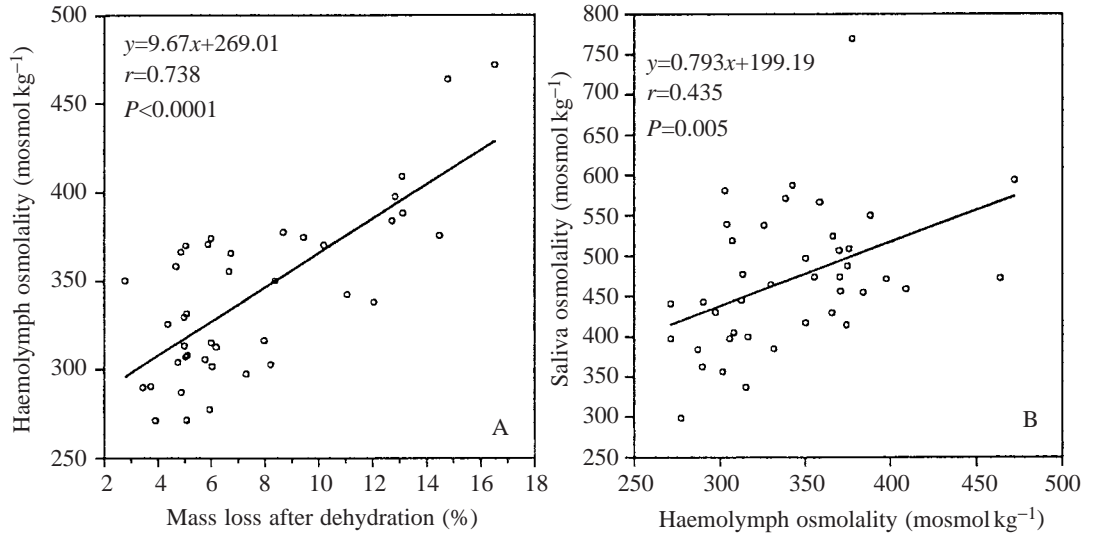

Results

The mean osmolality (\pm s.d.) of the haemolymph of *A. variegatum* was 341.7 ± 46.96 mosmol kg^{-1} ($N=41$), with a range of $271.3\text{--}472.0$ mosmol kg^{-1} . Values increased significantly with increasing degree of dehydration, $r=0.738$, $P<0.0001$ (Fig. 5A). Comparable values showing an increase in haemolymph concentration (given as freezing point depression) following dehydration are given by Chi-Yen *et al.* (1973) for *A. americanum*. For ‘moderately hydrated’ ticks (mass changes -5% to $+5\%$) and ‘severely dehydrated’ ticks (mass changes $\geq 10\%$), they found values corresponding to 413.3 mosmol kg^{-1} and 548.4 mosmol kg^{-1} , respectively. These values are somewhat higher than ours and, apart from possible species differences, the ticks were younger in the study presented here and the pre-treatment was different.

The mean osmolality (\pm s.d.) of the saliva of *A. variegatum* was 470.3 ± 85.75 mosmol kg^{-1} with a range of $298.6\text{--}769.7$ mosmol kg^{-1} . The difference between the haemolymph and saliva osmotic values is highly significant ($P \leq 0.001$) (Fig. 6). The saliva osmolality increases with increasing haemolymph osmolality (Fig. 5B) ($P=0.005$, $r=0.435$). The saliva is always slightly more concentrated

than the haemolymph. The ratio of saliva osmolality to haemolymph osmolality is 1.39 ± 0.24 and is independent of the degree of dehydration ($r=-0.087$).

For the tick salivary secretion to be responsible for water vapour sorption at 93.5% RH ($a_v=0.935$), osmolality must be greater than 3859 mosmol kg^{-1} (Table 1), as this represents an equilibrium value. Measured osmolalities of the salivary secretion at this relative humidity, however, were approximately one order of magnitude smaller ($298.6\text{--}769.7$ mosmol kg^{-1}). Therefore, the osmolality of the salivary secretion of the tick cannot explain its water vapour sorption capability at 93.5% RH and also at lower humidities down to the critical equilibrium humidity for the tick of $80\text{--}85\%$ RH. Even if the saliva composition varies during rehydration, some of the 41 samples obtained should have shown higher osmolalities for it to act in this way.

One possible role for saliva in the absorption process is suggested by a comparison between the water activity of the saliva and the sorption kinetics of *A. variegatum* (Gaede, 1991). Fig. 7A shows that, at humidities close to saturation, the sorption rate is higher than would be expected from extrapolation of rates measured at water vapour activities

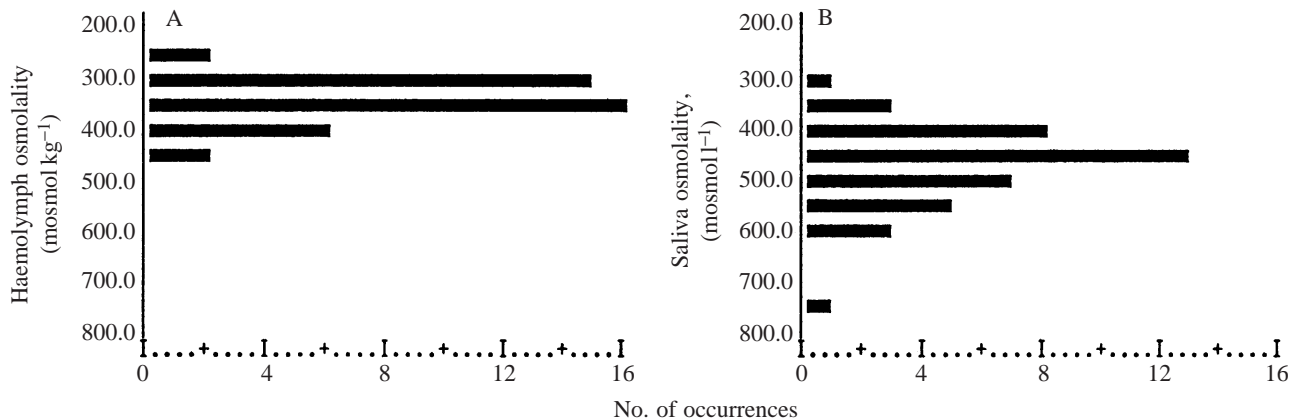

Fig. 6. Histograms showing (A) haemolymph and (B) saliva osmolality of 41 *Amblyomma variegatum* females.

Table 1. *Some colligative properties of aqueous solutions*

Water activity, a_w	Osmolality (osmol kg ⁻¹)	Freezing-point depression (°C)
0.80	13.877	25.783
0.85	9.796	18.201
0.90	6.168	11.516
0.935	3.859	7.170
0.95	2.921	5.427
0.98	1.133	2.105
0.99	0.561	1.042
1.00	0.000	0.000

Data are taken from Arlian and Veselica (1979).

below 0.98. The frequency distribution of the saliva osmolalities (converted to values of water activity to allow a direct comparison) are shown in Fig. 7B. The increased rate above that predicted by extrapolation of the solid line in Fig. 7A is consistent with a condensation of water vapour onto the slightly hypertonic saliva. The bulk of water vapour sorption, however, must be due to other causes. More precisely, solute-independent hygroscopic effects may be involved over the range of water vapour activities between the critical equilibrium humidity and humidities close to saturation. The possible involvement of hydrophilic structures onto which atmospheric water could condense was therefore examined further.

Of particular interest in this regard is the hypostome. Its dorsal surface is covered by a cushion-like vaulted membrane. The following experiment showed that it had hydrophilic properties. A hypostome and (for comparison) a palpus were cut off and sealed using a wax droplet. These preparations were dehydrated (over P₂O₅) to constant mass on a recording balance and were then exposed to a high water vapour activity (93.5% RH). Fig. 8 shows that the hypostome lost water very rapidly in dry air and regained this water immediately upon exposure to 93.5% RH. The palpus, in contrast, lost water very

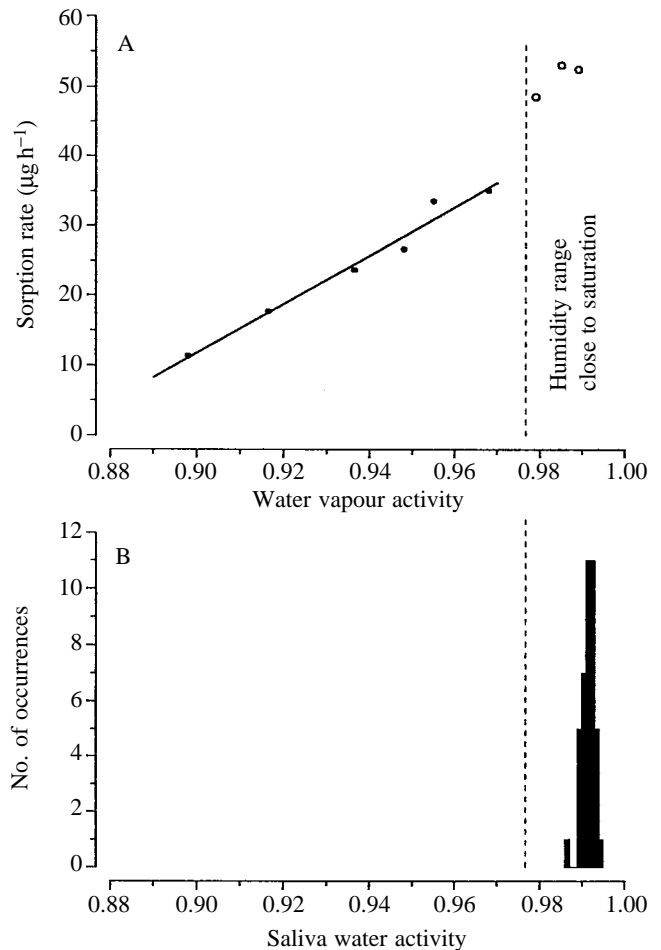

Fig. 7. Comparison of sorption kinetics and saliva osmolality of *Amblyomma variegatum*. (A) Sorption kinetics: sorption rate versus water vapour activity (the water vapour activity is a measure of the air humidity). (B) Frequency distribution of the saliva osmolalities in 41 rehydrating females, converted to values of water activity to allow a direct comparison (the water activity is a measure of the water concentration of a solution that is in equilibrium with the water vapour activity above the solution).

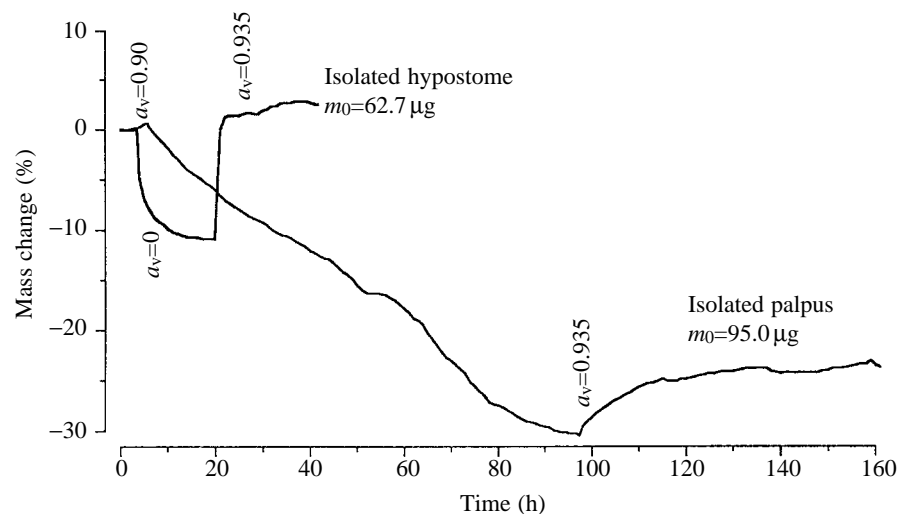
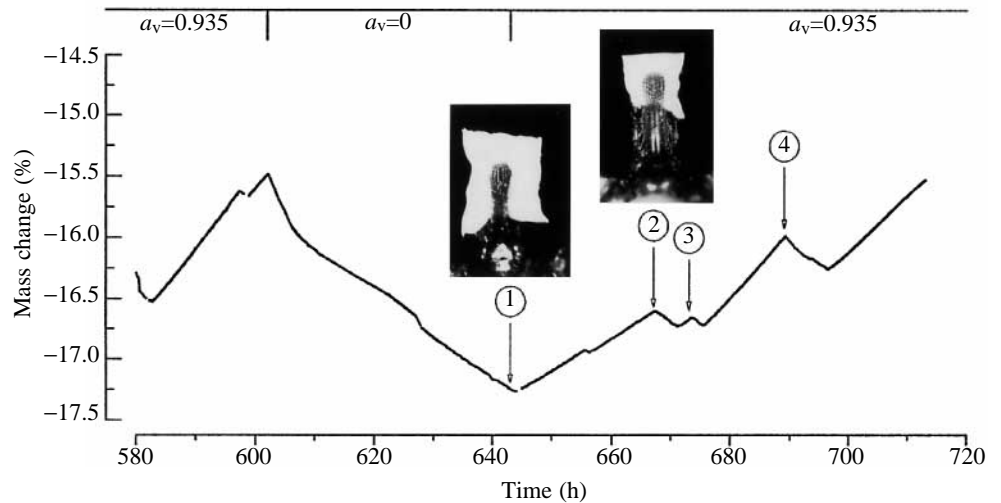

Fig. 8. Mass changes of the hypostome and palpus of a *Amblyomma variegatum* in dry ($a_v=0$) and humid ($a_v=0.935$) air. m_0 , initial mass.

Fig. 9. Experiment demonstrating the participation of the hypostome of *Amblyomma variegatum* in the sorption process. Point 1, the dorsal surface of the hypostome is covered with a layer of Teflon film to the basis capituli. Point 2, the Teflon film covers the distal half of the hypostome. Point 3, the Teflon film is removed. Point 4, the palpi are spread laterally using a wire loop. Photographs 1 and 2 were taken from the ventral side.



slowly (over a time span of approximately 4 days) and regained only a small part of it, at a slow rate, at 93.5 % RH.

If the hypostome or hypostomal membrane is the site of water vapour condensation, sorption is not restricted to its distal part (or this structure is not the only site of condensation). This was shown by an experiment in which the dorsal side of the hypostome was covered with a thin film of Teflon in such a way that the barrier was placed between the hypostome and chelicerae (Fig. 9). The sorption capability of a partially dehydrated female *A. variegatum* was first measured as $26.3 \mu\text{g h}^{-1}$ at $a_v=0.935$. After a further exposure to dry air, the Teflon film was introduced as far as possible between the hypostome and the chelicerae (point 1 in Fig. 9; the photograph shows the preparation from the ventral side, the covered part of the hypostome corresponds approximately to the detached part of the hypostome used in the experiment described above). Sorption rate decreased to $14.25 \mu\text{g h}^{-1}$ during the ensuing humidity exposure (93.5 % RH). When the Teflon film was pulled out half-way (point 2, Fig. 9), the rate of sorption increased to $16.13 \mu\text{g h}^{-1}$. Following complete removal of the film (point 3, Fig. 9), the original sorption rate was almost completely restored ($22.5 \mu\text{g h}^{-1}$). Spreading the palps by means of a wire loop (point 4, Fig. 9) decreased the rate of sorption slightly ($17.5 \mu\text{g h}^{-1}$).

Discussion

It is likely, from the evidence described above and the known participation of the agranular alveoli of the salivary glands in the sorption process, that the secretion of the agranular alveoli performs a double function. First, in unfed ticks with a large water deficit, surplus ions and other substances are temporarily removed from the haemolymph by the production of hypertonic saliva (termed 'osmoregulatory salivation' by Knülle and Rudolph, 1982, and 'storage excretion' by Needham and Teel, 1986, 1991). Ejected onto the gnathosoma, the saliva dries at low ambient humidities and a mainly crystalline substance remains (Rudolph and Knülle,

1974, 1978). When the humidity increases and ambient water vapour activities above the critical equilibrium value are reached, this substance dissolves and is swallowed (Needham and Teel, 1986). Second, if water vapour is absorbed at subsaturated humidities by the hydrophilic cuticle, the salivary secretion could play a role in temporarily reducing the water affinity of the hydrophilic cuticle and hence in transferring the condensed water to the gut *via* the powerful sucking action of the pharynx. Pumping movements in the region of the pharynx can be seen in ticks and a clear fluid can be observed in the buccal channel during absorption, which indeed suggests that hydrated saliva is swallowed (Knülle and Rudolph, 1982).

Further experimental work is required to elucidate the mechanism that enables ticks to extract water from unsaturated atmospheres. We are aware that mechanical stimulation of the sensitive oral region by the capillary tube used in the present study may have influenced the osmolality and composition of the salivary secretion, and that it is also possible that the hydrophilic properties that we describe for the cuticle in the oral region might be more relevant to achieving a smooth blood flow while feeding from the host. However, condensation of water on such hydrophilic cuticular structures is a realistic mechanism by which to obtain atmospheric water. The desert cockroach *Arenivaga investigata* also uses this principle (O'Donnell, 1982a,b; O'Donnell and Machin, 1988).

References

- ARLIAN, L. G. AND VESELICA, M. M. (1979). Water balance in insects and mites. *Comp. Biochem. Physiol.* **64A**, 191–200.
- CHI-YEN, S., SAUER, J. R., EICKENBARY, P., HAIR, J. A. AND FRICK, J. H. (1973). The effects of desiccation and rehydration on the lone star tick. *J. Insect Physiol.* **19**, 505–514.
- GAEDE, K. (1991). Aktive Aufnahme von Wasserdampf aus ungesättigter Atmosphäre bei Arthropoden: Sorptionskinetiken. *Zool. Jb. Physiol.* **95**, 135–171.
- HADLEY, N. F. (1994). *Water Relations of Terrestrial Arthropods*. New York, London: Academic Press.
- JAWORSKI, D. C., SAUER, J. R., WILLIAMS, J. P., NCNEW, R. W. AND

- HAIR, J. A. (1984). Age-related effects on water, lipid, hemoglobin and critical equilibrium humidity in unfed adult lone star ticks (Acari: Ixodidae). *J. med. Ent.* **21**, 100–104.
- KAHL, O., HOFF, R. AND KNÜLLE, W. (1990). Gross morphological changes of the salivary glands of *Ixodes ricinus* (Acari: Ixodidae) between blood meals in relation to active uptake of atmospheric water. *Exp. appl. Acarol.* **9**, 239–258.
- KNÜLLE, W. (1986). Aktive Aufnahme von Wasserdampf aus der ungesättigten Atmosphäre bei Arthropoden. *Zool. Beitr.* **30**, 393–408.
- KNÜLLE, W. AND RUDOLPH, D. (1982). Humidity relationships and water balance of ticks. In *Physiology of Ticks* (ed. F. D. Obenchain and R. L. Galun), pp. 43–70. Oxford: Pergamon Press.
- MACHIN, J. (1979). Atmospheric water absorption in arthropods. *Adv. Insect Physiol.* **14**, 1–48.
- MCMULLEN, H. L., SAUER, J. R. AND BURTON, R. L. (1976). Possible role in uptake of water vapour by ixodid tick salivary glands. *J. Insect Physiol.* **22**, 1281–1285.
- NEEDHAM, G. R., ROSELL, R., GREENWALD, L. AND COONS, L. B. (1990). Ultrastructure of type I salivary gland acini in four species of ticks and the influence of hydration states on the type I acini of *Amblyomma americanum*. *Exp. appl. Acarol.* **10**, 83–104.
- NEEDHAM, G. R. AND TEEL, P. D. (1986). Water balance by ticks between blood meals. In *Morphology, Physiology and Behavioral Biology of Ticks* (ed. J. R. Sauer and J. A. Hair), pp. 100–151. Chichester: Ellis Horwood.
- NEEDHAM, G. R. AND TEEL, P. D. (1991). Off-host physiological ecology of ixodid ticks. *A. Rev. Ent.* **36**, 659–681.
- O'DONNELL, M. J. (1982a). Water vapour absorption by the desert burrowing cockroach *Arenivaga investigata*: evidence against a solute-dependent mechanism. *J. exp. Biol.* **96**, 251–262.
- O'DONNELL, M. J. (1982b). Hydrophilic cuticle – the basis for water vapour absorption by the desert burrowing cockroach *Arenivaga investigata*. *J. exp. Biol.* **99**, 43–60.
- O'DONNELL, M. J. (1997). Mechanisms of excretion and ion transport in invertebrates. In *Handbook of Comparative Physiology* (ed. W. H. Dartzler), in press. New York: Oxford University Press.
- O'DONNELL, M. J. AND MACHIN, J. (1988). Water vapour absorption by terrestrial organisms. In *Advances in Comparative and Environmental Physiology*, vol. 2 (ed. R. Gilles), pp. 47–90. Berlin, Heidelberg: Springer.
- RUDOLPH, D. AND KNÜLLE, W. (1974). Site and mechanism of water vapour uptake from the atmosphere in ixodid ticks. *Nature* **249**, 84–85.
- RUDOLPH, D. AND KNÜLLE, W. (1978). Uptake of water vapour from the air: process, site and mechanism in ticks. In *Comparative Physiology: Water, Ions and Fluid Mechanics* (ed. K. Schmidt-Nielsen, L. Bolis and S. H. P. Maddrell), pp. 97–113. Cambridge: Cambridge University Press.
- RUDOLPH, D. AND KNÜLLE, W. (1982). Novel uptake systems for atmospheric water vapor among insects. *J. exp. Zool.* **222**, 321–333.
- SIGAL, M. D., MACHIN, J. AND NEEDHAM, G. R. (1991). Hyperosmotic oral fluid secretion during active water vapour absorption and during desiccation – induced storage-excretion by the unfed female tick *Amblyomma americanum*. *J. exp. Biol.* **157**, 585–591.
- SOLOMON, M. E. (1945). The use of cobalt salts as indicators of humidity and moisture. *Annls appl. Biol.* **32**, 75–85.
- WHARTON, G. W. (1985). Water balance of insects. In *Comprehensive Insect Physiology, Biochemistry and Pharmacology*, vol. 4 (ed. G. A. Kerkut and L. I. Gilbert), pp. 565–601. Oxford, New York: Pergamon Press.