

## Nitric oxide mediates seasonal muscle potentiation in clam gills

Louis F. Gainey, Jr<sup>1,\*</sup> and Michael J. Greenberg<sup>2</sup>

<sup>1</sup>Department of Biological Sciences, University of Southern Maine, Portland, Maine, 04104, USA and <sup>2</sup>The Whitney Laboratory, The University of Florida, 9505 Ocean Shore Boulevard, St Augustine, Florida, 32086, USA

\*Author for correspondence (e-mail: gainey@usm.maine.edu)

Accepted 27 June 2003

### Summary

The physiology and timing of gill muscle potentiation were explored in the clam *Mercenaria mercenaria*. When isolated demibranchs were exposed twice (with an intervening wash) to the same concentration of 5-hydroxytryptamine, the second contraction was larger than the first. This potentiation was seasonal: it was present from November through June, and absent from July through October. Potentiation was not affected by the geographic origin of the clams, nor by their acclimation temperature. Potentiation was inhibited by the nitric oxide synthase (NOS) inhibitor L-NAME and mimicked by the nitric oxide (NO) donor DEANO. During the season of potentiation, immunoreactive NOS appeared in the gill muscles and the gill filament epithelium, but during the off-season, the enzyme occurred at the base of the gill

filaments. Potentiation was inhibited by ODQ, which inhibits soluble guanylate cyclase (sGC), and it was mimicked by dibutyl-*c*-GMP, an analog of cyclic GMP (cGMP). Moreover, potentiation was inhibited by the protein kinase G (PKG) inhibitor Rp-8-CPT-*c*-GMPS. During the season of potentiation, immunoreactive sGC was concentrated in the gill muscles and the gill filament epithelium; but during the off-season, immunoreactive sGC was found in the gill filament epithelium. These data suggest that the potentiation of gill muscle is mediated by a NO/cGMP/PKG signaling pathway.

Key words: clam, *Mercenaria mercenaria*, gill, muscle, nitric oxide (NO), potentiation, season, signaling pathway.

### Introduction

Because most bivalve molluscs are filter feeders, the gills serve dual functions, feeding and respiration, and are thus very complex organs. For several years, we have been investigating the neural control of the cilia and musculature in the gills of the quahog *Mercenaria mercenaria* (Gainey et al., 1999a, 2003). In this report, we consider a long-term potentiation of the gill musculature that is induced seasonally by 5-hydroxytryptamine (5HT) and is mediated by a nitric oxide/cyclic GMP/protein kinase G (NO/cGMP/PK-G) pathway.

In addition to being eulamellibranch, the gills of *Mercenaria* are also plicate (Kellogg, 1892). That is, adjacent filaments are connected to each other by interfilament tissue junctions, while the ascending and descending filaments within each demibranch are connected at intervals by interlamellar tissue junctions (i.e. the septa), an arrangement that produces the plicae and the water tubes (Fig. 1). Water flow through the gill is determined by both the rate of beat of the lateral cilia and the geometry of the gill, which includes the spacing of the filaments, the shape of the plicae, and the diameter of the water tubes. These geometric parameters are controlled by the contractile state of the gill musculature, which consists of two distinct domains: the longitudinal/dorso-ventral muscles, and the water tube muscles. In particular, contraction of the

longitudinal muscles reduces the length of the gill and narrows the spacing between adjacent filaments, whereas contraction of the water tube muscles constricts the diameter of the water tubes and changes the shape of the plicae (Gainey et al., 2003).

We recently demonstrated a complex network of dopaminergic and serotonergic fibers associated with the musculature in the gill and proposed, on pharmacological evidence, that 5HT is the excitatory and ACh the inhibitory transmitter to those muscles (Gainey et al., 2003). During that investigation, we discovered, quite by accident, that if a gill was exposed twice to the same concentration of 5HT (with a wash between doses), then the second contraction was typically larger than the first. We hypothesized that this potentiation might be mediated by NO because, although this molecule is best known as a gaseous, inter-neuronal signaling agent, it is also synthesized in muscle, where it modulates contractility.

In vertebrates, NO modulates the activity of the three classes of muscle: cardiac, skeletal and smooth, but its effects in these muscles are complex and variable (for reviews on cardiac muscle, see Brady et al., 1993; Hare and Stammler, 1999; Ohba and Kawata, 1999; Petroff et al., 2001; Satoh and Naoki, 2001; Reading and Barclay, 2002; for skeletal muscle, see Marechal and Gailly, 1999; Stamler and Meissner, 2001; for smooth

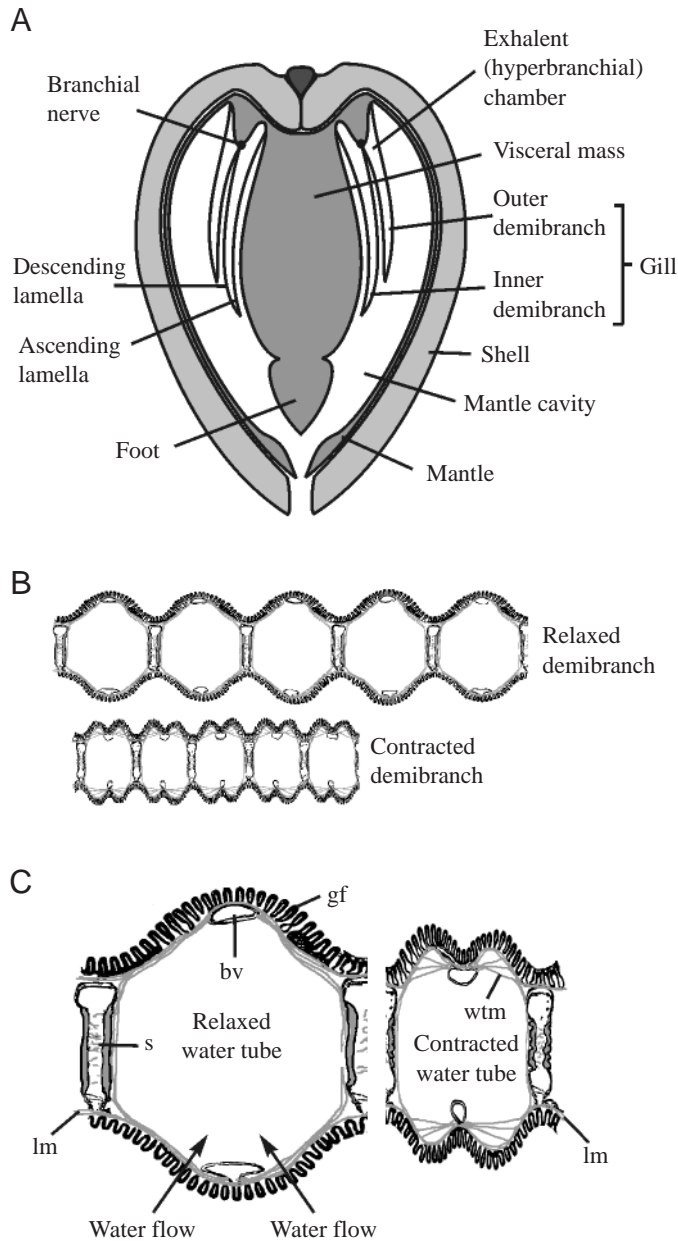

Fig. 1. Diagrammatic anatomy of *Mercenaria mercenaria* (adapted from Gainey et al., 2003). (A) Cross section of a clam. (B) Cross sections through portions of relaxed and contracted demibranchs cut in an anterior–posterior direction, i.e. in and out of the plane of the page with respect to the top figure. (C) Details of a water tube: with the musculature relaxed (left), and contracted (right). The water tube muscles are within the walls of the horizontal blood vessels, the vessels are not shown here. The longitudinal muscles lie between the water tube muscles (and the horizontal blood vessels) and the base of the gill filaments. bv, blood vessel; gf, gill filament; lm, longitudinal muscle; s, septum; wtm, water tube muscle.

muscle, see Buchwalow et al., 2002). Nitric oxide synthase (NOS) has also been demonstrated in all classes of molluscs except Monoplacophora and Aplousophora (reviewed by Moroz and Gillette, 1995; Untch et al., 1999), and NO relaxes vascular

muscle in the cuttlefish *Sepia officinalis* (Schippe and Gebaure, 1999). More to the point, in *Mercenaria*, NOS has been localized using the NADPH-diaphorase technique to such non-neuronal tissue as the gill muscles and the cilia of the gut (Untch et al., 1999). Moreover, a small fragment of a gene encoding NOS (~129 bp) has been cloned from *Mercenaria*; the amino acid sequence is 71% similar to the calmodulin binding site of human neuronal NOS (L. L. Moroz and B. Untch, University of Florida, personal communication).

The mechanisms whereby NO exerts its effects within cells fall into two broad categories: S-nitrosylation of effector proteins, and stimulation of soluble guanylate cyclase (sGC) leading to an increase in the concentration of cGMP (see reviews by Denninger and Marletta, 1999; Jaffrey et al., 2001). Within invertebrate neurons and muscles, however, signaling appears to be confined to the cGMP pathway (*Aplysia californica* neurons, Koh and Jacklet, 1999; *Asterias rubens* muscle, Elphick and Melarange, 2001; *Idotea baltica* muscle, Erxleben and Hermann, 2001; *Sepia officinalis* muscle, Schippe and Gebauer, 1999).

To test our hypothesis about the 5HT-induced potentiation of gill musculature, we: (1) studied the time course and seasonal occurrence of this potentiation; (2) investigated the pharmacology of agents that act at various stages in the NO/cGMP/PK-G signaling pathway; (3) determined the immunohistochemical distribution of NOS and sGC. Preliminary results of this study were presented to the Society for Integrative and Comparative Biology and the Society for Neuroscience (Gainey et al., 1999b; Greenberg et al., 2000).

## Materials and methods

### Animals

Quahogs *Mercenaria mercenaria* L. that had been dug from various locales along the northeast Atlantic coast (but mostly from Cape Cod), were purchased from Harbor Fish Market and Hannaford Brothers in Portland, Maine, USA. In the text, we refer to these animals as northern clams. Quahogs were also dug from Salt Run, a narrow tidal embayment, in St. Augustine, Florida. In the text, we refer to these animals as Florida clams. Unless otherwise noted in the text, the animals were held at 10°C on a 12 h:12 h light:dark cycle. All animals were held in 30‰ natural seawater. Individuals were held a minimum of 3 days before use.

### Gill preparation and apparatus

Gills were dissected away from the body wall, separated into demibranchs, and the main trunks of the branchial nerves were removed. Muscular contractions were recorded as changes in the length of the anterior–posterior axis of the isolated demibranchs.

Contractions of the branchial muscles were recorded in either of two ways. (1) Isolated demibranchs were suspended in organ baths and attached with thread to isometric force transducers [Grass FT03 (Grass Instruments Division, Astro-Med, Inc., West Warwick, RI, USA) and UFI 1030 (UFI,

Morro Bay, CA, USA) equipped with springs; the resulting contractions were therefore semi-isotonic. The transducers were interfaced to DA 100 amplifiers and an MP100 analog-to-digital converter (Biopac, Santa Barbara, CA, USA). (2) In one set of experiments, ultrasonic crystal transceivers (Sonometrics, London, Ontario, Canada) were tied to the ends of demibranchs with thread. One end of the demibranch was pinned to a piece of rubber band that was glued with rubber cement to the bottom of a plastic Petri dish (4.7 cm diameter); the Petri dishes were placed on a cooling plate to maintain temperature. Under these conditions, the muscles were unrestrained and contracted against virtually no external load; thus, a single demibranch could be used for an entire dose-response experiment. The isotonic contractions were measured with a digital ultrasonic measurement system (TRX series 8; Sonometrics). In both cases, the magnitude of the contractions was measured with AcqKnowledge version 3.5 (Biopac Systems). All experiments were carried out at 10°C in aerated artificial seawater (ASW; Welsh et al., 1968).

Contraction ratios

Each of a clam's four demibranchs was isolated, suspended in an organ bath and attached to a force transducer. After 15 min of relaxation, each of the demibranchs was exposed to  $2 \times 10^{-5} \text{ mol l}^{-1}$  5HT. After the resulting contractions had leveled off, the baths were flushed and a variable amount of time, dependent upon the specific experiment, elapsed before reapplying the same dose of 5HT. The experimental results are expressed as the ratio between the second and first contractions from the same demibranch and are thus internal contraction ratios (Fig. 2).

In certain experiments, designed to examine the pharmacology of potentiation, it was necessary to pretreat a demibranch with an agent before exposure to 5HT. In this experimental design, one of a pair of inner or outer demibranchs was exposed to an agent (the treated demibranch) while the control was untreated. After a predetermined time, both demibranchs of the pair were exposed to only one dose of 5HT. An external contraction ratio was constructed by dividing the response of the treated demibranch (as a

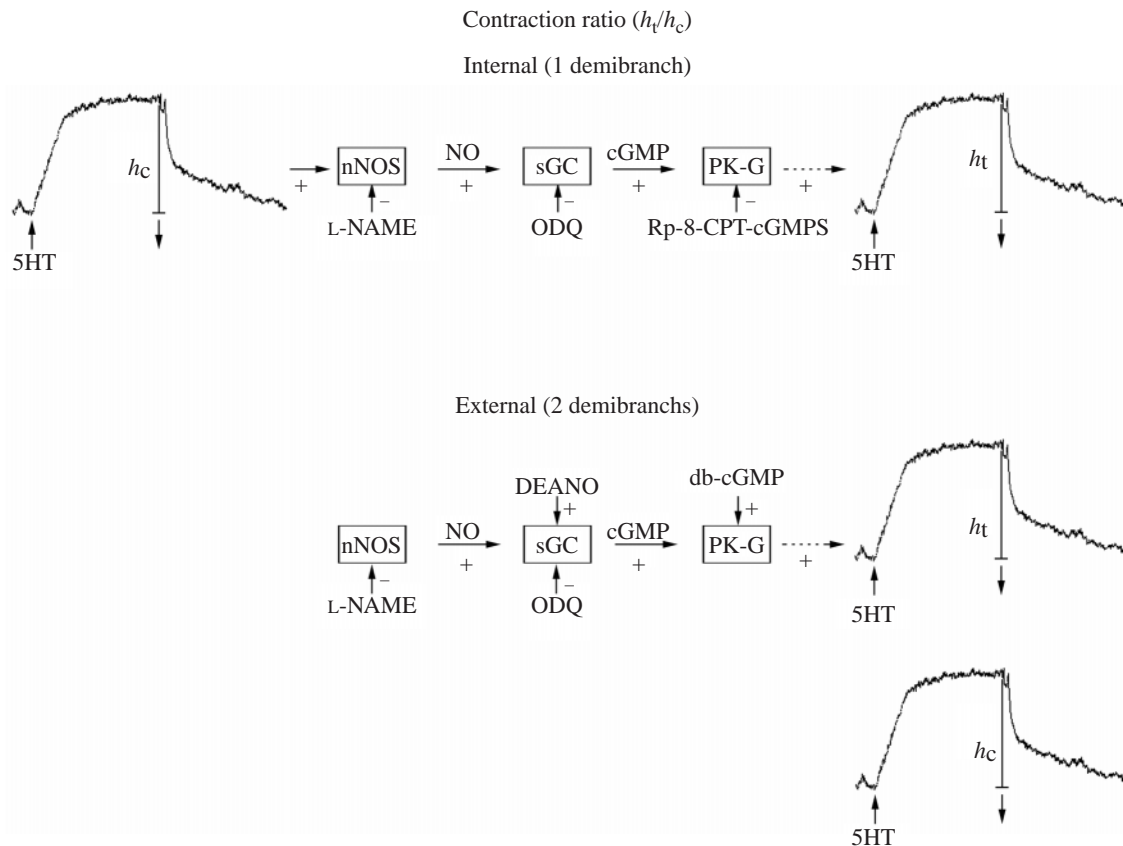

Fig. 2. Experimental designs used to construct internal and external contraction ratios. In general, internal contraction ratios were used to ascertain elements of the signaling pathway leading to potentiation e.g. enzyme inhibitors that block potentiation, whereas external contraction ratios were used to ascertain elements that mimic potentiation e.g. DEANO, and to determine if any of the enzymes are involved in the initial response to 5HT. Traces represent contraction of the gill muscles in response to 5-hydroxytryptamine (5HT; upward arrows) followed by flushing of the organ bath and relaxation of the muscle (downward arrows). The enzymes inferred for the signaling pathway are boxed. -, enzyme inhibitors; +, stimulators;  $h_c$ , height of control contraction;  $h_t$ , height of treatment contraction; nNOS, neuronal nitric oxide synthase; NO, nitric oxide; L-NAME, a NOS inhibitor; sGC, soluble guanylate cyclase; ODQ, a sGC inhibitor; cGMP, cyclic GMP; PKG, protein kinase G; Rp-8-CPT-cGMPS, a PK-G inhibitor; DEANO, an NO generator; db-cGMP, dibutyl cGMP, a cell permeable cGMP analog.

percentage of its initial length) by the response of the control demibranch (again as a percentage of its initial length, Fig. 2).

The internal contraction ratios of untreated controls were analyzed using a Kolmogorov–Smirnov one-sample test, which revealed that these data were not normally distributed ( $P < 0.001$ , two-tailed,  $N = 139$ ). Both internal and external contraction ratios were therefore normalized by a logarithmic transformation. The normality of this transformation was checked as above (Kolmogorov–Smirnov;  $P = 0.614$ ). The  $\ln$ -transformed ratios were tested against a mean of 0 (since  $\ln 1 = 0$ ) with a one-sample  $t$ -test. This is mathematically equivalent to a paired  $t$ -test because the contractions used to construct the ratios were either from the same demibranch or the same clam in the case of external contraction ratios.

Although the statistical tests were performed on the  $\ln$ -transformed data, for clarity in the Results, data in tables and figures are presented untransformed. Depending upon the specific experiment, the  $P$ -values reported for these tests are either two-tailed or one-tailed probabilities and are noted as such in the results;  $P$ -values  $< 0.05$  were considered significant.

#### Exposure times to modulatory agents

The appropriate times for exposure to various agents were determined from the literature and by trial and error at an initial concentration  $10^{-5}$  mol  $l^{-1}$ . The specific times are noted in the Results.

#### Gill anatomy

Isolated demibranchs were allowed to relax overnight at  $5^{\circ}C$  in isotonic  $MgCl_2$  in ASW (7.6%  $MgCl_2$  in distilled water added to an equal volume of ASW). The relaxed demibranchs were then pinned to a small Petri dish, the bottom of which was coated with Sylgard. Demibranchs were fixed overnight in 4% paraformaldehyde in phosphate-buffered saline (0.01 mol  $l^{-1}$  sodium phosphate, 530 mmol  $l^{-1}$  NaCl, pH 7.3; PBS). The fixative was prepared as described in Gainey et al. (1999a). Because mammalian antibodies were used for the immunohistochemistry, subsequent rinses and solutions were made in mammalian PBS (mPBS; 0.1 mol  $l^{-1}$  sodium phosphate, 140 mmol  $l^{-1}$  NaCl, pH 7.3).

After fixation and a 15 min rinse in mPBS, 12  $\mu m$  cryostat sections were prepared. The demibranchs were placed in a solution of 30% sucrose/mPBS overnight at  $5^{\circ}C$ . Pieces of demibranch were then placed in Tissue Tek OCT, frozen and sectioned. Sections were placed on gel-coated slides and stored at  $-20^{\circ}C$  until used.

After fixation and three 15 min rinses in mPBS, 100  $\mu m$  vibratome sections were prepared. Pieces of demibranch were placed in a plastic mold and covered with 12% Type A pigskin gelatin in mPBS, which had been heated to  $50^{\circ}C$ . The tissue was sectioned with the vibratome after the gelatin had cooled. The sections were placed on gel-coated slides and heated briefly at  $50^{\circ}C$  to melt the excess gelatin.

Both cryostat and vibratome sections were processed at  $5^{\circ}C$  and all of the steps are described in detail in Gainey et al. (2003).

Muscles were visualized with phalloidin conjugated to the

fluorescent probe Alexa Fluor 488 (Molecular Probes, Eugene, OR, USA) at a concentration of 1 unit/100  $\mu l$  of mPBS. The phalloidin was added to the tissues at the same time as the secondary antibody.

The primary antibody to NOS was polyclonal, raised in rabbit, and affinity purified (Universal NOS antibody, product number N-217, Sigma-Aldrich, St Louis, MO, USA). The antibody was raised to the synthetic peptide DQKRYHEDIFG, which comprises amino acid residues 1113–1122 of mouse NOS, with an added N-terminal aspartyl residue. Since the antigenic undecapeptide was conjugated to keyhole limpet hemocyanin (KLH) through this N-terminal aspartic acid, and since heterodont clams do not contain hemocyanin, the 5–6 amino acid residues at the free C-terminal of the peptide determined the immunoreactivity of the antibody. When we used BLAST to search in Mollusca for protein sequences with alignments similar to that of the antigenic peptide, the top two results were NOS sequences from *Aplysia californica* (accession number AAK83069) and *Lymnaea stagnalis* (accession number O61039). Both proteins include an 11-residue sequence with the C-terminal sequence –HEDIFG, in the same general location as those in the mouse. Since this hexapeptide is conserved in mouse and two gastropods, and since it is almost certainly the epitope for the universal NOS antibody, we conclude that, in clam gills, the antibody is also detecting NOS. This conclusion was supported by our observation that clam gills subjected to the NADPH-diaphorase technique showed staining comparable to that seen in gills processed with the antibody (L. L. Moroz and B. Untch, unpublished observations). A 1/100 dilution of the antibody with mPBS was used for the images in Fig. 10.

The primary antibody to soluble guanylate cyclase (sGC) was a rabbit polyclonal raised to two antigenic peptides: EQARAQDGLKKRLGKLLKAT (human  $\alpha_1$  residues 414–432) and EDFYEDLDRFEENGQTQDSR (rat  $\beta_1$  residues 188–207); the peptides were both conjugated to KLH (product number 160890; Cayman Chemical, Ann Arbor, MI, USA). A BLAST search revealed that the antigenic  $\alpha$  peptide is similar to  $\alpha$  subunit sGC sequences in both *Drosophila* and *Manduca*; there

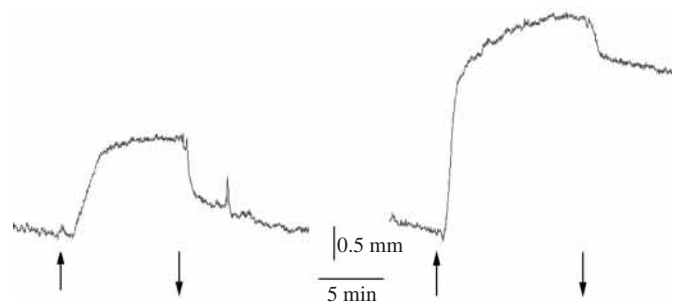

Fig. 3. Contractions of gill muscles in response to  $2 \times 10^{-5}$  mol  $l^{-1}$  5HT (applied at the upward arrows). The response to each dose of 5HT was terminated by flushing the organ bath (at downward arrows). 1 h elapsed between the flush and the addition of the second dose of 5HT.

are no sequence data of sGC in molluscs. A 1/100 dilution of the antibody with mPBS was used for the images in Fig. 10.

The secondary antibody in both instances was a goat anti-rabbit (IgG) conjugated to Alexa Fluor 594 (Molecular Probes); the antibody was used at a 1/200 dilution in mPBS.

Negative controls were made by omitting the primary antibodies from one slide in each series of preparations.

Fluorescent images were made with a Nikon Eclipse TE200 or a Leica DMLB microscope equipped with a Spot RT digital color camera (Diagnostic Instruments, St Sterling Heights, MI, USA). Images were prepared for publication with Adobe Photoshop.

#### Dose-dependent effects

All contractions, measured in mm, were expressed as a percentage of the initial length of each demibranch. Regression lines were fitted with a logistic function of the form:  $\text{response} = \alpha / (1 + \exp[\beta_0 + \beta_1 \times \log(\text{agonist})])$ , where  $\alpha$  is the asymptotic value of the maximal contraction, and  $\beta_0$  and  $\beta_1$  are intercept and slope parameters, respectively. Initially, all three parameters were estimated using non-linear regression (Systat, v. 9 and 10); later  $\alpha$  was fixed in the model, reducing the error estimates of the remaining parameters. The concentrations of agonist giving half-maximal responses ( $EC_{50}$ ) were estimated according to the following formula:  $EC_{50} = 10^{(-\beta_0/\beta_1)}$ .

## Results

### Potentiation

Previously, we reported that the second contraction of demibranchs in response to  $2 \times 10^{-5} \text{ mol l}^{-1}$  5HT is larger than the initial contraction, i.e. the ratio of the second contraction to the first is significantly greater than 1 (Gainey et al., 2003). In physiological terms, the first dose of 5HT potentiates the response of the muscle to the second dose (Fig. 3).

### Duration

In our initial experiments, leading to the discovery of potentiation, the period between the end of the first dose of 5HT (flushing of the organ baths) and the addition of the second dose was 1 h. To study whether the potentiation was time dependent, we varied this period between 15 min and 24 h (Fig. 4). The mean internal contraction ratios, as a measure of potentiation, ranged from a high of  $2.45 \pm 0.69$  ( $\pm$ s.e.m.;  $N=8$ ) at 2 h to a low of  $2.00 \pm 0.45$  ( $N=15$ ) at 24 h; but ANOVA revealed that there were no significant differences amongst any of the times ( $F_{5,178}=0.28$ ;  $P=0.92$ ). These data were collected in the winter.

### Seasonal effects

From data collected over 5 years, monthly mean internal contraction ratios were calculated, and ranged from a high of  $2.94 \pm 0.65$  (mean  $\pm$  s.e.m.;  $N=23$ ) in February to a low of  $0.88 \pm 0.12$  ( $N=30$ ) in October. Moreover, when these monthly means were plotted, a clear seasonal component to potentiation was revealed (Fig. 5). From November through June, the

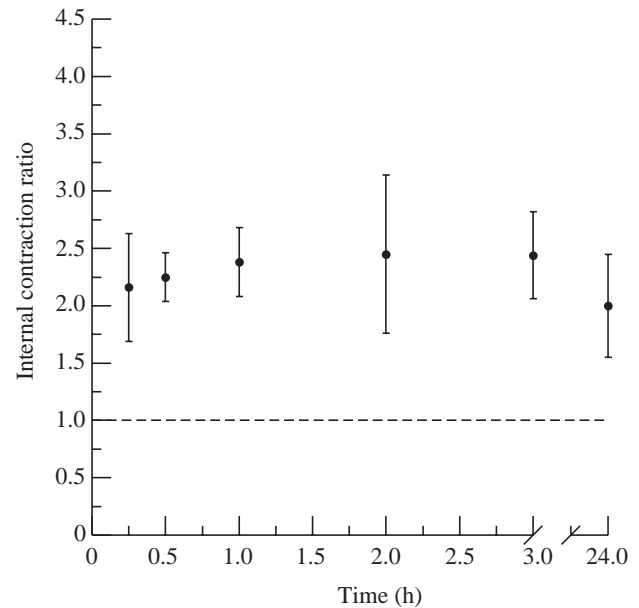

Fig. 4. Effect on the internal contraction ratio of the length of time between the first flush of the organ bath and the addition of the second dose of  $2 \times 10^{-5} \text{ mol l}^{-1}$  5HT. Note the scale break between 3 and 24 h. Values are means  $\pm$  1 s.e.m.,  $N=18$  (15 min), 98 (30 min), 41 (60 min), 8 (2 h), 4 (3 h), 15 (24 h).

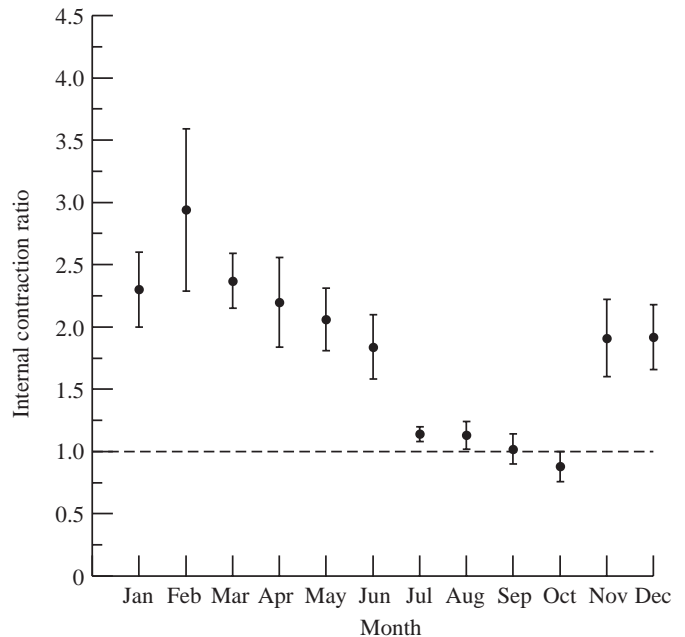

Fig. 5. Monthly variation in a five-year set of mean internal contraction ratios in response to  $2 \times 10^{-5} \text{ mol l}^{-1}$  5HT. Each demibranch was exposed twice to 5HT with a 30 min or 1 h period of relaxation between exposures; the internal contraction ratio is the second response/initial response for each demibranch. Values are means  $\pm$  1 s.e.m.,  $N=14$  (Jan), 23 (Feb), 51 (Mar), 35 (Apr), 39 (May), 46 (June), 80 (July), 39 (Aug), 32 (Sept), 30 (Oct), 17 (Nov), 13 (Dec).

period of potentiation, all of the mean internal contraction ratios were equal to each other ( $F_{7,226}=1.845$ ;  $P=0.08$ ) and

significantly greater than 1 (one-tailed  $P < 0.001$ ). From July through October, the season of no potentiation, the mean internal contraction ratios were again equal to each other ( $F_{3,177} = 2.36$ ;  $P = 0.06$ ), but they were not different from 1 (two-tailed,  $P = 0.07$ ).

#### Geographic effects

Because the clams used in our experiments all came from the northeastern USA, we wondered if geographical origin affected potentiation. To answer this question, we compared the internal contraction ratios of northern clams to those of Florida clams; comparisons were made in July and August, when potentiation was absent, and in March, when potentiation was present. In neither case, was there a statistical difference between northern and Florida clams (Table 1).

#### Acclimation temperature and geography

In the previous experiments, the northern clams were maintained at 10°C while the Florida clams were kept at 20°C, so we tested whether the acclimation temperature affected the internal contraction ratios. In March, we acclimated clams from Maine and Florida to temperatures of both 10°C and 20°C for 1 week and compared the mean internal contraction ratios using a two-way ANOVA. Neither geographic region nor

Table 1. Comparison of mean internal contraction ratios (ICR) between northern and Florida clams in July/August (summer) and March (winter)

Season	Region	ICR	S.E.M.	N	P
Summer	North	1.17	0.11	34	0.17
Summer	Florida	1.37	0.20	18	
Winter	North	2.51	0.39	16	
Winter	Florida	2.32	0.47	12	

Northern clams were acclimated to 10°C and Florida clams to 20°C for both seasons.

S.E.M., standard error of mean;  $P$  = two-tailed probability.

Table 2. The effects of geographic origin and acclimation temperature on the mean internal contraction ratios

Region	Month	Acclimation temperature (°C)	ICR	S.E.M.	N
Florida	March	20	2.32	0.47	12
		10	2.57	0.65	11
Maine	March	20	2.06	0.24	12
		10	2.51	0.39	16
Massachusetts	September	20	1.12	0.14	21
		10	1.02	0.12	19

ICR, mean internal contraction ratio.

For the clams tested in March, the ICRs are equal – see text for  $P$  values from two-way ANOVA.

For the clams tested in September, the ICRs are also equal to each other.

S.E.M., standard error of mean; two-tailed  $P = 0.11$ .

acclimation temperature was significant ( $F_{1,47} = 0.1, 0.17$ ;  $P = 0.76, 0.68$ , respectively; Table 2). Moreover, we acclimated clams from Massachusetts to temperatures of 10°C and 20°C for 1 week in September and compared the internal contraction ratios, and again there was no significant difference (two-tailed  $P = 0.11$ ; Table 2).

#### Nitric oxide mediates potentiation

To test if potentiation was mediated by nitric oxide (NO), we performed the following experiments and immunohistochemical observations. (1) We inhibited nitric oxide synthase (NOS) with L-NAME (nitro-L-arginine methyl ester); (2) pretreated gills with the NO donor DEANO (diethylamine/nitric oxide complex); and (3) prepared gill sections were exposed to the universal NOS antibody.

#### Inhibition of NOS

In May, when potentiation was present, we exposed demibranchs to the NOS inhibitor L-NAME for 15 min before the second exposure to 5HT. Potentiation was abolished at L-NAME concentrations of  $10^{-6}$ ,  $10^{-5}$  and  $10^{-4}$  mol l<sup>-1</sup>, and none of these mean internal contraction ratios were significantly different from 1 (Fig. 6). At lower concentrations of L-NAME ( $10^{-8}$ ,  $10^{-7}$  mol l<sup>-1</sup>), the mean internal contraction ratios were not significantly different from those of control clams (two-tailed  $P = 0.14$  at  $10^{-8}$  mol l<sup>-1</sup>;  $P = 0.46$  at  $10^{-7}$  mol l<sup>-1</sup>; internal contraction ratio of controls =  $2.72 \pm 0.44$ , mean  $\pm$  S.E.M.;  $N = 15$ ). As an additional control, gills were exposed to the inactive enantiomer D-NAME, at  $10^{-4}$  mol l<sup>-1</sup>; the internal contraction ratio was  $2.04 \pm 0.32$  (mean  $\pm$  S.E.M.,  $N = 5$ ), which was not significantly different from that of untreated controls (two-tailed  $P = 0.48$ ) (not shown).

In the previous experiments, potentiation was studied at  $2 \times 10^{-5}$  mol l<sup>-1</sup> 5HT. But is the magnitude of potentiation dependent upon the concentration of 5HT? To answer this question, we used paired demibranchs from the same clams: one demibranch was exposed to  $10^{-5}$  mol l<sup>-1</sup> L-NAME to block potentiation, then both demibranchs were exposed to increasing concentrations of 5HT. The responses were measured with ultrasound, which minimized fatigue, thus a single demibranch could be used for an entire dose-response curve. The control demibranchs would show the effects of both 5HT and NO, because they were exposed to multiple, increasing doses of 5HT; while the demibranchs pre-treated with L-NAME would show only the effects of 5HT. At 5HT concentrations below  $5 \times 10^{-6}$  mol l<sup>-1</sup>, the responses of both treatment and control demibranchs were indistinguishable. At concentrations of  $5 \times 10^{-6}$  mol l<sup>-1</sup> 5HT and above, the data and the regression lines diverge. The data and the curve for the demibranchs treated with L-NAME lie below those of the control demibranchs, and the statistically significant difference between the control and treatment lines is the contribution of NO to the effects of 5HT ( $F_{1,52} = 100$ ;  $P < 0.001$ ; Fig. 7). Thus, the amount of potentiation is dependent upon the dose of 5HT.

The two previous experiments suggest that the potentiation of the second response to 5HT is mediated by NO. But does

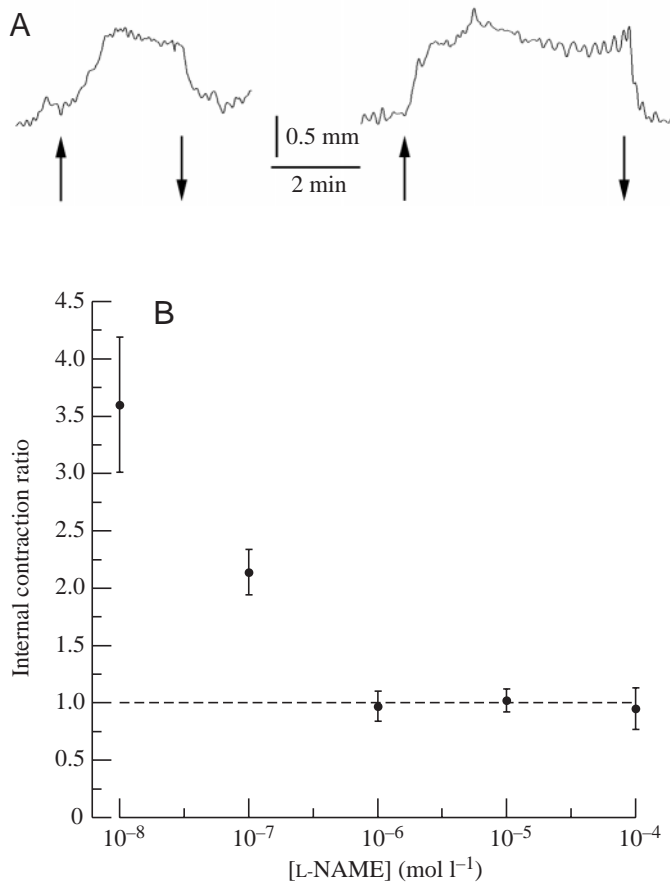

Fig. 6. The effect of L-NAME on internal contraction ratios. (A) Contractions of the same demibranch in response to  $2 \times 10^{-5}$  mol l<sup>-1</sup> 5HT (applied at the upward arrows). The response to each dose of 5HT was terminated by flushing the organ bath (downward arrows). L-NAME ( $10^{-4}$  mol l<sup>-1</sup>) was applied for 15 min before the second contraction. The resulting internal contraction ratio was 0.92. (B) Various concentrations of L-NAME were applied to isolated demibranchs for 15 min between their first and second contractions in response to  $2 \times 10^{-5}$  mol l<sup>-1</sup> 5HT. Values are means  $\pm$  1 S.E.M.,  $N=3$  for all concentrations of L-NAME except  $10^{-4}$  mol l<sup>-1</sup> where  $N=4$ .

NO also contribute to the initial response to 5HT? In January, when potentiation was present, we pretreated one demibranch of each pair with L-NAME for 15 min, and then exposed both demibranchs to  $2 \times 10^{-5}$  mol l<sup>-1</sup> 5HT. The resulting external contraction ratios decreased markedly (Fig. 8); indeed, for 5HT doses from  $10^{-9}$  to  $10^{-4}$  mol l<sup>-1</sup> the pooled external contraction ratio =  $0.73 \pm 0.05$  (mean  $\pm$  S.E.M.;  $N=27$ ) was significantly less than 1 (one-tailed  $P < 0.001$ ), and these values were equal to each other ( $F_{5,19} = 0.27$ ;  $P = 0.92$ ). The external contraction ratio at  $10^{-10}$  mol l<sup>-1</sup> L-NAME was  $0.96 \pm 0.10$  (mean  $\pm$  S.E.M.;  $N=3$ ), which was not significantly different from 1 (two-tailed  $P = 0.64$ ). As a control, gills were pretreated with  $10^{-5}$  mol l<sup>-1</sup> D-NAME, and the resulting external contraction ratios were not significantly different from 1 ( $1.11 \pm 0.23$ , mean  $\pm$  S.E.M.;  $N=6$ ; two-tailed  $P = 0.87$ ). Finally, we repeated the experiment in

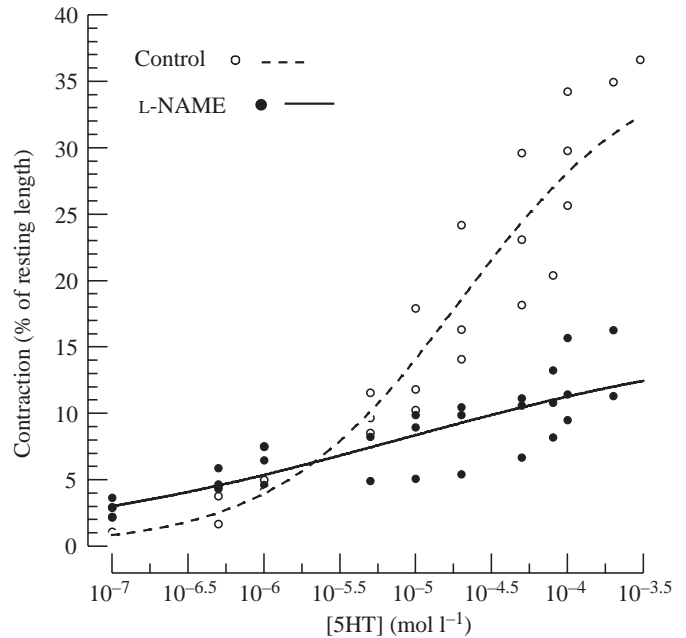

Fig. 7. The effect of L-NAME on dose-dependent muscle contraction (as a percentage of resting length) in response to 5HT. Treatment demibranchs (solid circles/solid line) were exposed to  $1 \times 10^{-5}$  mol l<sup>-1</sup> L-NAME for 15 min, and then both treatment and control demibranchs (open circle/broken line) were exposed to increasing concentrations of 5HT. Data were recorded using ultrasound, which allowed a single demibranch to be used for an entire dose-response curve. Data consist of paired demibranchs (three treatments, three controls) from three clams.

August, when potentiation was absent, with  $10^{-5}$  mol l<sup>-1</sup> L-NAME, and there was no significant effect upon the external contraction ratio ( $1.10 \pm 0.19$ , mean  $\pm$  S.E.M.;  $N=10$ ; two-tailed  $P = 0.77$ ; Fig. 8).

#### Effect of an NO donor

To confirm the results of the experiments with L-NAME, we pretreated one of each pair of inner and outer demibranchs for 5 min with the NO donor DEANO. To retard the oxidation and degassing of NO, all of the demibranchs were suspended in degassed non-aerated seawater. Then we exposed all of the demibranchs to  $2 \times 10^{-5}$  mol l<sup>-1</sup> 5HT; thus, external contraction ratios were calculated in this experiment. Nitric oxide, released by DEANO, increased the external contraction ratios in a dose-dependent manner (Fig. 9). The threshold of the response was at  $10^{-13}$  mol l<sup>-1</sup>. At concentrations of DEANO greater than  $10^{-10}$  mol l<sup>-1</sup>, all of the external contraction ratios were significantly greater than 1.

The experiments shown in Fig. 9 were performed in the late fall, during the season of potentiation. In July, when potentiation was absent, we repeated these experiments with  $10^{-5}$  mol l<sup>-1</sup> DEANO, a concentration that had potentiated contractions in the fall. The external contraction ratio (mean  $\pm$  S.E.M.) was  $1.05 \pm 0.085$ ;  $N=15$ , which was not significantly different from a mean of 1 (two-tailed  $P = 0.99$ ); in other words,

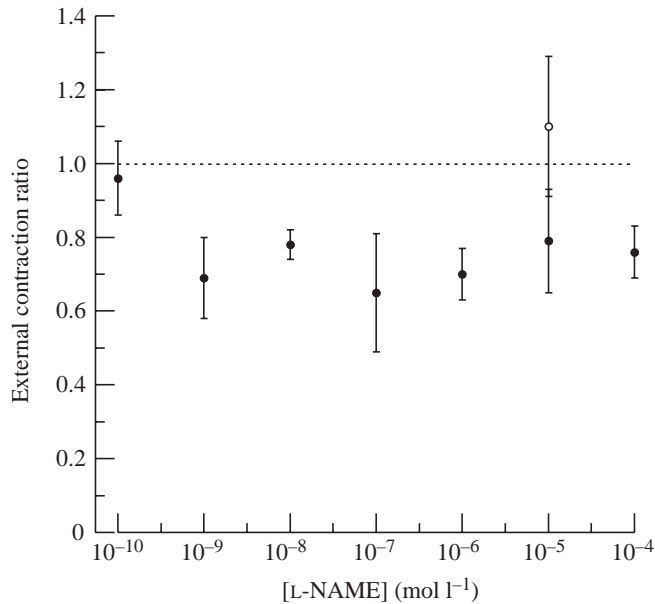

Fig. 8. The effect of L-NAME on mean external contraction ratios. In this experiment, one demibranch was exposed to L-NAME for 15 min prior to exposure to  $2 \times 10^{-5} \text{ mol l}^{-1}$  5HT, while the control demibranch was only exposed to  $2 \times 10^{-5} \text{ mol l}^{-1}$  5HT. The open circle represents data collected in August, when potentiation is absent. Values are means  $\pm 1$  S.E.M.,  $N=3-10$ .

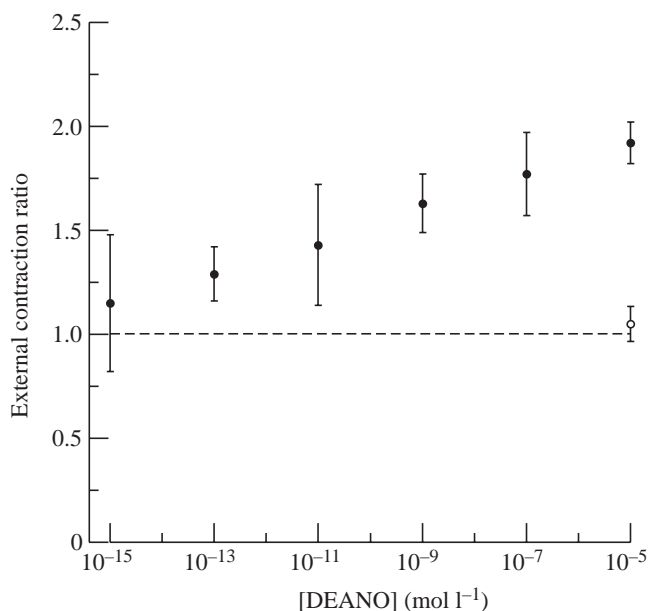

Fig. 9. Mean external contraction ratios in response to an NO donor, DEANO. The treatment demibranchs (numerator) were exposed first to DEANO, and then to  $2 \times 10^{-5} \text{ mol l}^{-1}$  5HT, while the control demibranchs (denominator) were only exposed to  $2 \times 10^{-5} \text{ mol l}^{-1}$  5HT. The open circle represents data collected in July, when potentiation is absent. Values are means  $\pm 1$  S.E.M.,  $N=3-15$  at each concentration of DEANO.

DEANO had no effect on 5HT induced contractions (Fig. 9, open circle).

#### NOS immunohistochemistry

Our pharmacological data indicated that NOS should be found in the gill. We examined thick sections ( $100 \mu\text{m}$ ) of gills removed from clams in November when potentiation is present, and found immunoreactive (ir) NOS to be concentrated in the longitudinal muscles, the muscles of the blood vessel and septa, and the epithelium of the gill filaments (Fig. 10A,B). Little ir-NOS was seen in the water tube muscles. However, in July and August, when potentiation is absent, thin and thick sections of gills showed NOS concentrated only at the base of the gill filaments and in varicose fibers adjacent to the gill muscle (Fig. 10C,D). The enzyme was also unevenly distributed within the horizontal blood vessels and subfilamentar tissues (Fig. 10C). Moreover, the thin section (Fig. 10D) was made from Florida clams in July, 2001, while the thick section (Fig. 10C) was made from Massachusetts clams in August, 2002. Negative controls, lacking the primary antibody, had low levels of background fluorescence comparable to the tips of the filaments in Fig. 10C.

#### Signal transduction

Because NO exerts at least some of its effects by stimulating soluble guanylate cyclase (sGC) and thereby increasing the concentration of cGMP, we tested the effects of the membrane permeable cGMP analog db-cGMP (dibutyl cyclic GMP) on branchial muscle contraction. The experimental design was that used in the experiments with DEANO: one of each pair of demibranchs was pretreated with db-cGMP for 15 min then both demibranchs were then exposed to  $2 \times 10^{-5} \text{ mol l}^{-1}$  5HT, and external contraction ratios calculated. db-cGMP increased the external contraction ratios in a dose-dependent manner, and the threshold was between  $10^{-9}$  and  $10^{-8} \text{ mol l}^{-1}$  (Fig. 11). These experiments were performed in November and December, during the season of potentiation.

To test further the hypothesis that NO augments branchial muscle contraction by stimulating sGC, we exposed gills to increasing concentrations of the sGC inhibitor ODQ (oxadiazoloquinoxalin) for 60 min between the first and second contractions. ODQ inhibited potentiation in a dose-dependent manner (Fig. 12). The internal contraction ratio at  $10^{-4} \text{ mol l}^{-1}$  ODQ was significantly lower than that of untreated controls (one-sample  $P=0.019$ ), but the ratio was still significantly greater than 1 (one-sample  $P<0.001$ ).

Because we could not completely abolish potentiation with ODQ in the previous experiment, we wondered if some of the effects of NO were direct *via* S-nitrosylation of effector proteins. Therefore, we pretreated one of each pair of demibranchs with  $10^{-6} \text{ mol l}^{-1}$  DEANO (a concentration sufficient to elicit potentiation) and with increasing concentrations of ODQ (at the time we performed this experiment, we were not aware that NO potentiated the initial contraction, hence we added the DEANO). Then we exposed



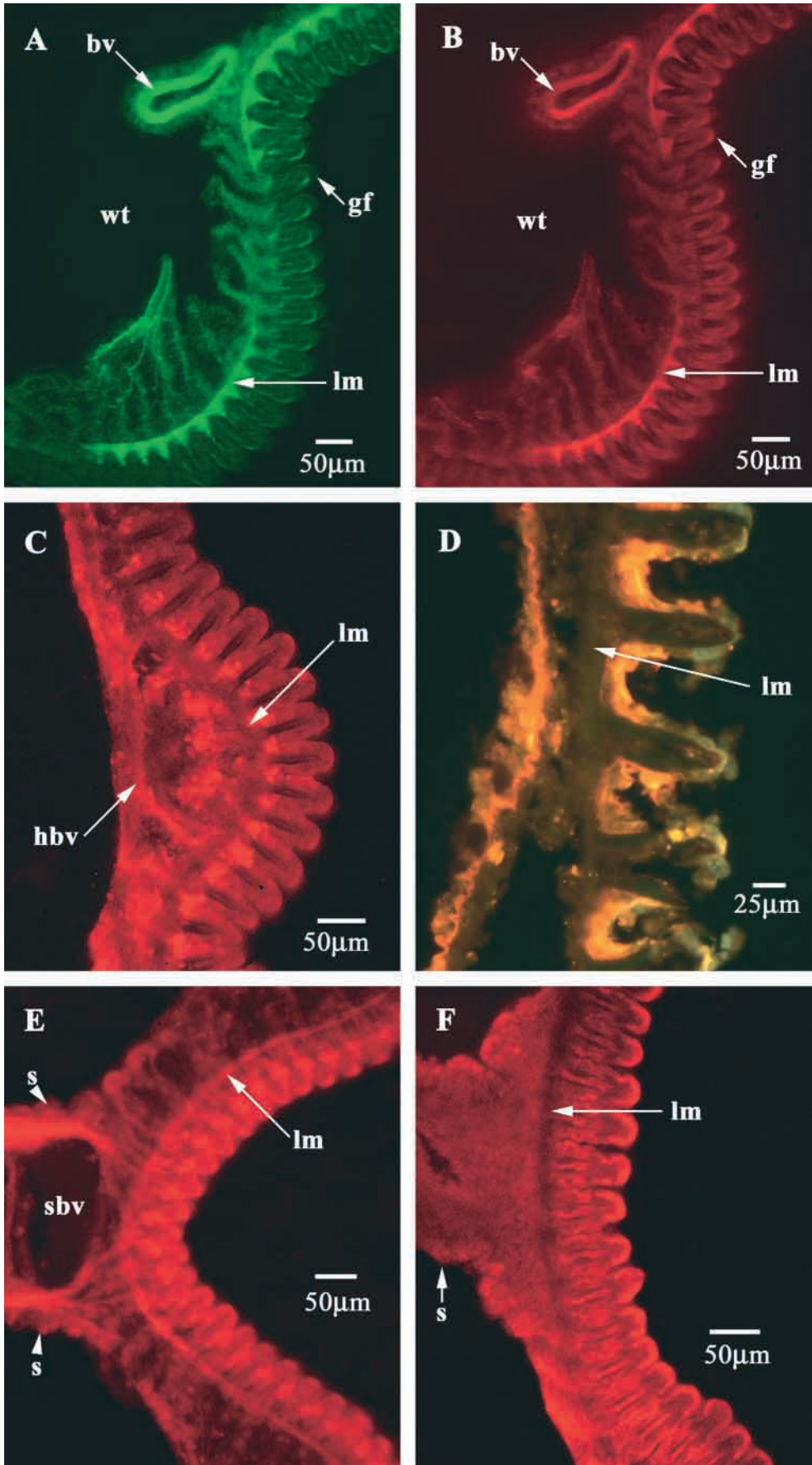

Fig. 10. Seasonal variation in the distribution of nitric oxide synthase (NOS) and soluble guanylate cyclase (sGC) in the gills of *Mercenaria mercenaria*. (A) Thick (100  $\mu\text{m}$ ) section; muscle fibers visualized with green-fluorescing phalloidin. Muscle is concentrated in the longitudinal muscle (lm), which also sends branches into each gill filament (gf); muscle also occurs in the major blood vessel (bv). (B) The same section as A but visualized with a filter for red fluorescence showing the distribution of immunoreactive (ir) NOS. This section was made in November (early in the season of potentiation) in gills from a Massachusetts clam. (C) Thick section showing the distribution of NOS in a gill taken from a Massachusetts clam in August (no potentiation) 2002. (D) Thin section (12  $\mu\text{m}$ ) showing the distribution of NOS in a gill taken from a Florida clam in July (no potentiation) 2001. Note the intense ir-NOS at the base of the gill filaments and in varicose fibers adjacent to the longitudinal muscle. (E) Thick section of a gill in April (potentiation) showing the distribution of ir-sGC, which is concentrated in the longitudinal and septal muscles and the gill filaments. (F) Thick section of a gill in August showing the distribution of ir-sGC, which is concentrated in the gill filaments and, to a lesser extent, in the projections of the longitudinal muscle in the gill filaments. Note the lack of fluorescence in the main body of the longitudinal muscles. All thick sections are 100  $\mu\text{m}$ . hbv, horizontal blood vessel; s, septum; sbv, septal blood vessel; wt, water tube. Scale bars, 50  $\mu\text{m}$  (except for D, 25  $\mu\text{m}$ ).

the treated and control gills to  $2 \times 10^{-5} \text{ mol l}^{-1}$  5HT. External contraction ratios were calculated as usual. ODQ inhibited the potentiation induced by DEANO (Fig. 13). The mean external

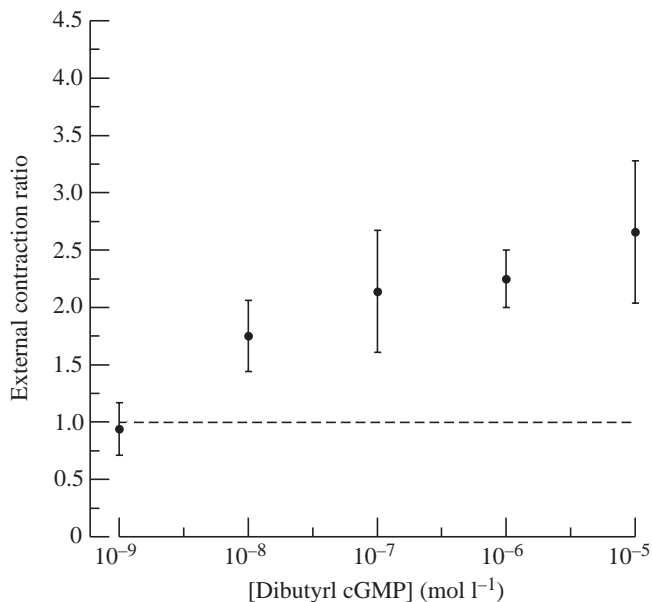

Fig. 11. Mean external contraction ratios in response to the membrane permeable cGMP analog, dibutyl cGMP. The treatment demibranchs (numerator) were exposed to dibutyl cGMP and then to  $2 \times 10^{-5} \text{ mol l}^{-1}$  5HT, while the control demibranchs (denominator) were only exposed to  $2 \times 10^{-5} \text{ mol l}^{-1}$  5HT. Values are means  $\pm$  1 S.E.M.,  $N=8$  for each concentration of dibutyl cGMP.

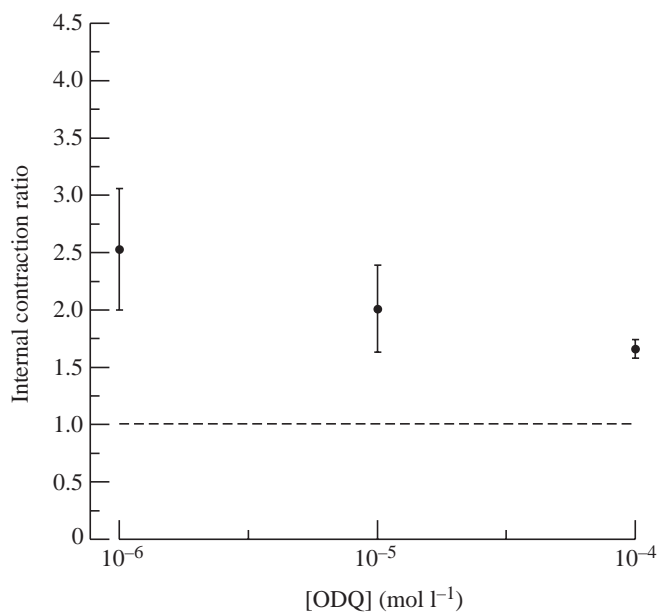

Fig. 12. Mean internal contraction ratios in response to the membrane permeable guanylate cyclase inhibitor ODQ. ODQ was added between the first and second contractions in response to  $2 \times 10^{-5} \text{ mol l}^{-1}$  5HT. Values are means  $\pm$  1 S.E.M.,  $N=6$  for each concentration of ODQ.

contraction ratios at  $10^{-8}$ ,  $10^{-7}$  and  $10^{-6} \text{ mol l}^{-1}$  ODQ were equal to each other ( $F_{2,12}=0.137$ ;  $P=0.87$ ) and significantly greater than 1 (one-tailed  $P=0.004$ ). In contrast, the mean external contraction ratios at  $10^{-5}$  and  $5 \times 10^{-5} \text{ mol l}^{-1}$  ODQ were not significantly different than 1 (two-tailed  $P=0.63$  and 0.93, respectively). In summary, we could completely inhibit NO-induced potentiation by inhibiting sGC.

To test whether cGMP affects potentiation directly, i.e. by activating a cGMP-gated channel or by stimulating a protein kinase G (PK-G), we treated gills with the PK-G inhibitor Rp-8-CPT-cGMPS ( $10^{-5} \text{ mol l}^{-1}$ ; Rp-8-[(4-chlorophenyl)thio]guanosine 3',5'-cyclic monophosphothioate) for 5 min between the first and second contractions. The mean internal contraction ratio for treated demibranchs was  $1.06 \pm 0.15$  ( $\pm$  S.E.M.;  $N=12$ ), which was significantly less than the control contraction ratio of  $2.01 \pm 0.51$  (mean  $\pm$  S.E.M.;  $N=9$ ; one-tailed  $P=0.02$ ) (not shown).

#### sGC immunohistochemistry

Thick sections of demibranchs from clams in April showed ir-sGC concentrated in the gill musculature and the gill filament epithelium (Fig. 10E). In contrast, demibranchs taken from clams in August, when potentiation was absent, had no sGC in the main body of the longitudinal muscle, but the enzyme was still present in the gill filament epithelium and in branches of the longitudinal muscles running into the center of each filament (Fig. 10F).

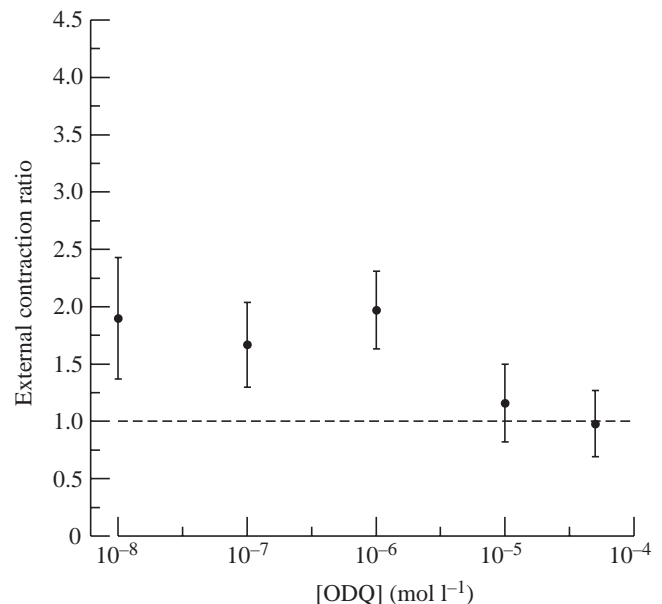

Fig. 13. Mean external contraction ratios in response to the membrane permeable guanylate cyclase inhibitor ODQ. Treatment demibranchs (numerator) were exposed to  $10^{-6} \text{ mol l}^{-1}$  DEANO and varying concentrations of ODQ and then to  $2 \times 10^{-5} \text{ mol l}^{-1}$  5HT, while the control demibranchs (denominator) were only exposed to  $2 \times 10^{-5} \text{ mol l}^{-1}$  5HT. Values are means  $\pm$  1 S.E.M.,  $N=6-4$  at each concentration of ODQ.

Seasonal 5HT dose-response data

Because potentiation and the distributions of NOS and sGC vary seasonally, we expected that a 5HT dose-response curve produced with demibranchs from summer clams would lie to the right of a curve produced with winter clams. That is, in the summer (the season of no potentiation), muscles would be less sensitive to 5HT. We therefore constructed a dose-response curve to 5HT during July and August and compared it to one previously, and fortuitously, produced during the winter (Gainey et al., 2003). Unexpectedly, the dose-response curve of summer gills lies to the left of that from winter gills, and the regression lines are significantly different ( $F_{1,103}=22$ ;  $P<0.001$ ; Fig. 14). The  $EC_{50}$  for the line of summer is  $3.8 \times 10^{-5} \text{ mol l}^{-1}$  (95% CI= $1.8 \times 10^{-5}$  to  $5.8 \times 10^{-5} \text{ mol l}^{-1}$ ) whereas, that for the winter is  $1.1 \times 10^{-4} \text{ mol l}^{-1}$  (95% CI= $4.0 \times 10^{-5}$  to  $1.8 \times 10^{-4} \text{ mol l}^{-1}$ ).

Finally, using the data set for seasonal potentiation (Fig. 5), we plotted, for each month, the mean response of the demibranchs to their first exposure to  $2 \times 10^{-5} \text{ mol l}^{-1}$  5HT. The mean response was measured as a fraction of the initial length of the demibranch. One-way ANOVA revealed that the mean monthly contractions were significantly different ( $F_{11,338}=11.29$ ;  $P<0.001$ , Fig. 15). The responses are lowest in February and rise incrementally to their maximum in July. March, however, appears to be an outlier, because the mean response in this month is as large as that in June. But close inspection of the data from March suggests that the magnitude

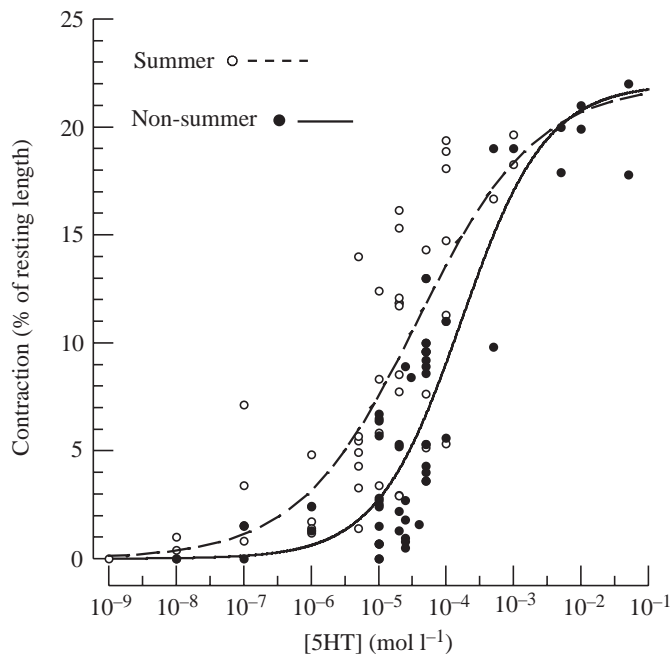

Fig. 14. Dose-dependent muscle contraction (as a percentage of the resting length) in response to 5HT. Each point is the response of a separate demibranch. Open circles/broken line: data collected in July and August. Solid circle/solid line: data collected between December and May.

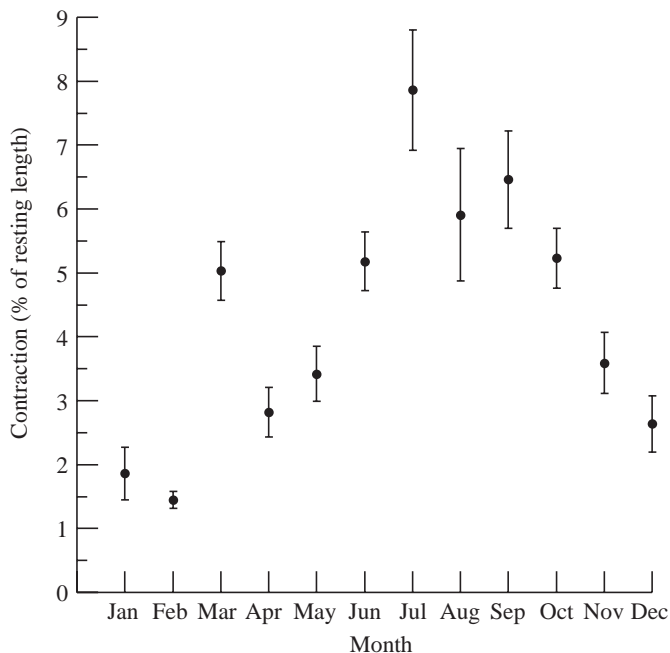

Fig. 15. Monthly dependence of the response to  $2 \times 10^{-5} \text{ mol l}^{-1}$  5HT. Means are the response of demibranchs to an initial exposure to  $2 \times 10^{-5} \text{ mol l}^{-1}$  5HT. Values are means  $\pm$  1 S.E.M. Sample sizes are the same as Fig. 4.

of these responses is not a sampling artifact. In particular, the data for this month includes the responses of both northern clams (% contraction= $4.99$ ; mean  $\pm$  S.E.M.= $0.63$ ;  $N=30$ ) and Florida clams (% contraction= $5.09 \pm 0.69$ , mean  $\pm$  S.E.M.;  $N=24$ ) and they are clearly similar.

Discussion

We have shown conclusively that the first application of 5HT to isolated gills potentiates the response of the gill musculature to succeeding applications of the same dose of this transmitter. Furthermore, this potentiation persists *in vitro* for 24 h. However, we have also discovered that the potentiation is seasonal, being present from November through June, and absent from July through October. We have also demonstrated that the potentiation is abolished when NOS is inhibited and is mimicked when the gill is treated with a nitric oxide donor. These findings, together with pharmacological studies of signal transduction, support our hypothesis that potentiation is mediated by a NO/cGMP/PK-G signaling pathway. Finally, the immunohistochemical localization of NOS and sGC varied seasonally, being present within the longitudinal muscles during the season of potentiation, and absent during the off season.

Potentiation

Time course

The potentiation reported here is particularly striking because it was maintained for up to 24 h in isolated gills, and

the magnitudes of potentiation observed between 15 min and 24 h were equal. Similar potentiations, induced by prior stimulation or related to the contraction history of the muscle, have been observed in a variety of vertebrate muscles, including skeletal (Rosenthal, 1969), cardiac (Hare and Stamler, 1999) and airway smooth muscle (Gunst et al., 1993; Meiss, 1997). Long-term potentiation of the buccal muscles of the gastropod mollusc *Aplysia* has also been extensively studied (Cropper et al., 1987a,b, 1990). But in most of these cases, potentiation only lasts from seconds to minutes (see previous references and Decostre et al., 2000; Pilarski and Brechue, 2002), which is much shorter than the potentiation of the gill muscle seen in the present work.

#### *Seasonality, geography, and acclimation temperature*

The seasonality of potentiation is another of its notable aspects, and we supposed that it would vary with the source of the experimental animals or the temperature of their acclimation. However, neither the origin of the clams (New England *versus* Florida) nor their acclimation temperature had any effect upon potentiation.

Because potentiation was absent from July through October, we expected that the sensitivity of branchial muscles to 5HT would also be lowest in the late summer to early fall. In fact, although the size of the responses to single doses of 5HT ( $2 \times 10^{-5}$  mol l<sup>-1</sup>) are strongly seasonal, the largest occur in the summer (compare Figs 4 and 13); and therefore, 5HT dose-response curves constructed in the summer lie to the left of those produced in the winter (Fig. 12). In contrast to the gill muscle, the heart of *Mercenaria* is least sensitive to 5HT (by about an order of magnitude) from late June through August (Greenberg, 1960). Finally, we previously reported that the lateral cilia of *Mercenaria* gills are less sensitive to inhibition by dopamine from April to June (Gainey et al., 1999a). Thus, although pharmacological seasonality is common, its timing seems to vary from tissue to tissue.

The reproductive cycle of *Mercenaria* has been studied extensively with respect to temperature and geography. Thus spawning varies with water temperature, and there is a latitudinal gradient, with Florida clams spawning in March (and a second time in the fall) and New England clams spawning once in August. But when Massachusetts and South Carolina clams were crossed, a genetic component to the spawning time was revealed. In addition, the time of spawning could only be altered by a cyclic change in temperature, and this procedure is effective only at certain times of the year (Knaub and Eversole, 1988; for an extensive review, see Eversole, 2001). Finally, potentiation and the other neuropharmacological changes may be part of an endogenous cycle. An amazing example of such a cycle was found in the pulmonate *Otala lactea*. Gainer (1972) found that snails in diapause, under constant laboratory conditions, would spontaneously emerge in April, crawl about for several days, and then return to a dormant state until the next April. These complex phenomena indicate that there may well be geographical or physiological differences in the seasonality of

potentiation and sensitivity that our experiments were unable to resolve.

#### *Nitric oxide mediates potentiation*

Our experiments provide convincing evidence that potentiation is mediated by NO. First, the NO donor DEANO had, by itself, no effect on the gill muscle; i.e. the effects of NO were only apparent after the muscle was stimulated with 5HT. Therefore, NO has no direct effect upon muscle contraction. Second, when we pretreated gills with the NOS inhibitor L-NAME, the response to a first dose of 5HT was inhibited. Therefore, the initial exposure to 5HT generates NO, which then potentiates the initial contraction. Finally, if L-NAME was applied before the second dose of 5HT, the resulting contraction was not potentiated. Therefore, NO must be produced during both the first and the second contractions if the second one is to be potentiated.

#### *Signal transduction*

Our results indicate that the effects of NO-mediated potentiation are *via* the stimulation of sGC because potentiation is inhibited by the SGC inhibitor ODQ in a dose-dependent manner. Additionally, the cGMP analog dibutyryl cGMP mimicked the effects of potentiation. In some systems, e.g. vertebrate photoreceptors, cGMP interacts directly with membrane ion channels, leading to a change in ionic conductance, while in other systems the effects of cGMP are elicited through stimulation of a PK-G, leading to phosphorylation of target proteins (see references cited in the Introduction). That the PK-G inhibitor RP-8-CPT-cGMPS inhibited potentiation implies that potentiation is *via* the latter pathway, i.e. stimulation of a PK-G.

#### *Seasonality of NO mediation and signal transduction*

The expression of immunoreactive NOS is seasonal, and the pattern of seasonality is identical to that of potentiation. Thus, in November, when potentiation occurs, NOS was clearly present within the gill musculature; but in July and August, during the off-season, NOS was not expressed in the muscle, but appeared at the base of the gill filaments adjacent to the muscle. The distance between the muscle and the base of the filaments is about 25  $\mu$ m, so NO can certainly diffuse into the muscle. Moreover, when we pretreated gills with the NO generator DEANO in July, there was no potentiation. Finally, these observations are consistent with our observation that the expression of immunoreactive sGC also varies seasonally; this enzyme is not detectable in the muscle during the summer.

#### *The mechanism of potentiation*

Although we understand the basic signaling mechanism involved in potentiation (Fig. 16), we do not totally understand its underlying causes. Clearly NO modulates force production in the gill musculature, but it is not clear how the initial exposure to 5HT potentiates subsequent exposures to that transmitter. Two sets of our experiments suggest that increased activity of both NOS and sGC occurs following the initial

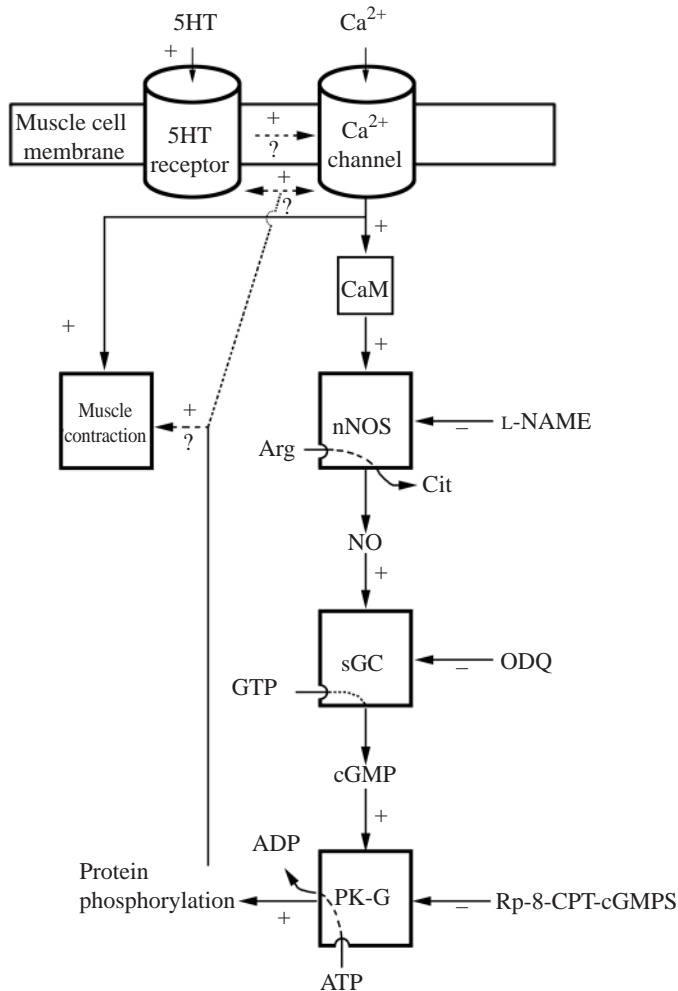

Fig. 16. Model depicting the signal transduction events leading to potentiation of gill muscle contraction. The coupling between the 5HT receptor is unknown, possibly *via* a G protein or the receptor being part of a calcium channel. The presence of calcium channels is inferred because the calcium channel blocker verapamil inhibits contraction (L. F. Gainey, personal observation). The existence of a neuronal-like NOS activated by calmodulin is based upon sequence data (L. L. Moroz and B. Untch, personal communication). The protein target(s) of phosphorylation by protein kinase G (PK-G) are also unknown, but based upon data from other molluscs, the target may be an L-type calcium channel, but the 5HT receptors or contractile proteins may also be phosphorylated. -, enzyme inhibitors; + stimulators; ?, uncertainty (also broken lines). CaM, calmodulin; nNOS, neuronal-like nitric oxide synthase; NO, nitric oxide; cGMP, cyclic GMP.

exposure to 5HT. In the experiments with the NOS inhibitor L-NAME, potentiation was inhibited by  $10^{-9}$  mol l<sup>-1</sup> L-NAME during the initial exposure to 5HT. In contrast, a higher concentration of L-NAME ( $10^{-6}$  mol l<sup>-1</sup>) was needed to inhibit potentiation during the second exposure to 5HT (compare Figs 8 and 6, respectively). These experiments imply that there is increased NOS activity during the second exposure to 5HT. In the second set of analogous experiments with the sGC

inhibitor ODQ, potentiation was inhibited by  $10^{-5}$  mol l<sup>-1</sup> ODQ during the initial exposure to 5HT. In contrast, we could not completely inhibit potentiation with  $10^{-4}$  mol l<sup>-1</sup> ODQ during the second exposure to 5HT (compare Figs 13 and 12, respectively). Again, there is an implication of increased sGC activity during the second exposure to 5HT. These data do not preclude changes in the activity of PK-G, phosphodiesterases or protein phosphatases.

We speculate that increased concentrations of cGMP, resulting from increases in the activity of NOS and sGC, lead to an increased influx of calcium through phosphorylated membrane channels in response to the second dose of 5HT, resulting in potentiation. There are several studies in *Lymnaea* showing that the effects of 5HT are mediated by cGMP-dependent phosphorylation of calcium channels. Moreover, in *Helix*, modulation of calcium currents in neuron F1 is *via* regulation of a phosphorylation/dephosphorylation cycle of calcium channels (for a summary of data for both *Lymnaea* and *Helix*, see Kits and Mansvelder, 1996). Although we know the seasonal patterns of expression of both NOS and sGC, we have not yet measured changes in the activity of any of the relevant enzymes.

We thank David Champlin, David Chicoine, Robert Pirone and James Walton (University of Southern Maine) for their advice and assistance with the pharmacology experiments, microscopy and graphics. In addition, we thank Leslie Van Eckeris for making the cryostat section and M. Lynn Milstead for drawing Fig. 1 (both from the Whitney Laboratory). Funds were provided to L.F.G. by the Maine Science and Technology Foundation and the Bioscience Research Institute of Southern Maine.

### References

Brady, A. J. B., Warren, J. B., Poole-Wilson, P. A., Williams, T. J. and Harding, S. E. (1993). Nitric oxide attenuates cardiac myocyte contraction. *Am. J. Physiol.* **265**, H176-H182.

Buchwalow, I. B., Podzuweit, T., Bocker, W., Samoilova, V. E., Thomas, S., Wellner, M., Baba, H. A., Robenek, H., Schnekenburger, J. and Lerch, M. M. (2002). Vascular smooth muscle and nitric oxide synthase. *FASEB J.* **16**, 500-508.

Cropper, E. C., Lloyd, P. E., Reed, W., Tenebaum, R., Kupfermann, I. and Weiss, K. R. (1987a). Multiple neuropeptides in cholinergic motor neurons of *Aplysia*: evidence for modulation intrinsic to the motor circuit. *Proc. Natl. Acad. Sci. USA* **84**, 3486-3490.

Cropper, E. C., Tenebaum, R., Kolks, M. A. G., Kupfermann, I. and Weiss, K. R. (1987b). Myomodulin: a bioactive neuropeptide present in an identified cholinergic buccal motor neuron of *Aplysia*. *Proc. Natl. Acad. Sci. USA* **84**, 5483-5486.

Cropper, E. C., Price, D., Tenebaum, R., Kupfermann, I. and Weiss, K. R. (1990). Release of peptide cotransmitters from a cholinergic motor neuron under physiological conditions. *Proc. Natl. Acad. Sci. USA* **87**, 933-937.

Decostre, V., Gillis, J. M. and Gailly, P. (2000). Effect of adrenaline on the post-tetanic potentiation in mouse skeletal muscle. *J. Muscle Res. Cell Motil.* **21**, 247-254.

Denninger, J. W. and Marletta, M. A. (1999). Guanylate cyclase and the NO/cGMP signaling pathway. *Biochem. Biophys. Acta* **1411**, 334-350.

Elphick, M. R. and Melarange, R. (2001). Neural control of muscle relaxation in echinoderms. *J. Exp. Biol.* **204**, 875-885.

Erxleben, C. and Hermann, A. (2001). Nitric oxide augments voltage-activated calcium currents of crustacea (*Idotea baltica*) skeletal muscle. *Neurosci. Lett.* **300**, 133-136.

- Eversole, A. G.** (2001). Reproduction in *Mercenaria mercenaria*. In *Biology of The Hard Clam* (ed. J. N. Kraeuter and M. Castagna), pp. 221-260. Amsterdam, The Netherlands: Elsevier Science.
- Gainer, H.** (1972). Effects of experimentally induced diapause on the electrophysiology and protein synthesis patterns of identified molluscan neurons. *Brain Res.* **39**, 387-402.
- Gainey, L. F., Jr, Vining, K. J., Doble, K. E., Waldo, J. M., Candelario-Martínez, A. and Greenberg, M. J.** (1999a). An endogenous SCP-related peptide modulates ciliary beating in the gills of a venerid clam *Mercenaria mercenaria*. *Biol. Bull.* **197**, 159-173.
- Gainey, L. F., Jr, Pirone, R. T. and Greenberg, M. J.** (1999b). Nitric oxide potentiates gill muscle contraction in *Mercenaria mercenaria*. *Amer. Zool.* **39**, 71A.
- Gainey, L. F., Jr, Walton, J. C. and Greenberg, M. J.** (2003). Branchial musculature of a venerid clam: pharmacology, distribution, and innervation. *Biol. Bull.* **204**, 81-95.
- Greenberg, M. J.** (1960). The responses of the *Venus* heart to catechol amines and high concentrations of 5-hydroxytryptamine. *Brit. J. Pharmacol.* **15**, 365-374.
- Greenberg, M. J., Moroz, L. L., Untch, B., Meleshkevitch, E. A. and Gainey, L. F., Jr** (2000). An analog of the mammalian airway: transmitter interactions regulate the functions of the clam gill. *Soc. Neurosci. Abstr.* **26**, 1166.
- Gunst, S. J., Wu, M.-F. and Smith, D. D.** (1993). Contraction history modulates isotonic shortening velocity in smooth muscle. *Am. J. Physiol.* **265**, C467-C476.
- Hare, J. M. and Stamler, J. S.** (1999). NOS: modulator, not mediator of cardiac performance. *Nature Medicine* **5**, 273-274.
- Jaffrey, S. R., Erdjument-Bromage, H., Ferris, C. D., Tempst, P. and Snyder, S.** (2001). Protein S-nitrosylation: a physiological signal for neuronal nitric oxide. *Nature Cell Biol.* **3**, 193-197.
- Kellogg, J. L.** (1892). A contribution to our knowledge of the morphology of lamellibranchiate molluscs. *Bull. US Fish. Comm.* **10**, 389-436.
- Kits, K. S. and Mansvelder, D.** (1996). Voltage gated calcium channels in molluscs: classification, Ca<sup>2+</sup> dependent inactivation, modulation and functional roles. *Invert. Neurosci.* **2**, 9-34.
- Knaub, R. S. and Eversole, A. G.** (1988). Reproduction of different stocks of *Mercenaria mercenaria*. *J. Shellfish Res.* **7**, 371-376.
- Koh, H. and Jacklet, J. W.** (1999). Nitric oxide stimulates cGMP production and mimics synaptic responses in metacerebral neurons of *Aplysia*. *J. Neurosci.* **19**, 3818-3826.
- Marechal, G. and Gailly, P.** (1999). Effects of nitric oxide on the contraction of skeletal muscle. *Cell. Mol. Life Sci.* **55**, 1088-1120.
- Meiss, R. A.** (1997). Mechanics of smooth muscle contraction. In *Cellular Aspects of Smooth Muscle Function* (ed. C. Y. Kao and M. E. Carsten), pp. 169-208. Cambridge, UK: Cambridge University Press.
- Moroz, L. and Gillette, R.** (1995). From Polyplacophora to Cephalopoda: Comparative analysis of nitric oxide signalling in Mollusca. *Acta Biol. Hungarica* **46**, 169-182.
- Ohba, M. and Kawata, H.** (1999). Biphasic nature of inotropic action of nitric oxide donor NOC7 in guinea-pig ventricular trabeculae. *Jap. J. Physiol.* **49**, 389-394.
- Petroff, M. G. V., Kim, S. H., Pepe, S., Dessy, C., Marban, E., Ballingand, J.-L., Sollott, S. J.** (2001). Endogenous nitric oxide mechanisms mediate the stretch dependence of Ca<sup>2+</sup> release in cardiomyocytes. *Nature Cell Biol.* **3**, 867-873.
- Pilarski, J. Q. and Brechue, W. F.** (2002). Preservation of force generation during repetitive contractions is due to postactivation potentiation (PAP). *FASEB J.* **16**, A770.
- Reading, S. A. and Barclay, J. K.** (2002). The inotropic effect of nitric oxide on mammalian papillary muscle is dependent on the level of beta 1-adrenergic stimulation. *Can. J. Physiol. Pharmacol.* **80**, 569-577.
- Rosenthal, J.** (1969). Post tetanic potentiation at the neuromuscular junction of the frog. *J. Physiol.* **203**, 121-133.
- Satoh, S. and Naoki, M.** (2001). Intracellular mechanisms of cGMP-mediated regulation of myocardial contraction. *Basic Res. Cardiol.* **96**, 652-658.
- Schipp, R. and Gebauer, M.** (1999). Nitric oxide: a vasodilatory mediator in the cephalic aorta of *Sepia officinalis* (L.) (Cephalopoda). *Invert. Neurosci.* **4**, 9-15.
- Stamler, J. S. and Meissner, G.** (2001). Physiology of nitric oxide in skeletal muscle. *Physiol. Rev.* **81**, 209-237.
- Untch, B., Greenberg, M. J. and Moroz, L.** (1999). Nitric oxide producing cells in the CNS and peripheral tissues of *Mercenaria mercenaria* (Bivalvia): A histochemical study. *Amer. Zool.* **39**, 41A.
- Welsh, J. H., Smith, R. I. and Kammer, A. E.** (1968). *Laboratory Exercises in Invertebrate Physiology*. 3rd edition. Minneapolis: Burgess.