

Review

High rates of HCO_3^- secretion and Cl^- absorption against adverse gradients in the marine teleost intestine: the involvement of an electrogenic anion exchanger and H^+ -pump metabolon?

M. Grosell*, E. M. Mager, C. Williams and J. R. Taylor

RSMAS, University of Miami, 4600 Rickenbacker Causeway, Miami, FL 33149, USA

*Author for correspondence (e-mail: mgrosell@rsmas.miami.edu)

Accepted 19 March 2009

Summary

Anion exchange contributes significantly to intestinal Cl^- absorption in marine teleost fish and is thus vital for successful osmoregulation. This anion exchange process leads to high luminal HCO_3^- concentrations (up to $\sim 100 \text{ mmol l}^{-1}$) and high pH and results in the formation of CaCO_3 precipitates in the intestinal lumen. Recent advances in our understanding of the transport processes involved in intestinal anion exchange in marine teleost fish include the demonstration of a role for the H^+ -pump (V-ATPase) in apical H^+ extrusion and the presence of an electrogenic ($\text{nHCO}_3^-/\text{Cl}^-$) exchange protein (SLC26a6). The H^+ -V-ATPase defends against cellular acidification, which might otherwise occur as a consequence of the high rates of base secretion. In addition, apical H^+ extrusion probably maintains lower HCO_3^- concentrations in the unstirred layer at the apical surface than in the bulk luminal fluids and thus facilitates continued anion exchange. Furthermore, H^+ -V-ATPase activity hyperpolarizes the apical membrane potential that provides the driving force for apical electrogenic $\text{nHCO}_3^-/\text{Cl}^-$ exchange, which appears to occur against both Cl^- and HCO_3^- electrochemical gradients. We propose that a similar coupling between apical H^+ extrusion and $\text{nHCO}_3^-/\text{Cl}^-$ exchange accounts for Cl^- uptake in freshwater fish and amphibians against very steep Cl^- gradients.

Key words: osmoregulation, water absorption, seawater, pH-stat titration, fish.

Introduction

Most vertebrates residing in the marine environment maintain extracellular fluid osmotic pressure much below that of the surrounding water and are therefore faced with continuous dehydration (Marshall and Grosell, 2005). In these animals, ingestion of seawater and subsequent intestinal salt and water absorption offsets the osmotic fluid loss to allow for hydromineral homeostasis and is accompanied by compensatory excretion of monovalent ions by the gill and divalent ions by the kidney (Marshall and Grosell, 2005).

Monovalent Na^+ and Cl^- absorption provides the osmotic driving force for water absorption across the intestinal epithelium (Mackay and Janicki, 1978; Skadhauge, 1974; Usher et al., 1991), which is how marine teleosts appears to absorb fluid hyperosmotic to the blood plasma (Grosell, 2006; Grosell and Taylor, 2007; Scott et al., 2008). The present review aims to summarize what is currently known about Na^+ and Cl^- absorption by the marine teleost intestine, which will include a detailed discussion of recent advances in our understanding of Cl^- absorption *via* anion exchange in particular.

Na^+ absorption by the marine teleost intestine

It has long been recognized that intestinal Na^+ absorption is ultimately fueled by Na^+/K^+ -ATPase (referred to as NKA in the following), as is the case for most other absorptive epithelia (Jampol and Epstein, 1970; Colin et al., 1985). The NKA is localized to the basolateral membrane, although the columnar nature of the enterocytes dictates that the majority of the NKA protein resides in the lateral membrane, pumping Na^+ into the lateral interspace (lis) (Fig. 1). The intestinal epithelium exhibits the

highest NKA activity of the three teleost osmoregulatory tissues (gill, kidney and intestine) (Hogstrand et al., 1999; Grosell et al., 1999), an activity that in many cases is higher in seawater-acclimated euryhaline fish than in freshwater-acclimated conspecifics (Fuentes et al., 1997; Colin et al., 1985; Jampol and Epstein, 1970; Kelly et al., 1999; Madsen et al., 1994). The electrogenic nature of NKA contributes to a strong cytosolic negative membrane potential and a low cytosolic Na^+ concentration in the order of 15 mmol l^{-1} (Zuidema et al., 1986). With an apical membrane potential of -100 mV (inside negative) (Loretz, 1995), the cytosolic Na^+ concentration is substantially below equilibrium with luminal Na^+ concentrations ($50\text{--}100 \text{ mmol l}^{-1}$) *in vivo*.

The inward-directed electrochemical Na^+ gradient facilitates Na^+ uptake across the apical membrane, which is generally ascribed to two parallel co-transport systems: the absorptive $\text{Na}^+:\text{K}^+:2\text{Cl}^-$ co-transporter (NKCC2 in the following) and the $\text{Na}^+:\text{Cl}^-$ co-transporter (NC in the following) (Field et al., 1980; Frizzell et al., 1979; Halm et al., 1985; Musch et al., 1982; Cutler and Cramb, 2002). The coupling of Na^+ uptake to the uptake of K^+ and Cl^- is not necessary for Na^+ from a thermodynamical perspective because the electrochemical gradient for Na^+ is inwardly directed. These co-transporters therefore appear to allow for Cl^- uptake against an electrochemical gradient by electroneutral coupling to Na^+ uptake (see discussion of Cl^- uptake below). Regardless of these thermodynamical considerations, NKCC2 and NC clearly confer Na^+ uptake but it should be recognized that Na^+ entry across the apical membrane could occur *via* Na^+ channels (which have yet to be demonstrated) or *via* Na^+/H^+ exchange (NHE) mechanisms. There is some evidence that apical NHE isoforms are present in the

intestinal epithelium of marine fish and that such transporters may play a role in seawater osmoregulation. Recent findings of elevated mRNA levels of the apical NHE3 isoform in rainbow trout

following transfer from freshwater to 65% seawater suggest a role for NHE3 in the intestinal salt absorption required for marine osmoregulation (Grosell et al., 2007). So far, this molecular evidence stands alone and functional evidence is lacking for the involvement of apical isoforms like NHE3, NHE8 and NHE2 (Xu et al., 2008; Zachos et al., 2005) in intestinal Na^+ absorption by marine teleosts. However, considering that both H^+ and Na^+ gradients across the apical membrane in the marine teleost intestine favor Na^+/H^+ exchange and also considering the importance of these NHE isoforms in mammalian intestinal salt absorption (Xu et al., 2008; Zachos et al., 2005), it seems likely that marine fish also utilize this mechanism.

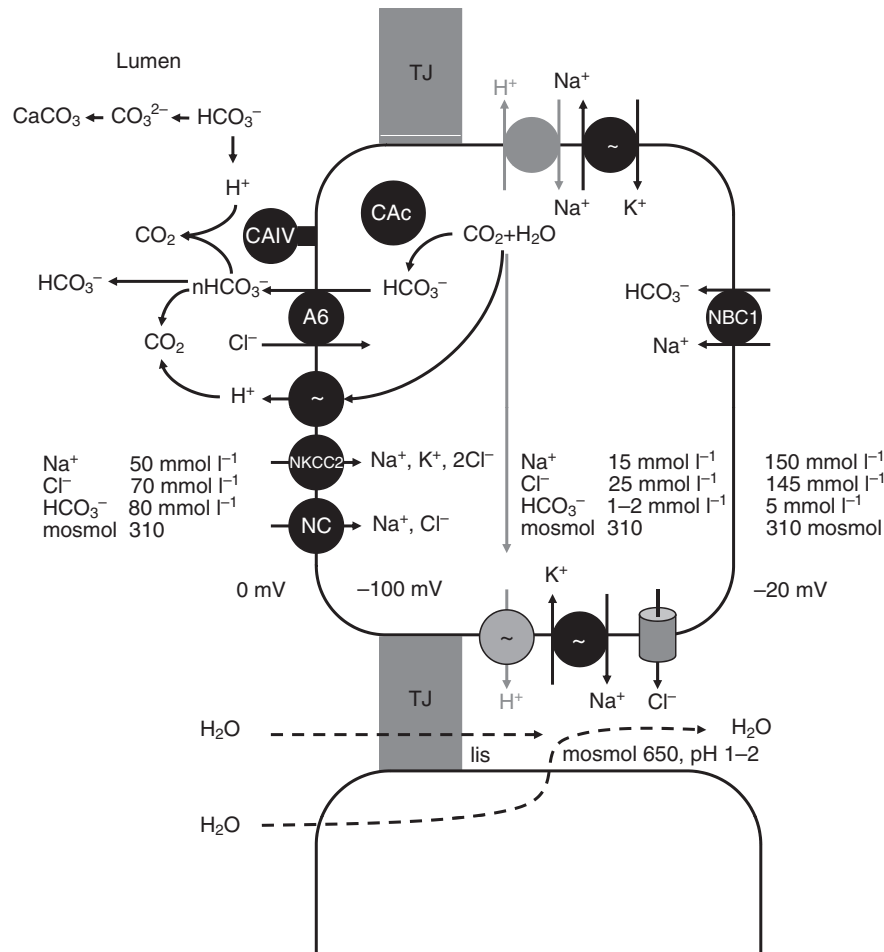

Fig. 1. Schematic presentation of accepted and putative transport processes in the intestinal epithelium of marine teleost fish. Transcellular or/and paracellular water transport (broken lines) is driven by active NaCl absorption, providing a hyperosmotic coupling compartment in the lateral interspace (lis). Apical Na^+ entry via NKCC2 and NC co-transporters and extrusion across the basolateral membrane via Na^+/K^+ -ATPase accounts for transepithelial Na^+ movement. Apical entry of Cl^- occurs via both co-transporters and $\text{Cl}^-/\text{HCO}_3^-$ exchange conducted at least in part by the SLC26a6 anion exchanger whereas basolateral Cl^- channels allow for movement of Cl^- from the cell across the basolateral membrane. Cellular substrate (HCO_3^-) for apical anion exchange is provided in part by HCO_3^- entry across the apical membrane via NBC1 and in part by hydration of endogenous CO_2 . Cytosolic carbonic anhydrase (CAc) found mainly in the apical region of the enterocytes facilitates the CO_2 hydration reaction. Protons arising from the hydration of CO_2 are extruded mainly across the basolateral membrane by a Na^+ -dependent pathway and possibly by vacuolar H^+ pumps. Recent findings revealed that some H^+ extrusion occurs across the apical membrane via H^+ -pumps and that this H^+ secretion masks some of the apical HCO_3^- secretion by dehydration yielding molecular CO_2 . This molecular CO_2 may diffuse back into the enterocytes for re-hydration and continued apical anion exchange. Luminal conversion of HCO_3^- to CO_2 is facilitated by membrane-bound carbonic anhydrase (CAIV) and possibly other isoforms, a process that consumes H^+ and thereby contributes to luminal alkalization and CO_3^{2-} formation. The titration of luminal HCO_3^- and formation of CO_3^{2-} , which facilitates formation of CaCO_3 precipitates both act to reduce luminal osmotic pressure and thus aid water absorption. The electrogenic anion exchanger SLC26a6 exports nHCO_3^- in exchange for 1Cl^- and its activity is therefore enhanced by the hyperpolarizing effect of the H^+ -pump. The constellation of an apical electrogenic $\text{nHCO}_3^-/\text{Cl}^-$ exchanger and electrogenic H^+ -pump constitutes a transport metabolon perhaps accounting for the apparently active secretion of HCO_3^- and the uphill movement of Cl^- across the apical membrane. Note that the value for osmotic pressure and pH in the absorbed fluids are based on measured net movements of H_2O and electrolytes, including H^+ s but that the degree of hypertonicity and acidity in lis is probably much less than indicated due to rapid equilibration with sub-epithelial fluid compartments. See text for further details. NKCC2, $\text{Na}^+:\text{K}^+:2\text{Cl}^-$ co-transporter; NC, $\text{Na}^+:\text{Cl}^-$ co-transporter; NBC, $\text{Na}^+:\text{HCO}_3^-$ co-transporter; TJ, tight junction.

Cl^- absorption by the marine teleost intestine

As with Na^+ , transepithelial Cl^- absorption under *in vivo*-like conditions occurs against electrochemical gradients. However, in contrast to Na^+ , for which apical entry occurs downhill electrochemical gradients and the basolateral extrusion is uphill, the opposite is true for Cl^- . Cytosolic Cl^- is above thermodynamical equilibrium with extracellular fluids and basolateral Cl^- channels allowing Cl^- diffusion from the cell to the extracellular fluids (Loretz and Fournier, 1988). Entry of Cl^- across the apical membrane is uphill from an electrochemical perspective. Notably, a seawater-acclimated killifish Cl^- channel, the cystic fibrosis transmembrane regulator (CFTR), which resides primarily in the basolateral membrane of the enterocytes, can be activated in the apical membrane by intracellular Ca^{2+} and cyclic AMP to perform intestinal Cl^- secretion (Marshall et al., 2002). However, the normal physiological state of Cl^- and water absorption is associated with basolateral, not apical, CFTR activity.

The co-transporters discussed above, NC and NKCC2, facilitate the uphill movement of Cl^- from the lumen across the apical membrane fueled by the electrochemical Na^+ gradient established by NKA.

Intestinal Cl^- absorption via anion exchange

The past decade has revealed that the high intestinal fluid pH and HCO_3^- concentrations, first reported in 1930 (Smith, 1930), are the product of apical $\text{Cl}^-/\text{HCO}_3^-$ exchange by the intestinal epithelium and that this process is part of successful osmoregulation in seawater fish (Wilson et al., 2002; Wilson, 1999; Grosell et al., 2001; Grosell et al., 2005; Grosell, 2006; Grosell and Genz, 2006; Taylor and Grosell, 2006).

As such, it appears common to all marine vertebrates relying on seawater ingestion that they have high intestinal fluid pH and HCO_3^-

concentrations, arising from high rates of HCO_3^- secretion by the intestinal epithelium (Grosell et al., 2001; Taylor and Grosell, 2006; Wilson, 1999; Smith, 1930). Evidence for apical anion exchange, which can account for more than 50% of the total Cl^- absorption by the intestinal epithelium, includes dependence of HCO_3^- secretion on luminal Cl^- (Dixon and Loretz, 1986; Ando and Subramanyam, 1990; Wilson et al., 1996; Grosell et al., 2001; Grosell et al., 2005) and DIDS (4,4'-diisothiocyanatostilbene-2,2'-disulphonic acid) sensitivity of both Cl^- absorption and HCO_3^- secretion in several marine teleost species (Ando and Subramanyam, 1990; Grosell and Jensen, 1999; Grosell et al., 2001).

While anion exchange, when electroneutral, eliminates the constraint on apical Cl^- uptake imposed by the substantial inside negative apical membrane potential, the accompanying HCO_3^- secretion occurs against very high HCO_3^- gradients resulting from the luminal HCO_3^- concentrations, in some cases reaching 100mmol l^{-1} (McDonald and Grosell, 2006; Wilson, 1999; Grosell, 2007).

Assuming electroneutral anion apical exchange, we have previously estimated the cytosolic HCO_3^- concentration necessary for anion exchange to occur to be around 10mmol l^{-1} , considering measured luminal Cl^- and HCO_3^- concentrations and realistic cytosolic Cl^- concentrations (Grosell et al., 2001; Grosell, 2006). This concentration is much higher than the cytosolic HCO_3^- concentration (1.5mmol l^{-1}) that one would predict from intracellular pH, assuming no CO_2 diffusion limitation in the intestinal tissue (Grosell et al., 2001) and may therefore seem unrealistic. However, diffusion limitations as seen in trout muscle (Wang et al., 1998) may contribute to higher cytosolic HCO_3^- and the possibility of subcellular microenvironments of high carbonic anhydrase (CA) activity near the apical membrane has also been proposed (Grosell, 2006). The latter suggestion was motivated by reports of direct interactions between CAII and several members of the SLC4 family of HCO_3^- transport proteins and at least one member of the SLC26 family of anion exchangers (McMurtrie et al., 2004; Sterling et al., 2002; Sterling et al., 2001; Becker and Deitmer, 2007). A direct functional interaction between SLC4 bicarbonate transporters and CAII has since been challenged by observations from co-expression experiments but co-compartmentalization *in situ* for CA and SLC26 members cannot be excluded (Lu et al., 2006; Piermarini et al., 2007). Indeed, observations of intense immunoreactivity of the intestinal apical region of rainbow trout acclimated to 65% seawater with a monoclonal antibody for cytosolic CA (CAc) (Grosell et al., 2007) demonstrate such compartmentalization.

Nature of the anion exchange protein(s)

Until very recently, little was known about the nature of the marine teleost intestinal anion exchange protein(s). Of at least 14 different transporters capable of Na^+ -independent anion exchange in the gene families SLC4 (Alper 2006; Romero et al., 2004) and SLC26 (Mount and Romero, 2004), many have been identified in fish (Shmukler et al., 2005; Musch and Goldstein, 2005; Guizouarn et al., 2005; Renfro and Pritchard, 1983; Pelis and Renfro, 2003; Piermarini et al., 2002). The SLC26 gene family contains at least two (of >10) candidate genes likely to be involved in intestinal anion exchange: A3 and A6 (also known as DRA, downregulated in adema and PAT1, putative anion transporter 1), which, in mammals, are abundant in the apical membrane of the intestinal mucosa (Mount and Romero, 2004). Of these two, SLC26a3, which is a Cl^- /base exchanger (Melvin et al., 1999; Ko et al., 2002; Alper

et al., 2001) is already ascribed a role in mammalian intestinal salt absorption (Höglund et al., 1996). The other likely candidate from this gene family, SLC26a6, is also abundantly expressed in the mammalian intestine (Waldegger et al., 2001; Xie et al., 2002; Lohi et al., 2000) and appears to be involved in apical Cl^- entry in the proximal tubule (Xie et al., 2002; Knauf et al., 2001; Jiang et al., 2002). A possible unique feature of SLC26a3 and SLC26a6 anion exchangers is that they may be electrogenic, although this is subject to controversy and appears to differ among species (Chernova et al., 2005; Clark et al., 2008). As discussed below, electrogenicity is likely to be significant for apical anion exchange in marine teleost fish. Likely alternative genes from the SLC26 family include SLC26a2 and SLC26a4 (pendrin) and a possible candidate from the SLC4 family is SLC4a3 of which all are expressed apically in mammalian HCO_3^- secreting epithelia (Alper, 2006; Mount and Romero, 2004). In addition, SLC4a2, which is preferentially expressed in the basolateral region of the mammalian kidney, was recently shown to have largely apical localization in the zebrafish pronephric duct epithelium and to be stimulated by hypertonicity (Shmukler et al., 2005). Due to the apical localization of teleost SLC4a2 and the stimulation by hypertonicity, this SLC4 transporter can also be considered a likely candidate contributing to intestinal anion exchange in the marine teleost intestine.

Electrogenicity of both SLC26a3 ($\text{HCO}_3^-/\text{nCl}^-$) and SLC26a6 ($\text{nHCO}_3^-/\text{Cl}^-$) has been reported although it appears to differ among species (Mount and Romero, 2004; Chernova et al., 2005; Clark et al., 2008). Considering the electrochemical gradients for Cl^- and HCO_3^- (discussed above), the potential net export of negative charge conducted by SLC26a6 makes this a very likely candidate for the apparent active uptake of Cl^- and secretion of HCO_3^- as the exchange process would be powered by the apical membrane potential (-100mV inside negative). In agreement with this analysis, a recent and very elegant paper identified a pufferfish SLC26a6 and a SLC4 family member $\text{Na}^+:\text{HCO}_3^-$ co-transporter (NBC1) as likely candidates for proteins involved in intestinal base secretion in marine fish (Kurita et al., 2008). A genome screening approach based on the complete genome sequence for the tiger puffer (*Takifugu rubripes*) was employed to identify candidate membrane proteins capable of HCO_3^- transport from the intestine of the closely related euryhaline mefugu (*Takifugu obscurus*). Of the identified clones, intestinal mRNA expression of an SLC26a6A isoform and a NBC1 of the SLC4 family were found to increase in response to seawater exposure (Kurita et al., 2008). Furthermore, the mefugu SLC26a6 (mfSLC26a6) was found to conduct base secretion and to be electrogenic (consistent with $\text{nHCO}_3^-/\text{Cl}^-$ exchange) when expressed in *Xenopus* oocytes (Kurita et al., 2008).

Source of HCO_3^- for apical anion exchange

Both transepithelial HCO_3^- transport and hydration of endogenous CO_2 contribute to apical HCO_3^- secretion by marine fish intestinal epithelia in most species examined so far (Dixon and Loretz, 1986; Ando and Subramanyam, 1990; Grosell et al., 2005; Grosell and Genz, 2006). By contrast, recent studies of rainbow trout anterior intestinal epithelia revealed that endogenous CO_2 alone is sufficient to sustain resting levels of intestinal HCO_3^- secretion (Grosell et al., 2009). Basolateral, Na^+ -dependent HCO_3^- entry as part of transepithelial HCO_3^- secretion was first reported for the Japanese eel (Ando and Subramanyam, 1990) and has since been proposed to also contribute to base secretion in the toadfish intestine (Grosell and Genz, 2006). In support of this, a recent study on the euryhaline mefugu identified NBC1 in the intestinal epithelium, showing elevated mRNA expression in seawater compared with freshwater

basolateral protein localization and electrogenic HCO_3^- transport (Kurita et al., 2008). Furthermore, a recently cloned toadfish NBC1, when expressed in oocytes, exhibits HCO_3^- transport kinetics similar to the intestinal tissue in which basolateral NBC1 is rate limiting (J.R.T., E.M.M. and M.G., submitted). In toadfish, as in mefugu, elevated ambient salinity results in increased NBC1 mRNA expression strongly supporting a role in the elevated intestinal HCO_3^- secretion observed at higher salinities (Genz et al., 2008; Kurita et al., 2008).

Involvement of CA in intestinal HCO_3^- secretion

Hydration of endogenous CO_2 to provide cellular substrate for intestinal HCO_3^- secretion appears to be facilitated by CA (Dixon and Loretz, 1986; Wilson et al., 1996; Grosell et al., 2007; Grosell et al., 2009). The effects of permeant pharmacological agents combined with observations of elevated mRNA expression of the CAc and overall increased cytosolic enzymatic activity in rainbow trout following transfer to elevated salinity (Grosell et al., 2007) provide strong evidence for the involvement of CAc in catalyzing the CO_2 hydration reaction. In addition, an extracellular, membrane-bound CA isoform seems to be involved in intestinal base secretion in seawater-acclimated rainbow trout. Observations of reduced intestinal HCO_3^- secretion in the presence of F3500, an impermeant CA inhibitor, elevated mRNA expression of the membrane-bound CAIV and elevated membrane-associated enzymatic CA activity document a role for CAIV and possibly other membrane-associated extracellular CAs in intestinal HCO_3^- secretion (Fig. 1).

H^+ extrusion from marine teleost enterocytes

Because hydration of endogenous CO_2 is an important source of HCO_3^- for secretion across the apical membrane, the H^+ resulting from this hydration reaction must be secreted from the intestinal epithelial cells to prevent cellular acidification. Furthermore, because the intestinal epithelium exhibits net base secretion, part of this H^+ secretion must be across the basolateral membrane. The whole animal implication of this net acid gain from intestinal transport processes associated with hydromineral balance is a potential for systemic acidosis during exposure to elevated salinity. Measurements of H^+ secretion across the basolateral membrane and intestinal water absorption in toadfish have revealed that the gain of water and H^+ translates to a theoretical pH in the absorbed fluids of <2 (Grosell and Genz, 2006; Grosell and Taylor, 2007). However, it should be recognized that this absorption of strong acid does not mean that the pH in the lateral interspace is as acidic as would be predicted simply from dividing the acid flux with the corresponding water absorption rate. High diffusion rates of H^+ from the lateral interspace to the extracellular fluid underlying the epithelium will act to reduce the H^+ concentration in the lateral interspace. Nevertheless, the lateral interspace fluid compartment can be expected to be acidic compared with the bulk extracellular fluids, although the extent of this acidity is unknown.

The systemic acid gain associated with HCO_3^- secretion, drinking rate and intestinal water absorption probably explain the transient acidosis often observed upon transfer of euryhaline fish from freshwater to seawater (Nonnotte and Truchot, 1990; Wilkes and McMahon, 1986; Maxime et al., 1991). The fact that this acid-base disturbance is transient despite a continued demand for fluid replacement, drinking and thus HCO_3^- secretion after transfer to seawater indicates that a compensatory response is evoked during acclimation to elevated salinity. A recent study on toadfish acclimated to iso-osmotic salinity, seawater and 50 p.p.t. salinity

revealed increased intestinal HCO_3^- secretion and increased rectal HCO_3^- excretion with increasing ambient salinity (Genz et al., 2008). In toadfish, transepithelial HCO_3^- transport and endogenous CO_2 hydration contribute equally to luminal alkalization (Grosell and Genz, 2006) and both these components add to a systemic net acid gain at elevated ambient salinity (Grosell and Genz, 2006; Grosell and Taylor, 2007). Acid-base balance is maintained in toadfish at different salinities despite these differences in systemic acid gain due to a compensatory acid secretion, presumably by the gills (Genz et al., 2008). The transient nature of the acidosis induced by transfer of euryhaline fish from freshwater to seawater (see above) probably reflects first the onset of drinking and thus intestinal base secretion and second, with a delay, the evoked compensatory branchial acid extrusion (Genz et al., 2008).

The nature of the transport proteins involved in acid extrusion across the basolateral membrane is unknown, although evidence from toadfish indicates that H^+ extrusion is dependent on Na^+ in the serosal fluids, suggesting a Na^+/H^+ exchange mechanism (Grosell and Genz, 2006). Evidence from rainbow trout suggests both basolateral and apical localization of the vacuolar H^+ -pump, which shows robust mRNA and enzymatic activity increases following transfer from freshwater to hyperosmotic salinities (Grosell et al., 2007). However, so far no functional evidence exists for the involvement of a basolateral H^+ V-ATPase (referred to as H^+ -pump in the following) in the intestinal epithelium of any marine teleost and the evidence for Na^+/H^+ exchange is restricted to toadfish. Thus, whether these differences between toadfish and rainbow trout (and probably other species) indicate species differences or multiple parallel H^+ extrusion pathways in the basolateral membrane of marine teleost intestinal epithelia offers a fruitful area for further study.

Considering that the marine teleost intestinal epithelium exhibits net base secretion, recent findings of intense immuno cross-reactivity between a H^+ -pump antibody and the apical region of seawater-acclimated rainbow trout was surprising (Grosell et al., 2007). Furthermore, the above mentioned increase in mRNA and corresponding increase in H^+ -pump enzymatic activity during seawater acclimation suggested a role for an intestinal apical H^+ -pump, a basolateral H^+ -pump or both in marine teleost osmoregulation. A follow up study demonstrated the functional significance of an apical H^+ -pump in the anterior intestine of seawater-acclimated rainbow trout, indicating that apical anion exchange operates in concert with an apical proton pump (Grosell et al., 2009). This conclusion was based on observations of an apparent increase in net base secretion following the addition of $1\ \mu\text{mol l}^{-1}$ bafilomycin, a H^+ -pump inhibitor, to the luminal saline.

A H^+ -pump, SLC26a6 'metabolon'?

The presence of a functional apical H^+ -pump in the marine teleost intestine for which a role of net base secretion in salt and water absorption has been firmly established may at first seem paradoxical. However, considering the role of apical anion exchange in Cl^- absorption and the need for water absorption in the absence of net osmotic gradients, the adaptive significance of simultaneous HCO_3^- and H^+ secretion can be envisioned. First, the titration of luminal HCO_3^- near the apical surface of the epithelium will reduce the net HCO_3^- gradients across the apical membrane, which would favor continued $\text{Cl}^-/\text{HCO}_3^-$ exchange. Second, apical rather than basolateral H^+ extrusion would defend cytosolic pH near the apical region where a high abundance of CAc catalyzes CO_2 hydration to form H^+ and HCO_3^- for anion exchange and would

prevent reversal of the hydration reaction. Third and of direct importance for water absorption is the osmotic effect of absorbing Cl^- in exchange for HCO_3^- and H^+ , which would form osmotically inert molecular CO_2 and thus reduce luminal osmotic pressure acting to enhance water absorption. The potential exists for this molecular CO_2 to diffuse back into the cell for rehydration by CAC to again form substrate for apical anion exchange and would certainly be adaptive.

In addition to the above factors an apical H^+ -pump, which is electrogenic, would act to (hyper)polarize the apical membrane. Assuming that teleost SLC26a6 proteins are electrogenic (their activity affects, and is influenced by, membrane potential), operating in $\text{nHCO}_3^-/\text{Cl}^-$ mode, as is the case for the mefugu protein, hyperpolarization of the apical membrane by the H^+ -pump would enhance the overall electrochemical potential for SLC26a6 anion exchange. The latter suggestion assumes the presence of both the H^+ -pump and an electrogenic SLC26a6 in the apical region of the intestinal epithelium. While an apical proton pump has been demonstrated in seawater-acclimated trout intestinal epithelium and an electrogenic SLC26a6 has been documented in the mefugu intestinal epithelium, the presence of the two components of the proposed metabolon ('metabolon' is a functional unit not necessarily implying physical association) have yet to be demonstrated in the same intestinal epithelium.

As part of this review we therefore present original data confirming that the toadfish SLC26a6 (tfSLC26a6), which is abundantly expressed in the intestinal tissue, is an electrogenic protein that conducts Cl^- absorption. Furthermore, we demonstrate the presence of a functional H^+ -pump in the apical membrane of the toadfish intestinal epithelium, as previously observed in rainbow trout (see below). The concurrence of these two apical transporters supports the idea of a H^+ -pump, SLC26a6 metabolon accounting for the electrochemical uphill movement of Cl^- into the enterocyte *via* anion exchange.

Materials and methods

Cloning of the tfSLC26a6

RNA extractions

Following deep sedation with MS-222 and euthanization, tissues were harvested, quickly placed into cryotubes and snap-frozen in liquid nitrogen. Total RNA was subsequently isolated using RNA

STAT-60 solution (Tel-Test, Friendsworth, TX, USA) and a Polytron homogenizer. To remove any traces of genomic DNA, 10 μg from each isolate was treated with DNase I (Turbo DNA-free kit; Applied Biosystems, Foster City, CA, USA/Ambion, Austin, TX, USA) followed by gel electrophoresis to confirm that the integrity of RNA was maintained.

5' and 3' rapid amplification of cDNA ends (RACE)

To obtain toadfish sequence for RACE primer design, an initial fragment (544 bp) of SLC26a6 was obtained by PCR of toadfish intestine cDNA using primers derived from conserved regions across three eel SLC26a6 sequences (provided by Dr Jonathan Wilson) (Table 1). Reactions were performed with AmpliTaq Gold polymerase (Applied Biosystems) using the following cycling parameters: 95°C for 30 s, 55°C for 30 s and 72°C for 1 min.

Total RNA from toadfish intestine was further purified using the MicroPoly(A) Purist kit (Applied Biosystems/Ambion) to acquire poly(A) RNA as a template for RACE reactions. The BD SMART RACE cDNA Amplification Kit (BD Biosciences, Rockville, MD, USA) was used to reverse transcribe 1 μg poly(A) RNA and amplify RACE-ready cDNA. Primers for RACE reactions were designed from a toadfish-specific sequence (i.e. sequence between the flanking regions corresponding to the eel primers used in the initial PCR described above) (Table 1). Touchdown PCR cycling conditions were as follows: five cycles of 94°C for 30 s, 68°C for 30 s and 72°C for 4-min followed by five and 25 cycles as previously except with annealing temperatures of 66°C and 64°C, respectively. A second round of amplification was carried out on diluted aliquots (1:100) of the initial amplifications using nested primers (Table 1) by repeating the final 20 PCR cycles as described above. Products were gel-purified, TA-cloned into the pCR 2.1 vector (Invitrogen, Carlsbad, CA, USA) and sequenced.

cDNA synthesis and primer design for quantitative PCR

For quantitative PCR (qPCR), cDNA was synthesized from 1 μg DNase I-treated total RNA using the SuperScript II First-Strand System with random hexamers as per the manufacturer's instructions (Invitrogen, Carlsbad, CA, USA). Following RNase H treatment, reactions were diluted tenfold in Tris-EDTA (TE) buffer. Because toadfish-specific sequence was unavailable for the 'housekeeping' genes, primers for normalization were designed

Table 1. Primers used for qPCR and cloning of toadfish SLC26a6

Primer	Sequence (5'→3')	Product size (bp)
Eel SLC26a6-F*	TGGTGCGGTTTGGATTTGTG	544
Eel SLC26a6-R*	ACCAGTTCCTGGTTGCTGTC	
SLC26a6-5' RACE	GAAATGTTGATGGCGTAGCCACG	1124†
SLC26a6-n5' RACE	GCCACAGCAAACGCATCACCTATCAC	1096†
SLC26a6-3' RACE	GCCTGTCGCTCCAGACGCAAGTATG	3245†
SLC26a6-n3' RACE	GTGATAGGTGATGCGTTTTGCTGTGGC	3211†
ORF SLC26a6-F	ATGGAGGAGAGGGACGGTTC	2473
ORF SLC26a6-R	TCACATCTGGGTGGTGCAGG	
qPCR SLC26a6-F	CTCTCACTTATTTATACTGTGGTG	140
qPCR SLC26a6-R	GCAGGTTATGTCTGTAACATGC	
EF1 α -F	AGGTCATCATCCTGAACCAC	143
EF1 α -R	GTTGTCCTCAAGCTTCTTGC	
18S-F	GCTCGTAGTTGGATCTCGG	166
18S-R	GGCTGCTTTGAACACTC	

*Primer sequences used for initial cloning of toadfish SLC26a6 fragment, generously provided by Dr Jonathan Wilson, were designed from conserved regions of three eel SLC26a6 aligned sequences.

†Sizes include 45 bp at 5' end corresponding to Clontech Universal Primer A sequence. Abbreviations: forward primer (F); reverse primer (R); nested primer (n); open reading frame (ORF).

from strongly conserved nucleotide regions across multiple teleost species (≥ 4). All primers for qPCR were designed from the coding regions of each target gene (Table 1).

qPCR

qPCR reactions were performed using the MX4000 thermocycler (Stratagene, La Jolla, CA, USA) with AmpliTaq Gold polymerase (Applied Biosystems) and SYBR Green I (Sigma Chemical Co., St Louis, MO, USA) as the fluorescent reporter dye. All reactions were optimized to establish amplification efficiencies of $>95\%$ using a standard curve derived from at least five serially diluted (tenfold) cDNA samples run in triplicate. Products were initially confirmed by sequencing and all further reactions were verified by observing the specific corresponding melting peak following amplification. Cycling was as follows: 95°C for 5 min followed by 20–40 cycles at 95°C for 30 s, 55°C for 30 s and 72°C for 30 s. Eight biological replicates were used for each tissue. Expression levels were calculated from log-transformed cycle threshold (C_T) values normalized to EF1 α (tissue distribution) or to the mean of EF1 α and 18S (salinity transfer) using a modification of the delta-delta- C_T method (Livak and Schmittgen, 2001) previously described (Vandesompele et al., 2002). Fold change values were expressed relative to the sample with the lowest level of expression.

Tissue distribution of SLC26a6 and hypersalinity-induced SLC26a6 expression changes?

Initially, a total of eight fish were anesthetized and euthanized with MS-222, and gill, liver, spleen, muscle, brain, kidney, esophagus, stomach, anterior intestine, mid intestine, posterior intestine and rectum were obtained by dissection and immediately placed in liquid nitrogen prior to transfer to a -80°C freezer.

From a batch of 40 toadfish (20–30 g) held in flow-through seawater, eight were sampled immediately for gill, anterior, mid, posterior intestine and rectum by dissection while the remaining 32 fish were placed in a 75 l aquarium containing natural Bear Cut, Florida seawater with the salinity raised to 60 p.p.t. by the addition of Instant Ocean (Spectrum Brands, Atlanta, GA, USA). Quality of the 60 p.p.t. water was maintained by biofilter recirculation and fish were maintained at 25°C . At 6, 12, 24 and 96 h post-transfer to 60 p.p.t., a total of eight fish per time point were sampled as above. Obtained tissue samples were flash frozen in liquid nitrogen, stored at -80°C prior to processing as above for RNA extraction, RT and qPCR.

Oocyte expression studies – subcloning of SLC26a6 open reading frame into pGH19 vector

Primers were designed to amplify the complete open reading frame (ORF) of tSLC26a6 (Table 1). PCR was carried out using a high fidelity enzyme mix (BD Advantage 2 polymerase, BD Biosciences) and 5' RACE-ready cDNA as a template with the following touchdown cycling parameters: five cycles of 94°C for 30 s, 67°C for 30 s and 72°C for 4.5 min followed by five and 25 cycles as previously except at 65°C and 63°C annealing temperatures, respectively. Following amplification, the PCR product was gel purified, TA-cloned and sequence verified. The full-length ORF was then subcloned into the EcoRI site of the pGH19 vector (kind gift from Dr Gerhard Dahl, University of Miami, Miller School of Medicine, Miami, FL, USA), using the LigaFast Rapid DNA Ligation System (Promega, Madison, WI, USA). Two microliters of the ligation reaction were used to

transform JM109 competent cells (Promega). Colonies were screened by restriction mapping to identify a plasmid with proper ORF orientation, which was subsequently confirmed by sequencing.

In vitro mRNA transcription for oocyte injection

Templates for transcription were prepared by linearizing recombinant plasmid with *Xho*I followed by proteinase K treatment and subsequent phenol/chloroform extraction and ethanol precipitation. *In vitro*-transcribed mRNA was generated using the mMESSENGER MACHINES T7 kit as per the manufacturer's instructions (Applied Biosystems/Ambion). Briefly, the reaction was assembled using 1 μg linearized plasmid and incubated at 37°C for 2 h followed by 15 min of DNase treatment and recovery of mRNA *via* LiCl precipitation. Samples were resuspended to $\sim 1 \mu\text{g} \mu\text{l}^{-1}$ concentration in nuclease-free water.

Oocyte injections, transport and membrane potential studies

Individual oocytes were injected with 50 nl of the above *in vitro*-transcribed mRNA solution or water using a World Precision Instruments Nanoliter 2000 microinjector-controlled *via* a micromanipulator (Sarasota, FL, USA) and were maintained in ND-96 medium (96 mmol l $^{-1}$ NaCl, 2 mmol l $^{-1}$ KCl, 1.8 mmol l $^{-1}$ CaCl $_2$, 2 mmol l $^{-1}$ MgCl $_2$, 5 mmol l $^{-1}$ Hepes adjusted to pH 7.4 with NaOH) containing 10 i.u. l $^{-1}$ penicillin and 10 μg streptomycin l $^{-1}$ in a 16°C incubator. 48–72 h post-RNA injection, oocytes were subjected to ^{36}Cl uptake measurements following the methods developed by Alper and co-workers (Humphreys et al., 1994). In brief, 6–8 individual oocytes were placed in a single well of a 96-well microplate containing 150 μl ND-96 medium (without antibiotics) and 1.5 μCi ^{36}Cl (as NaCl, Amersham Pharmacia, Pittsburgh, PA, USA, specific activity: 16 $\mu\text{Ci} \text{mg}^{-1}$ Cl $^{-}$) for 30–40 min (exact time recorded). The ND-96 solution used during flux measurements contained 10 $\mu\text{mol} \text{l}^{-1}$ bumetanide to silence endogenous oocyte NKCC activity. Following isotope incubation, individual oocytes were washed by three subsequent transfers to non-radioactive ND-96 medium (5 ml) and placed in individual scintillation counting vials containing 0.5 ml 10% SDS solution. Oocytes were left to dissolve overnight after which 10 ml of scintillation fluid (ICN, Ecolume, Irvine, CA, USA) was added to each vial prior to counting for ^{36}Cl radioactivity.

Membrane potential for water and SLC26a6-injected oocytes were determined 48 h post-injection as described previously (Wang et al., 2007). In brief, microelectrodes were pulled with a vertical puller (David Kopf Instruments, Tujunga, CA, USA) and filled with 3 mol KCl. Electrodes were connected to a voltage clamp circuit (Geneclamp 500B; Axon Instruments, Sunnyvale, CA, USA) and results were captured with a chart recorder (Soltec, San Fernando, CA, USA). Individual oocytes were placed in a recording chamber continuously perfused with saline and impaled with microelectrodes. Saline perfusion was terminated during measurements (Wang et al., 2007).

Measurements of intestinal base secretion *via* Ussing chamber/pH-stat titration

In pursuit of pharmacological evidence for apical H $^{+}$ -pump activity, anterior intestinal segments were mounted in Ussing style chambers (P2400, Physiologic Instruments, San Diego, CA, USA) using tissue holders exposing 0.71 cm 2 (P2413, Physiologic Instruments) and maintained at 25°C throughout experimentation. Tissues were exposed to physiological conditions of *in vitro*-like luminal saline and serosal saline containing physiological levels of

HCO₃⁻ and gassed with 0.3% CO₂ as detailed previously (Grosell and Genz, 2006). Stable rates of base secretion and electrophysiological parameters, recorded as described previously (Grosell and Genz, 2006), were observed for a minimum of 60 min prior to luminal addition of a final concentration of 1 μmol l⁻¹ bafilomycin (LC laboratories, Woburn, MA, USA) in 0.1% DMSO. Base secretion and electrophysiological parameters were recorded for 60 min post bafilomycin addition.

Immunohistochemistry

Anterior intestinal tissue was cut to approximately 2 mm-thick sections and fixed for 4 h at 4°C in five volumes 4% paraformaldehyde (PFA) in 0.1 mol phosphate buffered saline (PBS), which was replaced by ice cold 15% (w/v) sucrose and incubated 2–4 h at 4°C and then replaced by 30% (w/v) sucrose for storage at 4°C. Fixed tissues were sectioned to 10 μm using a cryostat (Leica CM1850, Bannockburn, IL, USA) at -20°C and mounted on pre-cleaned glass microscope slides. Slides were heated on a warming block at 42°C for 15–20 min, and sections were circled with a hydrophobic mini pap pen to create a barrier and conserve reagents. Slides were washed in 1% Tween 20 in 0.1 mol PBS (TPBS) three times, with 5 min for each wash. Primary H⁺ pump antibody [a kind gift from Jonathan Wilson (Wilson et al., 2000)] 1:500 in TPBS or TPBS alone (control) were added to the sections, which were incubated in the dark overnight at 4°C. The TPBS solutions were aspirated from the sections and slides

were washed in TPBS as described above. A secondary antibody cocktail was then applied to all sections, containing Alexa Fluor 488-conjugated anti-rabbit IgG (1:300 dilution; Invitrogen) in TPBS, for a 1 h dark incubation at room temperature. Following aspiration of secondary antibody cocktails and additional washes with TPBS as described above, sections were mounted with Vectashield mounting medium for fluorescence with DAPI (Vector Laboratories, Burlingame, CA, USA). Fluorescence was detected via an Olympus BX61 fluorescent microscope with micropublisher 3 MP color CCD camera and Q-capture imaging system (QImaging, Surrey, BC, Canada) and processed using IPLab imaging software (BD Biosciences).

Data presentation and statistical evaluation

All data are presented as means ± s.e.m. Salinity-induced tfSLC26a6 mRNA expression changes were compared with the appropriate pre-transfer expression level by Student's *t*-tests. ³⁶Cl-uptake and membrane potential for tfSLC26a6 mRNA-injected and H₂O-injected oocytes were compared using Student's *t*-tests. Statistical evaluation of the effects of bafilomycin on intestinal HCO₃⁻ secretion and electrophysiological parameters was performed by comparing the data from 10 min intervals following bafilomycin addition with the corresponding mean obtained during the 30 min prior to bafilomycin addition using paired student's *t*-tests as described previously (Grosell and Genz, 2006). In all cases, differences were considered statistically significant at *P*<0.05.

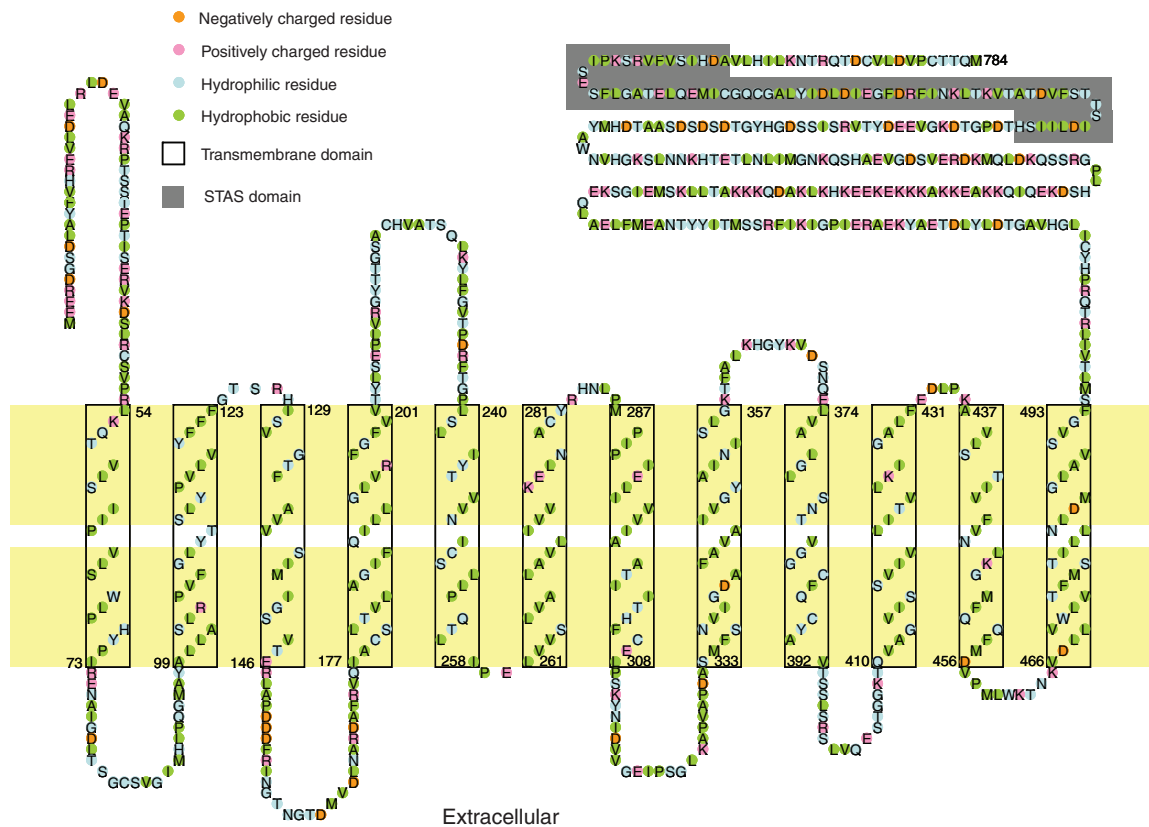

Fig. 2. Predicted amino acid sequence and membrane topology of toadfish SLC26a6 (tfSLC26a6) modified from conpred/TMPred predictions. Assumptions of intracellular amino- and carboxy-terminal domains have been employed (Moseley et al., 1999; Saier et al., 1999) to predict the 12 transmembrane domains that fall within the range of 10–14 transmembrane domains typically predicted for SLC26 proteins (Mount and Romero, 2004). The tfSLC26a6 contains the STAS domain, which has been suggested to function in coordinating SLC26a6 and CFTR function for Cl⁻ and fluid secretion in mammalian systems (Ko et al., 2002; Ko et al., 2004).

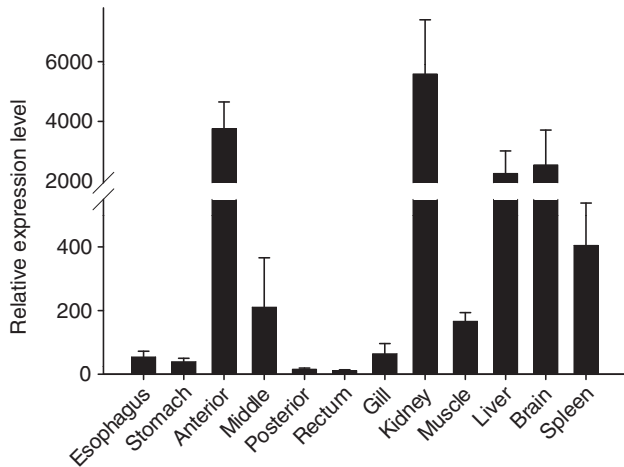

Fig. 3. Tissue distribution of toadfish SLC26a6 mRNA expression. Expression levels normalized to EF1 α are reported relative to the lowest tissue expression level observed (rectum). Means \pm s.e.m., $N=8$.

Results

tSLC26a6

The tfSLC26a6 (EF529734.1) gene codes for a 784 amino acid protein (Fig. 2) and is most strongly expressed in renal tissue and the anterior part of the intestine followed by liver, brain, spleen and more distal intestinal regions (Fig. 3). The translated amino acid sequence displays 71% similarity to the mfSLC26a6A isoform and 58 to 66% similarity to other teleost SLC26a6 amino acid sequences but only 48–49% similarity to amphibian and mammalian orthologs.

Salinity effects on tfSLC26a6 expression

No significant difference in tfSLC26a6 expression was observed in any of the examined tissues or intestinal segments. However, high mean expression levels were observed in the mid intestine at 6–24 h following transfer from seawater to 60 p.p.t. but these were associated with substantial inter-individual variability precluding statistical significance (Fig. 4). The substantial variations in samples of the mid intestine lead us to repeat the RT and qPCR reactions for these samples and to consider two different reference genes (EF1 α and 18S). The variation was observed in both repeat measurements and was not associated with variation in expression levels of the two reference genes, which both exhibited consistent C_T values for all samples and can thus be ascribed to variation in tfSLC26a6. The reported values are means of expression relative of each of the two reference genes (Fig. 4).

Functionality of tfSLC26a6

When expressed in oocytes tfSLC26a6 conducts Cl⁻ uptake consistent with its proposed function in teleost osmoregulation and appears to be electrogenic operating in an nHCO₃⁻/Cl⁻ stoichiometry based on reduced membrane potential in mRNA-injected oocytes (Fig. 5).

An apical vacuolar H⁺-pump in the toadfish intestinal epithelium? Bafilomycin (1 μ mol l⁻¹) increased apparent base secretion in seven of eight preparations. When considering the seven preparations, bafilomycin resulted in a significant (up to 10%) increase in apparent base secretion rate (Fig. 6). Bafilomycin did not influence

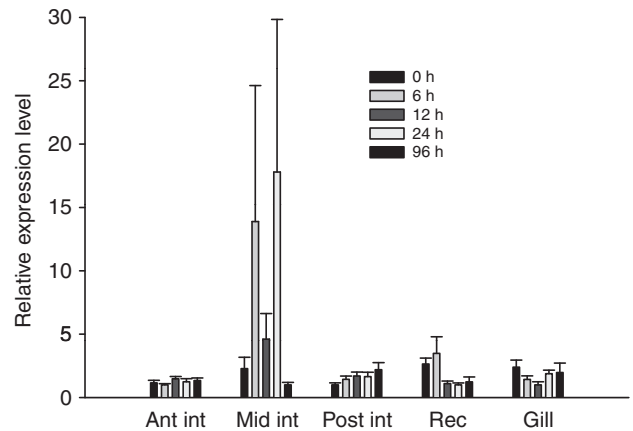

Fig. 4. Expression of toadfish SLC26a6 in anterior (Ant int), mid (Mid int), posterior (Post int) intestine as well as rectum (Rec) and gill following transfer from seawater to 60 p.p.t. Expression levels normalized to EF1 α and 18S are reported relative to the lowest expression level observed in the segment or tissue. Means \pm s.e.m., $N=8$.

the transepithelial potential (TEP) or the epithelial conductance. The single preparation showing no change in base secretion in response to bafilomycin was also unusual by displaying an initially higher TEP, which declined over time (Fig. 6).

The proton pump antibody showed cross-reactivity exclusively with the apical region of the intestinal epithelium (Fig. 7).

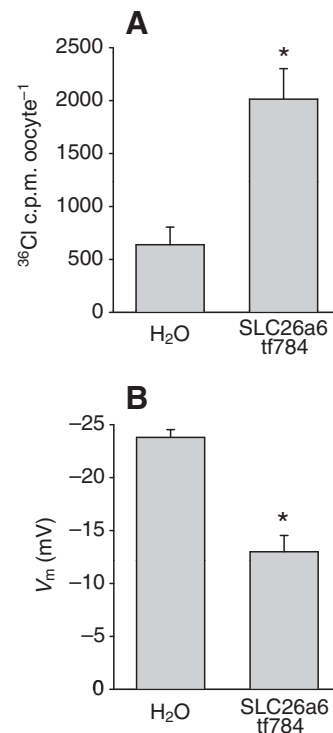

Fig. 5. (A) ³⁶Cl uptake 72 h post-injection of H₂O (control) or toadfish SLC26a6 mRNA by individual *Xenopus* oocytes ($N=14-16$) and (B) membrane potential 48 h post-injections of H₂O (control) or toadfish SLC26a6 mRNA in individual *Xenopus* oocytes ($N=6$). Means \pm s.e.m., *indicates statistically significant difference from control (see text for detail).

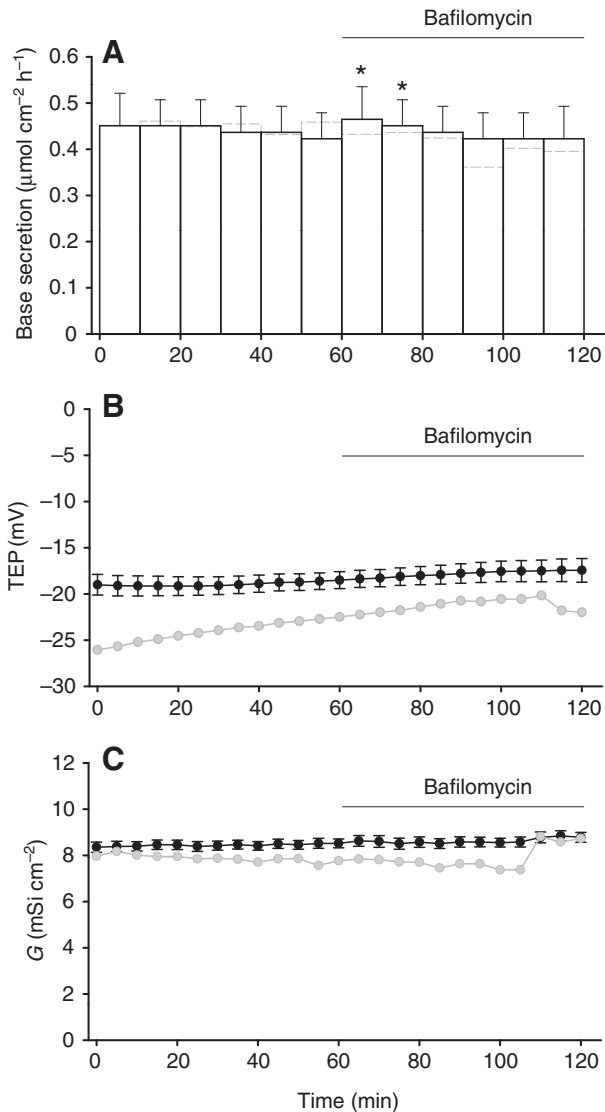

Fig. 6. (A) HCO_3^- secretion, (B) transepithelial potential (TEP) and (C) epithelial conductance (G) in anterior intestinal epithelium from the gulf toadfish *Opsanus beta* under control conditions (0–60 min) and after the addition to $1 \mu\text{mol l}^{-1}$ bafilomycin to the luminal saline (60–120 min). Experiments were performed on a total of eight preparations, of which seven showed a response to bafilomycin addition (black bars, black line, black symbols, means \pm s.e.m., $N=7$). A single preparation (gray bars, gray line, gray symbols) did not respond and was not included in the calculation of means or statistical evaluation. Note that the preparation that did not respond to bafilomycin exhibited an unusual absolute TEP value and declining TEP over time of measurement. *Indicates statistically significant difference from control (see text for detail).

Discussion tfSLC26a6

The relatively low conservation among teleost and vertebrate orthologs appears to be a feature of SLC26 proteins (Mount and Romero, 2004) although all SLC26 members, including tfSLC26a6, contain a C-terminal STAS domain for which the physiological role is largely unknown. The tfSLC26a6 shows the highest similarity to the mfSLC26a6A, which was recently implicated in intestinal HCO_3^- secretion in seawater exposed euryhaline pufferfish (Kurita et al., 2008). In common for these two

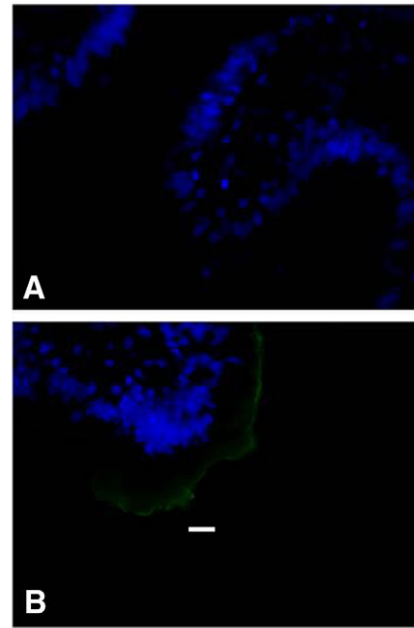

Fig. 7. Localization of the vacuolar H^+ -pump in the anterior intestine of the gulf toadfish by immunohistochemistry. Both panels (A; control without primary antibody and B; H^+ -pump staining) are overlays of two images collected for H^+ -pump immunoreactivity (green) and nuclei visualization by DAPI (blue). Scale bar, $10 \mu\text{m}$.

genes is that they code for an apparently electrogenic anion exchanger (exporting negative charge) and they are highly expressed in the intestinal tissue of teleost fish in seawater. A direct role in base secretion and apical localization in the intestinal epithelium has been demonstrated for mfSLC26a6A (Kurita et al., 2008), and a contribution to intestinal Cl^- absorption by tfSLC26a6 is demonstrated in the present study. In addition, tfSLC26a6 is most strongly expressed in the anterior intestine, which *in vivo* accounts for the majority of the intestinal HCO_3^- secretion (Grosell, 2006; Grosell and Taylor, 2007). Based on these observations it seems highly likely that an electrogenic SLC26a6 anion exchange protein is involved in the high rates of $\text{Cl}^-/\text{HCO}_3^-$ exchange observed in marine teleost fish.

Considering the clear elevation of rectal base excretion by toadfish exposed to 50 p.p.t. compared with seawater (Genz et al., 2008), it is perhaps surprising that no significant elevation in the expression of tfSLC26a6 was observed following transfer from seawater to 60 p.p.t. in the present study. These observations of a lack of transcriptional response are in contrast to reports from the pufferfish (Kurita et al., 2008) and also to observations of elevated tfNBC1 expression in toadfish following exposure to 60 p.p.t. (J.R.T., E.M.M. and M.G., submitted). The differences between gulf toadfish and the pufferfish may be related to the stenohalinity or incomplete euryhalinity in toadfish, which contrasts with the complete euryhalinity of the pufferfish. Furthermore, it is possible that toadfish and even the pufferfish exhibits full expression of SLC26a6 in seawater and that exposure of pufferfish to higher salinities would likewise not result in further elevation of SLC26a6 expression. Recent observations of elevated tfNBC1 following exposure to 60 p.p.t. contrasts the lack of expression change in the present study but tfNBC1 was demonstrated to probably be rate limiting for maximal HCO_3^- secretion rates by isolated intestinal epithelia (J.R.T., E.M.M. and M.G., submitted). Considering that

tfNBC1 is rate limiting for HCO_3^- secretion, it is perhaps less surprising that expression of tfNBC1, and not SLC26a6, is elevated following exposure to 60 p.p.t. Although no significant elevation in tfSLC26a6 expression was observed, it is interesting that the mid intestine tfSLC26a6 expression was elevated in some individuals because the mid intestine is the site of increased expression of tfNBC1.

The SLC26 family of anion exchangers in general displays high substrate promiscuity and this is especially true for SLC26a6 (Jiang et al., 2002; Xie et al., 2002; Mount and Romero, 2004). The marine teleost intestinal anion exchangers therefore may show features distinct from other vertebrate transporters because they operate to absorb Cl^- from luminal fluids of very high SO_4^{2-} and HCO_3^- concentrations, often exceeding Cl^- concentrations, without showing appreciable SO_4^{2-} uptake and with high net base secretion rates. A reasonable prediction of relatively high substrate selectivity of marine teleost SLC26a6 and perhaps other SLC26 members ought to be tested and may offer insight into structure/function relationships of these proteins when compared with mammalian orthologs.

Proton pump/SLC26a6 metabolon?

Here, we present two lines of evidence, bafilomycin sensitivity and immunoreactivity, to support the involvement of an apical vacuolar H^+ -ATPase in gulf toadfish anterior intestinal HCO_3^- secretion. The present observations from toadfish are in agreement with recent evidence from seawater-acclimated trout to strongly implicate an apical H^+ -pump in marine teleost osmoregulation. As discussed above, apical H^+ extrusion by a net base secreting epithelium may seem paradoxical but a more careful consideration leads to the appreciation of its significance. Considering that a substantial fraction of the HCO_3^- secreted by the intestinal epithelium is derived from hydration of endogenous CO_2 , H^+ extrusion is critical for intracellular pH and the continued availability of HCO_3^- . Elimination of H^+ s from the cytosol across the apical, rather than basolateral, membrane will result in a reduction in luminal HCO_3^- concentrations, lessening the adverse gradients opposing continued anion exchange. A novel consideration for Cl^- uptake *via* anion exchange and a coupling to H^+ -ATPase in the light of the recent documentation of electrogenic anion exchangers is that the hyperpolarizing effect of H^+ extrusion may provide an added membrane potential gradient favoring $\text{nHCO}_3^-/\text{Cl}^-$ exchange by electrogenic SLC26a6 proteins. Accepting this view, the argument of SLC26a6 being important for intestinal HCO_3^- secretion against highly adverse gradients is strengthened because the apical H^+ pump will provide energy in the form of enhanced membrane potential gradients for the apical anion exchange.

The idea of a transport metabolon consisting of an apical H^+ pump and apical electrogenic anion exchanger is probably not restricted to intestinal Cl^- and water absorption in marine fish where both Cl^- and HCO_3^- gradients impose challenges for anion exchange.

Freshwater fish of which most, but not all, exhibit Cl^- uptake at the gill (Tomasso and Grosell, 2004; Krogh 1937; Evans et al., 2005) and amphibians that take up Cl^- across the skin from dilute media against substantial electrochemical gradients (Jorgensen et al., 1954; Motais and Garciaro, 1972; Kirschner, 1970) do so *via* anion exchange mechanisms (Marshall and Grosell, 2005; Evans et al., 2005; Jensen et al., 2002; Jensen et al., 2003; Jensen et al., 1997; Larsen et al., 1992). In addition, it is well established that H^+ -pump activity in the apical membrane drives Cl^- uptake in several

freshwater fish species (Fenwick et al., 1999; Boisen et al., 2003) and across the amphibian epidermis (Jensen et al., 2002; Jensen et al., 2003; Larsen et al., 1992). The presence of an electrogenic SLC26a6 in amphibian skin and freshwater fish gills seems likely considering the ability of these organisms to extract Cl^- from low ambient concentrations but this remains to be documented and offers a fruitful area for further study.

A H^+ -pump/SLC26a6 metabolon therefore may serve for Cl^- uptake in freshwater organisms against sizable Cl^- gradients (three orders of magnitude) and both Cl^- uptake and HCO_3^- secretion against gradients by marine teleost intestinal epithelia. In the marine teleost intestine, NaCl absorption drives water uptake by the net movement of osmolytes from the intestinal lumen to the extracellular fluids. Even though a significant portion of the cellular substrate for anion exchange is derived from molecular CO_2 , which is osmotically inert and thus results in a net cellular gain of osmolytes (Cl^-), the $\text{nHCO}_3^-/\text{Cl}^-$ exchange performed by SLC26a6 in isolation would contribute to an elevation of luminal osmotic pressure and thus would impede water absorption. This observation points to an additional adaptive feature of apical H^+ secretion and the H^+ -pump/SLC26a6 coupling in reducing luminal osmotic pressure. The apical H^+ extrusion will facilitate the dehydration of luminal HCO_3^- depleting the concentration of two osmolytes (HCO_3^- and H^+) while elevating the concentration of the osmotically inert CO_2 gas and thereby promoting water absorption. It is noteworthy that the presence of membrane-bound extracellular CA, at least in seawater-acclimated trout, would act to catalyze this dehydration reaction and thus enhance water absorption. The presence of an apical H^+ -pump and CAIV is documented from seawater-acclimated rainbow trout intestine and the presence of an apical electrogenic SLC26a6 and H^+ -pump in toadfish intestine is now evident. However, the presence of both the H^+ -pump, an electrogenic SLC26a6 and CAIV in the same intestinal tissue from a seawater (acclimated) fish, allowing for functional cooperativity to enhance HCO_3^- secretion and Cl^- uptake begs to be demonstrated.

The effect of H^+ -pump inhibition on overall net base secretion was approximately 20% in seawater-acclimated rainbow trout (Grosell et al., 2009) and even more modest (10% and transient) in toadfish as demonstrated in the present study. However, these values probably represent an underestimation of the role of the H^+ -pump, because the inhibition of the pump would result in cellular acidification, elevated HCO_3^- concentrations in the unstirred layer at the apical membrane as well as membrane depolarization; all factors that would limit continued HCO_3^- secretion *via* electrogenic SLC26a6. These factors probably explain the transient nature of the bafilomycin response in toadfish and the overall modest bafilomycin effect in both rainbow trout and toadfish.

H^+ extrusion and CaCO_3 formation: conflicting processes?

The formation of CaCO_3 precipitates in the intestinal lumen was first discussed in 1930 (Smith, 1930) but it was not until much later that the detailed chemical nature of these precipitates was characterized (Walsh et al., 1991). Since then, the presence of CaCO_3 precipitates in marine teleost fish intestinal fluids has been observed in a high number of species and appears to be a general feature for this group of vertebrates (Wilson et al., 2002; Wilson and Grosell, 2003). The combined global piscine production of CaCO_3 , which is eliminated with rectal fluids has recently been estimated to contribute as much as 15% to oceanic CaCO_3 production (Wilson et al., 2009) and also has important physiological implications for individual fish. More than 95% of

NaCl imbibed with seawater to replace osmotically lost water in marine teleosts is absorbed by the gastro-intestinal tract and as much as 85% of the ingested water is absorbed. By contrast, very little Mg^{2+} , SO_4^{2-} and Ca^{2+} are absorbed, leaving the concentrations of Mg^{2+} and SO_4^{2-} in rectal fluids very high. The concentration of Ca^{2+} however is much lower [$2\text{--}5\text{ mmol l}^{-1}$ in most cases (Grosell et al., 2001; Grosell, 2006)] than would be expected from the lack of Ca^{2+} absorption and extensive water absorption. The low Ca^{2+} concentrations are the result of the $CaCO_3$ precipitate formation, which amounts to a reduction of the intestinal fluid osmotic pressure of around 70 mosmol and thus facilitates water absorption (Wilson et al., 2002). In addition, the $CaCO_3$ precipitate formation reduces the intestinal Ca^{2+} absorption, imposing less demand for renal Ca^{2+} elimination.

Considering the adaptive significance of both H^+ secretion (resulting in lower luminal total CO_2 concentration and pH and thereby CO_3^{2-} concentration) and $CaCO_3$ precipitate formation, one obvious question concerns the potential conflict between these two processes. Under physiological conditions *in vivo*, luminal fluid chemistry dictates a CO_3^{2-} concentration of $>8\text{ mmol l}^{-1}$ (Grosell et al., 2009), which is in excess of the concentrations of Ca^{2+} normally observed and it therefore appears that apical H^+ secretion is not limiting $CaCO_3$ formation. However, while both processes (H^+ secretion and $CaCO_3$ formation) act to reduce luminal osmotic pressure and enhance water absorption, there is the potential for these two processes to be counteractive. Consequently, a suggestion of coordination of the two processes seems reasonable. Such coordination could pivot around luminal Ca^{2+} concentrations or luminal osmotic pressure or perhaps both in combination as suggested previously (Grosell et al., 2007). A reasonable prediction might be that high luminal osmotic pressure combined with low Ca^{2+} concentrations would stimulate apical H^+ secretion to enhance HCO_3^- titration and thus reduction in osmotic pressure in a situation where Ca^{2+} may limit $CaCO_3$ formation. Conversely, one might expect reduced apical H^+ secretion under conditions of high luminal Ca^{2+} where elevated luminal alkalinity would be favorable for $CaCO_3$ formation. A third possible factor controlling luminal acid secretion might be intestinal fluid pH. Indeed, reduced luminal pH has been shown to greatly increase net base secretion rates in European flounder, which could be the result of altered H^+ -pump activity (Wilson and Grosell, 2003). In contrast to these observations, however, are reports of constant base secretion independent of luminal pH in the gulf toadfish (Cooper et al., 2006).

Regardless of the mode of regulation of luminal H^+ secretion there is likely to be no conflict between the two processes leading to a reduction in luminal osmotic pressure and they therefore appear to be additive. The reduction in luminal osmotic pressure arising from $CaCO_3$ formation has been estimated to be in the order of 70 mosmol (Wilson et al., 2002). This estimate was based on the difference between Ca^{2+} concentrations to be expected from intestinal water absorption rates with no Ca^{2+} absorption and the Ca^{2+} measured in rectal fluids. The difference between expected and observed Ca^{2+} concentrations was assumed to reflect a loss of CO_3^{2-} ions from the luminal fluids. Additionally, an osmotic coefficient of 0.7 for $CaCO_3$ was included in the estimate of a reduction on luminal osmotic pressure of 70 mosmol (Wilson et al., 2002). However, this value may be an underestimate as the formation of $CaCO_3$ consumes two HCO_3^- ions for each Ca^{2+} ion ($Ca^{2+}+HCO_3^- \rightarrow CaCO_3+H^++HCO_3^- \rightarrow CaCO_3+CO_2+H_2O$). From a difference between expected and observed Ca^{2+} concentrations in luminal fluids of $\sim 50\text{ mmol l}^{-1}$ (Wilson et al., 2002) one would therefore expect a reduction on osmotic pressure of 105 mosmol

($50\text{ mmol l}^{-1}Ca^{2+}+100\text{ mmol l}^{-1}HCO_3^- \times \text{osmotic coefficient of } 0.7$). In addition to this value is the effect of titration of luminal HCO_3^- due to apical H^+ secretion, which ranges from 10–25% (Grosell et al., 2009) of the net base secretion. As luminal HCO_3^- concentrations reach 100 mmol l^{-1} , apical H^+ secretion results in a further reduction of at least 10–25 mosmol for a total combined effect of $CaCO_3$ and H^+ secretion of 115–130 mosmol reduction in luminal osmotic pressure. In a previous review of the literature we established that osmotic pressure in luminal fluids and blood plasma is strongly and proportionally correlated (Grosell and Taylor, 2007). This relationship means that without the reduction of luminal osmotic pressure due to epithelial transport of acid–base equivalents, the blood plasma of marine fish would increase by at least 115–130 mosmol (note that the effect of H^+ secretion is probably an underestimate as discussed above). Such an increase in blood osmotic pressure would be fatal or near fatal to most marine teleosts underscoring the significance of luminal osmotic pressure reduction.

Conclusions

The two marine teleost SLC26a6's characterized to date display apparent electrogenic $nHCO_3^-/Cl^-$ exchange which, especially when coupled with apical H^+ -pump activity, comprise a powerful metabolon possibly explaining the electrochemical uphill Cl^- absorption and HCO_3^- secretion. The coupling between H^+ extrusion *via* apical H^+ -pumps and Cl^- uptake, which is well documented for freshwater fish and amphibians probably also involves electrogenic anion exchange to provide the ability to absorb Cl^- from highly dilute media ($<10\text{ }\mu\text{mol l}^{-1}$).

Future directions

Substrate selectivity and affinity for SLC26a6 and other teleost SLC26 and SLC4 family members will be a fruitful area for further study. Marine teleost transporters are likely to show greater substrate selectivity than mammalian orthologs, and freshwater teleost and amphibian SLC26s involved in Cl^- uptake from freshwater undoubtedly will show very high affinity. Species differences among mammalian SLC26a6s with respect to Cl^- affinity has been documented (Chernova et al., 2005; Clark et al., 2008) but freshwater animals will probably show higher affinity than seen in any mammal. Comparative studies of substrate selectivity and affinity across taxa are bound to shed light on the structure/function relationships of anion exchangers.

We and others have documented the presence of SLC26a6 and SLC26a3 in the intestinal tissue of seawater (acclimated) fish (Kurita et al., 2008) but other SLC26 and SLC4 isoforms are also expressed (EU016213 for tfSLC26a3 and EU016214 for tfSLC4a2). The function of SLC26a3 and other anion exchangers in the marine fish intestinal tissue remains to be identified and clearly is an exciting venue for future study.

Although CA binding sites do not appear to be present in tfSLCA6, the possibility exists that toadfish CAC contains binding motifs that would associate with tfSLCA6. A similar argument could be made for rainbow trout for which the CAC sequence is known but SLC26a6 remains to be revealed. In the latter case it is clear that CAC displays an affinity for the apical region of the enterocytes but it is unknown whether this is due to direct binding to SLC26a6 or other membrane proteins. Cloning and sequencing of the CAC from toadfish (and SLC26a6 from trout) as well as membrane-associated CAs (IV, XIV, XV) to examine possible domains facilitating interactions between CAC, anion exchangers and extracellular membrane-bound CA is an obvious next step.

List of abbreviations

CA	carbonic anhydrase
CAC	cytosolic carbonic anhydrase
DIDS	4,4'-diisothiocyanatostilbene-2,2'-disulphonic acid
lis	lateral interspace
NBC	Na ⁺ :HCO ₃ ⁻ co-transporter
NC	Na ⁺ :Cl ⁻ co-transporter
NHE	Na ⁺ :H ⁺ exchange
NKA	Na ⁺ /K ⁺ -ATPase
NKCC	Na ⁺ :K ⁺ :2Cl ⁻ co-transporter
TEP	transepithelial potential
TJ	tight junction

M.G. is supported by NSF (IOB 0743903) and E.M. is supported by an EPA STAR Fellowship. We are grateful for the assistance with electrophysiological measurements performed on oocytes by Dr Gerhard Dahl and his group at the Miller School of Medicine, University of Miami, for the use of Dr Mike Schmale's microscope and to Ray Hurley and Debbie Fretz for the steady supply of toadfish.

References

- Alper, S. L. (2006). Molecular physiology of SLC4 anion exchangers. *J. Exp. Physiol.* **91**, 153-161.
- Alper, S. L., Chernova, M. N. and Stewart, A. K. (2001). Regulation of Na⁺-independent Cl⁻/HCO₃⁻ exchangers by pH. *JOP* **2**, 171-175.
- Ando, M. and Subramanyam, M. V. V. (1990). Bicarbonate transport systems in the intestine of the seawater eel. *J. Exp. Biol.* **150**, 381-394.
- Becker, H. M. and Deitmer, J. W. (2007). Carbonic anhydrase II increases the activity of the human electrogenic Na⁺/HCO₃⁻ cotransporter. *J. Biol. Chem.* **282**, 13508-13521.
- Boisen, A. M., Amstrup, J., Novak, I. and Grosell, M. (2003). Sodium and chloride transport in soft water and hard water acclimated zebrafish (*Danio rerio*). *Biochim. Biophys. Acta* **1618**, 207-218.
- Chernova, M. N., Jiang, L., Friedman, D. J., Darman, R. B., Lohi, H., Kere, J., Vandorpe, D. H. and Alper, S. L. (2005). Functional comparison of mouse SLC26A6 anion exchanger with human SLC26A6 polypeptide variants: differences in anion selectivity, regulation, and electrogenicity. *J. Biol. Chem.* **280**, 8564-8580.
- Clark, J. S., Vandorpe, D. H., Chernova, M. N., Heneghan, J. F., Stewart, A. K. and Alper, S. L. (2008). Species differences in Cl⁻ affinity and in electrogenicity of SLC26A6-mediated oxalate/Cl⁻ exchange correlate with the distinct human and mouse susceptibilities to nephrolithiasis. *J. Physiol.* **586**, 1291-1306.
- Colin, D. A., Nonnotte, G., Leray, C. and Nonnotte, L. (1985). Na-transport and enzyme-activities in the intestine of the fresh-water and sea-water adapted trout (*Salmo-Gairdneri* R). *Comp. Biochem. Physiol. A* **81**, 695-698.
- Cooper, C. A., Bury, N. R. and Grosell, M. (2006). The effects of pH and the iron redox state on iron uptake in the intestine of a marine teleost fish, gulf toadfish (*Opsanus beta*). *Comp. Biochem. Physiol. A* **143**, 292-298.
- Cutler, C. P. and Cramb, G. (2002). Two isoforms of the Na⁺/K⁺/2Cl⁻ cotransporter (NKCC1) are expressed in the European eel (*Anguilla anguilla*). *Biochim. Biophys. Acta* **1566**, 92-103.
- Dixon, J. M. and Loretz, C. A. (1986). Luminal alkalization in the intestine of the goby. *J. Comp. Physiol.* **156**, 803-811.
- Evans, D. H., Piermarini, P. M. and Choe, K. P. (2005). The multifunctional fish gill: dominant site of gas exchange, osmoregulation, acid-base regulation, and excretion of nitrogenous waste. *Physiol. Rev.* **85**, 97-177.
- Fenwick, J. C., Wendelaar Bonga, S. E. and Flick, G. (1999). *In vivo* bafilomycin-sensitive Na⁺ uptake in young freshwater fish. *J. Exp. Biol.* **202**, 3659-3666.
- Field, M., Smith, P. L. and Bolton, J. E. (1980). Ion transport across the isolated intestinal mucosa of the winter flounder *Pseudopleuronectes americanus*: II. Effects of cyclic AMP. *J. Membr. Biol.* **53**, 157-163.
- Frizzell, R. A., Smith, P. L., Vosburgh, E. and Field, M. (1979). Coupled sodium-chloride influx across brush border of flounder intestine. *J. Membr. Biol.* **46**, 27-39.
- Fuentes, J., Soengas, J. L., Rey, P. and Rebollo, E. (1997). Progressive transfer to seawater enhances intestinal and branchial Na⁺-K⁺ ATPase activity in non-anadromous rainbow trout. *Aquac. Int.* **5**, 217-227.
- Genz, J., Taylor, J. R. and Grosell, M. (2008). Effects of salinity on intestinal bicarbonate secretion and compensatory regulation of acid-base balance in *Opsanus beta*. *J. Exp. Biol.* **211**, 2327-2335.
- Grosell, M. (2006). Intestinal anion exchange in marine fish osmoregulation. *J. Exp. Biol.* **209**, 2813-2827.
- Grosell, M. (2007). Intestinal transport processes in marine fish osmoregulation. In *Fish Osmoregulation* (ed. Bernardo Baldisserotto, Juan Miquel Mancera and B. G. Kapoor), pp. 332-357. Enfield, NH: Science Publishers.
- Grosell, M. and Genz, J. (2006). Ouabain sensitive bicarbonate secretion and acid absorption by the marine fish intestine play a role in osmoregulation. *Am. J. Physiol.* **291**, R1145-R1156.
- Grosell, M. and Jensen, F. B. (1999). NO₂⁻ uptake and HCO₃⁻ excretion in the intestine of the European flounder (*Platichthys flesus*). *J. Exp. Biol.* **202**, 2103-2110.
- Grosell, M. and Taylor, J. R. (2007). Intestinal anion exchange in teleost water balance. *Comp. Biochem. Physiol.* **148**, 14-22.
- Grosell, M., De Boeck, G., Johannsson, O. and Wood, C. M. (1999). The effects of silver on intestinal ion and acid-base regulation in the marine teleost fish, *Papophrys vetulus*. *Comp. Biochem. Physiol. C* **124**, 259-270.
- Grosell, M., Laliberte, C. N., Wood, S., Jensen, F. B. and Wood, C. M. (2001). Intestinal HCO₃⁻ secretion in marine teleost fish: evidence for an apical rather than a basolateral Cl⁻/HCO₃⁻ exchanger. *Fish Physiol. Biochem.* **24**, 81-95.
- Grosell, M., Wood, C. M., Wilson, R. W., Bury, N. R., Hogstrand, C., Rankin, C. and Jensen, F. B. (2005). Bicarbonate secretion plays a role in chloride and water absorption of the European flounder intestine. *Am. J. Physiol. Regul. Integr. Comp. Physiol.* **288**, R936-R946.
- Grosell, M., Gilmour, K. M. and Perry, S. F. (2007). Intestinal carbonic anhydrase, bicarbonate, and proton carriers play a role in the acclimation of rainbow trout to seawater. *Am. J. Physiol.* **293**, R2099-R2111.
- Grosell, M., Genz, J., Taylor, J. R., Perry, S. F. and Gilmour, K. M. (2009). The involvement of H⁺-ATPase and carbonic anhydrase in intestinal HCO₃⁻ secretion in seawater acclimated rainbow trout. *J. Exp. Biol.* (in press).
- Guizouarn, H., Christen, R. and Borgese, F. (2005). Phylogeny of anion exchangers: could trout AE1 conductive properties be shared by other members of the gene family? *Biochim. Biophys. Acta* **1726**, 244-250.
- Halm, D. R., Krasny, E. J. and Frizzell, R. A. (1985). Electrophysiology of flounder intestinal mucosa. II. Relation of the electrical potential profile to coupled NaCl absorption. *J. Gen. Physiol.* **85**, 865-883.
- Höglund, P., Haila, S., Socha, J., Tomaszewski, L., Saarialho-Kere, U., Karjalainen-Lindsberg, M. L., Airola, K., Holmberg, C., de al Chapelle, A. and Kere, J. (1996). Mutations of the down-regulated in adenoma (DRA) gene cause congenital chloride diarrhoea. *Nat. Genet.* **14**, 316-319.
- Hogstrand, C., Ferguson, E. A., Galvez, F., Shaw, J. R., Webb, N. A. and Wood, C. M. (1999). Physiology of acute silver toxicity in the starry flounder (*Platichthys stellatus*) in seawater. *J. Comp. Physiol. B* **169**, 461-473.
- Humphreys, B. D., Jiang, L., Chernova, M. N. and Alper, S. L. (1994). Functional characterization and regulation by Ph of murine Ae2 anion-exchanger expressed in *Xenopus* oocytes. *Am. J. Phys.* **36**, C1295-C1307.
- Jampol, L. M. and Epstein, F. H. (1970). Sodium-potassium-activated adenosine triphosphate and osmotic regulation by fishes. *Am. J. Physiol.* **218**, 607-611.
- Jensen, L. J., Sørensen, J. N., Larsen, E. H. and Willumsen, N. J. (1997). Proton pump activity of mitochondria-rich cells: the interpretation of external proton-concentration gradients. *J. Gen. Physiol.* **109**, 73-91.
- Jensen, L. J., Willumsen, N. J. and Larsen, E. H. (2002). Proton pump activity is required for active uptake of chloride in isolated amphibian skin exposed to freshwater. *J. Comp. Physiol. B* **176**, 503-511.
- Jensen, L. J., Willumsen, N. J., Amstrup, J. and Larsen, E. H. (2003). Proton pump-driven cutaneous chloride uptake in anuran amphibians. *Biochim. Biophys. Acta* **1618**, 120-132.
- Jiang, Z., Grichtchenko, I. I., Boron, W. F. and Aronson, P. S. (2002). Specificity of anion exchange mediated by mouse SLC26A6. *J. Biol. Chem.* **277**, 33963-33967.
- Jorgensen, C. B., Levi, H. and Zerahn, K. (1954). On active uptake of sodium and chloride ions in anurans. *Acta Physiol. Scand.* **30**, 178-190.
- Kelly, S. P., Chow, I. N. K. and Woo, N. Y. S. (1999). Haloplasticity of black seabream (*Mylio macrocephalus*): hypersaline to freshwater acclimation. *J. Exp. Zool.* **283**, 226-241.
- Kirschner, L. B. (1970). The study of NaCl in aquatic animals. *Am. Zool.* **10**, 365-376.
- Knauf, F., Yang, C. L., Thompson, R. B., Mentone, S. A., Giebisch, G. and Aronson, P. S. (2001). Identification of a chloride-formate exchanger expressed on the brush border membrane of renal proximal tubule cells. *Proc. Natl. Acad. Sci. USA* **98**, 9425-9430.
- Ko, S. B., Shcheynikov, N., Choi, J. Y., Luo, X., Ishibashi, K., Thomas, P. J., Kim, J. Y., Kim, K. H., Lee, M. G., Naruse, S. et al. (2002). A molecular mechanism for aberrant CFTR-dependent HCO₃⁻ transport in cystic fibrosis. *EMBO J.* **21**, 5662-5672.
- Ko, S. B., Zeng, W., Dorwart, M. R., Luo, X., Kim, K. H., Millen, L., Goto, H., Naruse, S., Soyombo, A., Thomas, P. J. et al. (2004). Gating of CFTR by the STAS domain of SLC26 transporters. *Nat. Cell Biol.* **6**, 343-350.
- Krogh, A. (1937). Osmotic regulation in fresh water fishes by active absorption of chloride ions. *Z. Vgl. Physiol.* **24**, 656-666.
- Kurita, Y., Nakada, T., Kato, A., Doi, H., Mistry, A. C., Chang, M. H., Romero, M. F. and Hirose, S. (2008). Identification of intestinal bicarbonate transporters involved in formation of carbonate precipitates to stimulate water absorption in marine teleost fish. *Am. J. Physiol.* **294**, R1402-R1412.
- Larsen, E. H., Willumsen, N. J. and Christoffersen, B. C. (1992). Role of proton pump of mitochondria-rich cells for active transport of chloride ions in toad skin epithelium. *J. Physiol.* **450**, 203-216.
- Livak, K. J. and Schmittgen, T. D. (2001). Analysis of relative gene expression data using real-time quantitative PCR and the 2^{-ΔΔCT} method. *Methods* **25**, 402-408.
- Lohi, H., Kujala, M., Kerkelä, E., Saarialho-Kere, U., Kestilä, M. and Kere, J. (2000). Mapping of five new putative anion transporter genes in human and characterization of SLC26A6, a candidate gene for pancreatic anion exchanger. *Genomics* **70**, 102-112.
- Loretz, C. A. (1995). Electrophysiology of ion transport in the teleost intestinal cells. In *Cellular and Molecular Approaches to Fish Ionic Regulation* (ed. C. M. Wood and T. J. Shuttleworth), pp. 25-56. Toronto: Academic Press.
- Loretz, C. A. and Fournier, C. R. (1988). Functional characterization of a voltage-gated anion channel from teleost fish intestinal epithelium. *J. Exp. Biol.* **136**, 383-403.
- Lu, J., Daly, C. M., Parker, M. D., Gill, H. S., Piermarini, P. M., Pelletier, M. F. and Boron, W. F. (2006). Effect of human carbonic anhydrase II on the activity of the human electrogenic Na/HCO₃ cotransporter NBCe1-A in *Xenopus* oocytes. *J. Biol. Chem.* **281**, 19241-19250.
- Mackay, W. C. and Janicki, R. (1978). Changes in the eel intestine during seawater adaptation. *Comp. Biochem. Physiol.* **62A**, 757-761.
- Madsen, S. S., McCormick, S. D., Young, G., Andersen, J. S., Nishioka, R. and Bern, H. A. (1994). Physiology of seawater acclimation in the striped bass, *Morone saxatilis* (Walbaum). *Fish Physiol. Biochem.* **13**, 1-11.
- Marshall, W. S. and Grosell, M. (2005). Ion transport, osmoregulation and acid-base balance. In *The Physiology of Fishes*, 3rd edn (ed. D. Evans and J. B. Claiborne). Boca Raton, FL: CRC Press.

- Marshall, W. S., Howard, J. A., Cozzi, R. R. and Lynch, E. M. (2002). NaCl and fluid secretion by the intestine of the teleost *Fundulus heteroclitus*: involvement of CFTR. *J. Exp. Biol.* **205**, 745-758.
- Maxime, V., Pennec, J. P. and Peyraud, C. (1991). Effects of direct transfer from fresh-water to seawater on respiratory and circulatory variables and acid-base status in rainbow trout. *J. Comp. Physiol. B* **161**, 557-568.
- McDonald, M. D. and Grosell, M. (2006). Maintaining osmotic balance with an aglomerular kidney. *Comp. Biochem. Physiol. A* **143**, 447-458.
- McMurtrie, H. L., Cleary, H. J., Alvarez, B. V., Loisele, F. B., Sterling, D., Morgan, P. E., Johnson, D. E. and Casey, J. R. (2004). The bicarbonate transport metabolon. *J. Enzyme Inhib. Med. Chem.* **19**, 231-236.
- Melvin, J. E., Park, K., Richardson, L., Schultheis, P. J. and Shull, G. E. (1999). Mouse down-regulated in adenoma (DRA) is an intestinal $\text{Cl}^-/\text{HCO}_3^-$ exchanger and is up-regulated in colon of mice lacking the NHE3 Na^+/H^+ exchanger. *J. Biol. Chem.* **274**, 22855-22861.
- Moseley, R. H., Höglund, P., Wu, G. D., Silberg, D. G., Haila, S., de la Chapelle, A., Holmberg, C. and Kere, J. (1999). Downregulated in adenoma gene encodes a chloride transporter defective in congenital chloride diarrhea. *Am. J. Physiol.* **276**, G185-G192.
- Motais, R. and Garciaro, F. (1972). Transport mechanisms in teleostean gill and amphibian skin. *Annu. Rev. Physiol.* **34**, 141-176.
- Mount, D. B. and Romero, M. F. (2004). The SLC26 gene family of multifunctional anion exchangers. *Pflügers Arch.* **447**, 710-721.
- Musch, M. W. and Goldstein, L. (2005). Tyrosine kinase inhibition affects skate anion exchanger isoform 1 alterations after volume expansion. *Am. J. Physiol.* **288**, R885-R890.
- Musch, M. W., Orellana, S. A., Kimberg, L. S., Field, M., Halm, D. R., Krasny, E. J., Jr and Frizzell, R. A. (1982). $\text{Na}^+/\text{K}^+/\text{2Cl}^-$ co-transport in the intestine of a marine teleost. *Nature* **300**, 351-353.
- Nonnotte, G. and Truchot, J. P. (1990). Time course of extracellular acid-base adjustments under hypoosmotic or hyperosmotic conditions in the euryhaline fish *Platichthys flesus*. *J. Fish Biol.* **36**, 181-190.
- Pelis, R. M. and Renfro, J. L. (2003). Active sulfate secretion by the intestine of winter flounder is through exchange for luminal chloride. *Am. J. Physiol.* **284**, R380-R388.
- Piermarini, P. M., Verlander, J. W., Royaux, I. E. and Evans, D. H. (2002). Pendrin immunoreactivity in the gill epithelium of a euryhaline elasmobranch. *Am. J. Physiol.* **283**, R983-R992.
- Piermarini, P. M., Kim, E. Y. and Boron, W. F. (2007). Evidence against a direct interaction between intracellular carbonic anhydrase II and pure C-terminal domains of SLC4 bicarbonate transporters. *J. Biol. Chem.* **282**, 1409-1421.
- Renfro, J. L. and Pritchard, J. B. (1983). Sulfate transport by flounder renal tubule brush border: presence of anion exchange. *Am. J. Physiol.* **244**, F488-F496.
- Romero, M. F., Fulton, C. M. and Boron, W. F. (2004). The SLC4 family of HCO_3^- transporters. *Pflügers Arch.* **447**, 495-509.
- Saier, M. H., Jr, Eng, B. H., Fard, S., Garg, J., Haggerty, D. A., Hutchinson, W. J., Jack, D. L., Lai, E. C., Liu, H. J., Nusinew, D. P. et al. (1999). Phylogenetic characterization of novel transport protein families revealed by genome analyses. *Biochim. Biophys. Acta* **1422**, 1-56.
- Scott, G. R., Baker, D. W., Schulte, P. M. and Wood, C. M. (2008). Physiological and molecular mechanisms of osmoregulatory plasticity in killifish after seawater transfer. *J. Exp. Biol.* **211**, 2450-2459.
- Shmukler, B. E., Kurschat, C. E., Ackermann, G. E., Jiang, L., Zhou, Y., Barut, B., Stuart-Tilley, A. K., Zhao, J., Zon, L. I., Drummond, I. A. et al. (2005). Zebrafish *slc4a2/ae2* anion exchanger: cDNA cloning, mapping, functional characterization, and localization. *Am. J. Physiol.* **289**, F835-F849.
- Skadhauge, E. (1974). Coupling of transmural flows of NaCl and water in the intestine of the eel (*Anguilla anguilla*). *J. Exp. Biol.* **60**, 535-546.
- Smith, H. W. (1930). The absorption and excretion of water and salts by marine teleosts. *Am. J. Physiol.* **93**, 480-505.
- Sterling, D., Reitmeier, R. A. F. and Casey, J. R. (2001). A transport metabolon. *J. Biol. Chem.* **276**, 47886-47894.
- Sterling, D., Brown, N. J., Supuran, C. T. and Casey, J. R. (2002). The functional and physical relationship between the DRA bicarbonate transporter and carbonic anhydrase II. *Am. J. Physiol.* **283**, C1522-C1529.
- Taylor, J. R. and Grosell, M. (2006). Evolutionary aspects of intestinal bicarbonate secretion in fish. *Comp. Biochem. Physiol. A* **143**, 523-529.
- Tomasso, J. R. and Grosell, M. (2004). Physiological basis for large differences in resistance to nitrite among freshwater and freshwater acclimated euryhaline fishes. *Environ. Sci. Technol.* **39**, 98-102.
- Usher, M. L., Talbot, C. and Eddy, F. B. (1991). Intestinal water transport in juvenile atlantic salmon (*Salmo salar* L.) during smolting and following transfer to seawater. *Comp. Biochem. Physiol.* **100A**, 813-818.
- Vandesompele, J., De Preter, K., Pattyn, F., Poppe, B., Van Roy, N., De Paeppe and Speleman, F. A. (2002). Accurate normalization of real-time quantitative RT-PCR data by geometric averaging of multiple internal control genes. *Genome Biol.* **3**, RESEARCH0034.
- Waldegger, S., Moschen, I., Ramirez, A., Smith, R. J., Ayadi, H., Lang, F. and Kubisch, C. (2001). Cloning and characterization of SLC26A6, a novel member of the solute carrier 26 gene family. *Genomics* **72**, 43-50.
- Walsh, P. J., Blackwelder, P., Gill, K. A., Danulat, E. and Mommson, T. P. (1991). Carbonate deposits in marine fish intestines: a new source of biomineralization. *Limnol. Oceanogr.* **36**, 1227-1232.
- Wang, J., Ma, M., Locovei, S., Keane, R. W. and Dahl, G. (2007). Modulation of membrane channel currents by gap junction protein mimetic peptides: size matters. *Am. J. Physiol.* **293**, C1112-C1119.
- Wang, Y., Henry, R. P., Wright, P. M., Heigenhauser, G. J. and Wood, C. M. (1998). Respiratory and metabolic functions of carbonic anhydrase in exercised white muscle of trout. *Am. J. Physiol.* **275**, R1766-R1779.
- Wilkes, P. R. H. and McMahon, B. R. (1986). Responses of a stenohaline fresh-water teleost (*Catostomus commersoni*) to hypersaline exposure. 1. The dependence of plasma pH and bicarbonate concentration on electrolyte regulation. *J. Exp. Biol.* **121**, 77-94.
- Wilson, J. M., Laurent, P., Tufts, B. L., Benos, D. J., Donowitz, M., Vogl, A. W. and Randall, D. J. (2000). NaCl uptake by the branchial epithelium in freshwater teleost fish: an immunological approach to ion-transport protein localization. *J. Exp. Biol.* **203**, 2279-2296.
- Wilson, R. W. (1999). A novel role for the gut of seawater teleosts in acid-base balance. In *Regulation of Acid-Base Status in Animals and Plants* (ed. S. Egginton, E. W. Taylor and J. A. Ravem), pp. 257-274. Cambridge: Cambridge University Press.
- Wilson, R. W. and Grosell, M. (2003). Intestinal bicarbonate secretion in marine teleost fish-source of bicarbonate, pH sensitivity, and consequence for whole animal acid-base and divalent cation homeostasis. *Biochim. Biophys. Acta* **1618**, 163-193.
- Wilson, R. W., Gilmour, K., Henry, R. and Wood, C. (1996). Intestinal base excretion in the seawater-adapted rainbow trout: a role in acid-base balance? *J. Exp. Biol.* **199**, 2331-2343.
- Wilson, R. W., Wilson, J. M. and Grosell, M. (2002). Intestinal bicarbonate secretion by marine teleost fish-why and how? *Biochim. Biophys. Acta* **1566**, 182-193.
- Wilson, R. W., Millero, F. J., Taylor, J. R., Walsh, P. J., Christensen, V., Jennings S. and Grosell, M. (2009). Contribution of fish to the marine inorganic carbon cycle. *Science* **323**, 359-362.
- Xie, Q., Welch, R., Mercado, A., Romero, M. F. and Mount, D. B. (2002). Molecular characterization of the murine SLC26a6 anion exchanger, functional comparison to *slc26a1*. *Am. J. Physiol.* **283**, F826-F838.
- Xu, H., Chen, H., Dong, J., Lynch, R. and Ghishan, F. K. (2008). Gastrointestinal distribution and kinetic characterization of the sodium-hydrogen exchanger isoform 8 (NHE8). *Cell. Physiol. Biochem.* **21**, 109-116.
- Zachos, N. C., Tse, M. and Donowitz, M. (2005). Molecular physiology of intestinal Na^+/H^+ exchange. *Annu. Rev. Physiol.* **67**, 411-443.
- Zuidema, T., Kamermans, M. and Vanheukelom, J. S. (1986). Influence of glucose-absorption on ion activities in cells and submucosal space in goldfish intestine. *Pflügers Arch.* **407**, 292-298.