

DYNAMIC OSCILLATIONS IN THE MEMBRANE POTENTIAL OF PANCREATIC ISLET CELLS

BY E. K. MATTHEWS AND M. D. L. O'CONNOR*

*Department of Pharmacology, University of Cambridge,
Medical School, Hills Road, Cambridge CB2 2QD*

SUMMARY

Glucose and other metabolizable sugars which elicit insulin release from the β -cell of the pancreatic islet induce repetitive oscillations in the β -cell transmembrane potential. Upon each phasic depolarization are superimposed rapid fluctuations in potential, i.e. 'action potentials' or 'spikes' which occur as bursts of electrical activity; the duration and frequency of each burst is a function of glucose concentration. These established electrophysiological features of glucose-islet cell interaction are described in detail together with a consideration of their possible molecular and ionic basis. Based on these observations, a dynamic mathematical computer model of the β -cell membrane electrical behaviour is presented which utilizes the Goldman equation extended to include divalent ions. The model illustrates how the ionic mechanisms deduced from experimental observations can account for the electrical patterns produced by the β -cells in the presence of D-glucose; it also allows systematic changes to be made in a number of state variables in order to assess their relative importance and possible contribution to the integrated processes actually observed. Finally, distinction is made between aspects of the model which are well supported by experimental results and those areas which require further analysis.

INTRODUCTION

The β -cell of the pancreatic islet responds to a wide variety of stimuli with the release of insulin. Measurements of the electrical properties of the islet β -cell membrane have been made in a number of different animal species using microelectrodes *in vitro*. These studies have revealed that certain stimulant molecules initiate periodic changes in the membrane potential which lead to the appearance of 'action potentials' or 'spikes', i.e. rapid fluctuations of potential superimposed upon some new basal potential value (Dean & Matthews, 1968, 1970*a, b*; Dean, Matthews & Sakamoto, 1975; Pace & Price, 1972, 1974; Meissner & Schmeltz, 1974; Atwater & Beigelman, 1976; Beigelman, Ribalet & Atwater, 1977). Furthermore, a close relationship exists between the ability of D-glucose, the normal physiological stimulant of the β -cell, to induce this oscillatory behaviour in membrane electrical activity and to elicit insulin release (Dean & Matthews, 1970*a*; Matthews & Dean, 1970; Meissner & Schmeltz, 1974; Meissner & Atwater,

* NIH Postdoctoral Research Fellow.

1976). In view of the functional significance of this relationship and its important implications for the abnormal cellular response (i.e. in diabetes mellitus) this aspect of β -cell activity has been closely investigated in recent years (see Matthews, 1977). The experimental evidence is now sufficiently detailed to allow the construction of a dynamic model based on these observations. The benefits of this systematic approach, although like any theoretical interpretation liable to subsequent modification or eventual replacement, are that it may help to clarify the operational characteristics of the various interacting processes involved as well as highlighting the areas requiring further experimental definition. With this in mind it is our intention here to:

- (i) describe the established experimental observations relating to the electrophysiological aspects of glucose-islet cell interaction,
- (ii) consider possible molecular and ionic explanations for them, and
- (iii) construct a theoretical model based on (i) and (ii) which enables a systematic change to be made in a number of state variables in order to assess their relative importance and possible contribution to the processes observed.

PANCREATIC ISLET CELLS: GLUCOSE-INDUCED CHANGES IN MEMBRANE POTENTIAL

With recent improvements in microelectrode techniques it is now established that the membrane potential of the pancreatic β -cell, although somewhat variable from cell to cell, is in the region of -40 to -50 mV (inside, with respect to outside) as long as the extracellular glucose concentration is maintained at a low basal level, e.g. 2.8 mM. In the total absence of glucose the cell polarizes to values in excess of this and may reach potentials of ≥ -60 mV (Matthews & Sakamoto, 1975*a, b*; Meissner, 1976*a*; Beigelman *et al.* 1977), see below. In contrast, at a threshold of approximately 4 mM, following an initial depolarization of the membrane from the level in glucose 2.8 mM, the cell shows a typical pattern of spike discharge. With large increases in glucose concentration, e.g. a tenfold increase to 28 mM, the spike discharge becomes continuous as the cell depolarizes to a relatively new stable level of membrane potential from which 'action potentials' arise (Fig. 1). However, just above the threshold of 4 mM there is a progressive increase in both the number of cells that show electrical activity (Dean & Matthews, 1970*a*; Beigelman *et al.* 1977), and between 5.6 and 16.6 mM glucose the frequency at which bursts of electrical activity appear (Dean & Matthews, 1970*a*; Dean *et al.* 1975; Meissner & Schmeltz, 1974; Beigelman *et al.* 1977). At the concentration of glucose which is approximately half-maximal for insulin release, 11.1 mM, the electrical activity occurs in well-defined bursts. A typical record appears in Fig. 2. At this concentration of glucose each burst of electrical activity has a duration of at least 5 s (Matthews, Dean & Sakamoto, 1973; Meissner, 1976*a*; Beigelman *et al.* 1977) and is succeeded by a silent period of approximately the same length, giving a burst repetition rate of approximately 6 per min with remarkably regular periodicity.

It can be seen from Fig. 2 that preceding each burst is a slow depolarization (reminiscent of the prepotential in both cardiac and smooth muscle cells) that at some threshold value markedly accelerates in rate to reach a plateau potential. Arising from the plateau are spikes with a frequency of discharge that is generally greater at the beginning than at the end of the burst (see Fig. 2). The period of 'action potential' discharge or spiking

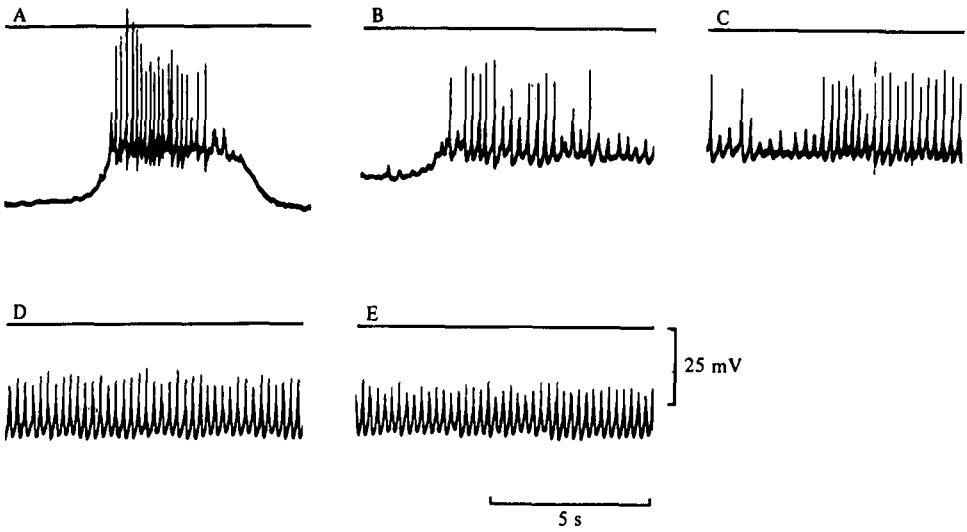

Fig. 1. Electrical activity induced in a mouse pancreatic islet cell by D-glucose. Intracellular records from the same cell: A-E, 6, 8, 10, 15 and 20 min, respectively, after exposure to D-glucose 28 mM. The horizontal line indicates the zero potential. From Dean, Matthews & Sakamoto (1975).

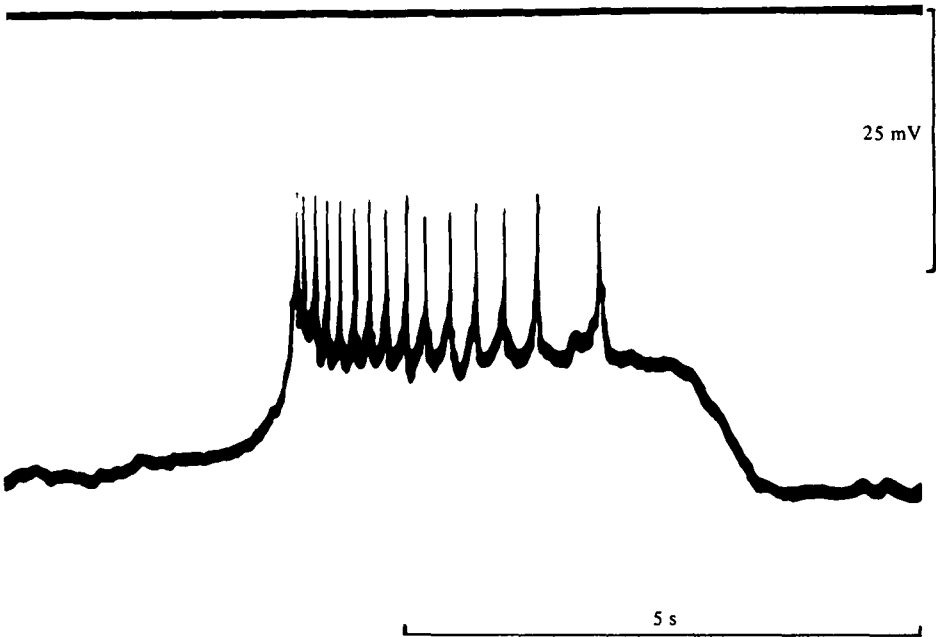

Fig. 2. Electrical activity induced in a mouse pancreatic islet cell by D-glucose, 11.1 mM. Intracellular recording after 20 min exposure to D-glucose. The horizontal line indicates the zero potential. From Matthews, Dean & Sakamoto (1973).

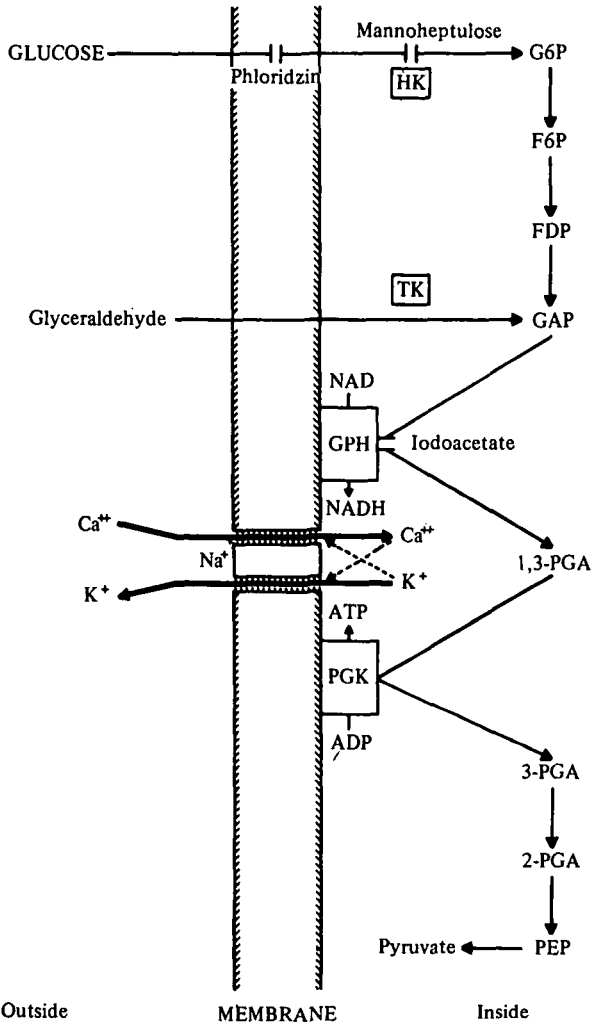

Fig. 3. A model system for the interaction of glycolysis and membrane cation permeability. The activity of glyceraldehyde phosphate dehydrogenase (GPH)–phosphoglycerate kinase (PGK), located at or near the cell membrane, may initiate a conductance change by a localized fluctuation of redox equilibrium (NAD^+/NADH), H^+ ion concentration, ATP, or phosphate concentration in the immediate submembrane space. This would account for the observed decrease of islet cell K^+ permeability in the presence of glucose. Various feedback pathways and mechanisms for cationic and anionic permeability control may be incorporated into this model but only the proposed Ca–K interaction is indicated here. From Matthews (1975).

then ceases as repolarization intervenes and the potential returns to that of the 'silent' phase prior to a further burst of activity. In some cases the membrane at the beginning of the plateau is slightly more depolarized than near the end of the plateau (see Meissner, 1976a).

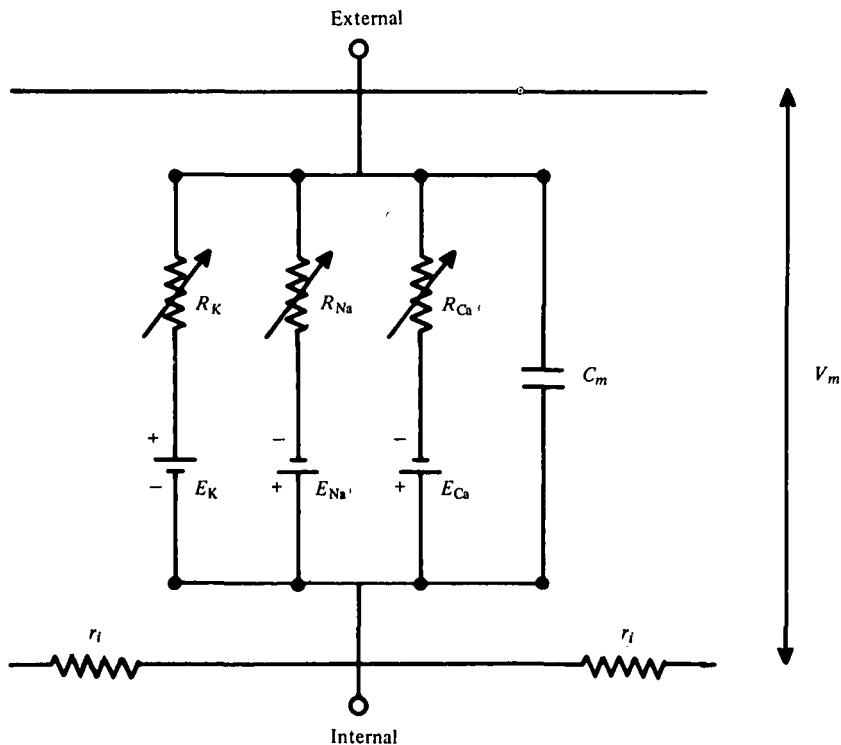

Fig. 4. Equivalent electric circuit across the β -cell membrane, representing distributed resistance, capacitance and ionic E.M.F. E , Equilibrium potential for each ion; R , the corresponding resistance ($R = 1/g$, where g = conductance); C_m , membrane capacitance, and V_m , the membrane potential. The internal resistance r_i indicates possible low resistance pathways for electrical coupling between β -cells as demonstrated by Meissner (1976*a*). From Matthews (1979).

PANCREATIC ISLET CELLS: CONTROL MECHANISMS FOR OSCILLATIONS IN MEMBRANE POTENTIAL

The repetitive oscillations in islet cell membrane potential described above are characteristic of the action of glucose and other metabolizable sugars that elicit insulin release. Mechanisms for the interaction of glycolysis and membrane cation permeability have been proposed (see Dean *et al.* 1975; Matthews, 1975, 1977) and are summarized in Fig. 3. In theory the glucose-induced depolarization and initiation of electrical activity may involve an increased influx of Na^+ or Ca^{2+} , a decreased efflux of K^+ , or an increased efflux of Cl^- . Conversely the subsequent hyperpolarization and suppression of spike activity may be associated with a decreased influx of Na^+ or Ca^{2+} , an increased efflux of K^+ or an increased influx of Cl^- . Conceivably, each process may be passive, active or electrogenic. However, a number of these possibilities, if not eliminated entirely by experimental observations, are certainly rendered less significant than others.

For example, replacement of $[\text{Cl}^-]_o$ by the relatively impermeant anion isethionate does not modify the membrane potential or prevent the appearance of glucose-induced electrical activity (Dean & Matthews, 1970*b*; Matthews & Sakamoto, 1975*b*); in certain

circumstances electrical activity may even be enhanced (Matthews & Sakamoto, 1975*b*). Similarly the spikes still appear in the presence of the Na-channel blocker tetrodotoxin (Meissner & Schmeltz, 1974) and are even increased in amplitude in low $[Na]_o$ (Dean & Matthews, 1970*b*). These and other observations, including the attenuation or disappearance of burst and spike activity after $[Ca^{2+}]_o$ removal, or treatment with the Ca^{2+} -antagonist D600 (Dean & Matthews, 1970*b*; Matthews & Sakamoto, 1975*b*), indicate that the major ion entering the cell during glucose-induced spiking is Ca^{2+} (see Matthews, 1975, 1977), although *some* changes in Na influx are also implicated either through Na or Na/Ca channels (Donatsch *et al.* 1977). On the other hand, the membrane potential itself is determined primarily by the K^+ distribution (Dean & Matthews, 1970*b*; Atwater, Ribalet & Rojas, 1978). Taking this and the previous evidence into account the simplified electrical circuit across the β -cell membrane can be represented by the diagram of Fig. 4 (from Matthews, 1979), which, in contrast to the equivalent circuit for neuronal models, includes a major Ca^{2+} conductance component.

Within this framework it is therefore now possible to consider in more detail the ionic basis for the oscillatory electrical behaviour of the β -cell membrane under the influence of glucose.

It is known from recent studies that the metabolism of glucose leads to a decrease in membrane permeability to K^+ (Sehlin & Täljedal, 1975; Henquin, 1978; Boschero *et al.* 1977), and cyclic changes in membrane resistance have been observed to accompany the oscillations in membrane potential at a glucose concentration of 11.1 mM (Atwater *et al.* 1978).

Since the membrane potential is K-dependent the ability of glucose to reduce K-permeability and conductance would be sufficient to depolarize the cell below the threshold necessary for activation of regenerative Ca^{2+} entry. The biochemical studies also indicate that the K^+ permeability decreases most markedly at concentrations of D-glucose just below the threshold for inducing insulin release and electrical activity (see Henquin, 1978), thus providing a sensitive mechanism for controlling Ca^{2+} (or Ca^{2+}/Na^+) entry. It is also likely that in β -cells, as in many other cells (see Meech, 1978), the influx of Ca^{2+} , by raising the submembrane Ca^{2+} , acts in a negative-feedback fashion to increase membrane K^+ permeability (Matthews, 1975; Atwater & Beigelman, 1976). This would produce a degree of repolarization to oppose the effect of a glucose-induced decrease in P_K and so limit further Ca^{2+} influx (see Fig. 3). Additionally, the fast repolarization phase of the voltage-dependent spikes may be due not only to spontaneous inactivation of Ca^{2+} entry but also to the activation of a *rapid* voltage-dependent K^+ efflux (this latter mechanism although found so far in most excitable cells* has not yet been established experimentally in the β -cell membrane). It should also be pointed out at this stage that a further important distinction exists between the action potentials of neuronal membranes and the spike potentials of β -cells, not only with respect to amplitude but also duration, i.e. ≥ 1 ms for neurones (see Hodgkin, 1964) and *ca.* 50 ms for β -cells (Dean & Matthews, 1970*a, b*; Meissner & Schmeltz, 1974). The time course of the β -cell spikes thus resemble more closely the action potentials seen in smooth muscle and the heart (as described by Connors and by Brown

* It should, however, be noted that in some cells (see Brehm & Eckert, 1978) Ca^{2+} entry leads directly to an inactivation of Ca^{2+} channels which precedes and is independent of any delayed outward K^+ current.

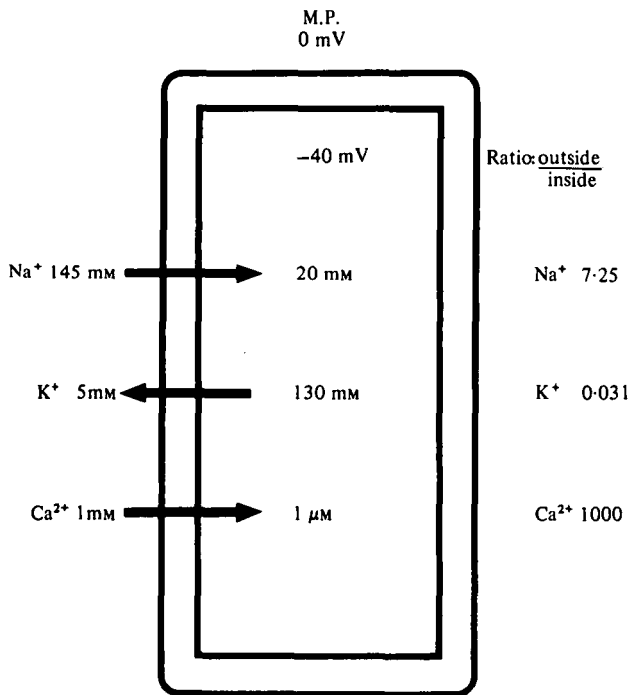

Fig. 5. Relative extracellular and intracellular (estimated) concentrations of Na⁺, K⁺ and Ca²⁺ in pancreatic β -cells. From Matthews (1979).

et al., in this volume). Finally, the regular repolarization phase at the end of each burst of electrical activity seen with relatively low concentrations of glucose, e.g. 11.1 mM (Fig. 2) could be accounted for not only by the slow but progressive change in P_K outlined above but also to the activation of an electrogenic Na pump (Matthews & Sakamoto, 1975*b*; Atwater & Meissner, 1975). At high concentrations of extracellular glucose, e.g. 28 mM; Fig. 1, the decrease of P_K may be so great as to suppress the effect of factors tending to increase K-permeability or activate an electrogenic Na pump. Spike activity then becomes continuous with the cell depolarizing to a level below which no spontaneous or regular slow repolarization phase can occur. Fig. 4 may be readily modified to accommodate these various additional mechanisms but such a diagram conveys little kinetic information. We therefore proceed in the final section of this paper to explore a more dynamic model of β -cell membrane function, although in the absence of voltage clamp studies, which are rendered technically difficult by the very small size of the β -cell, i.e. about 12 μ m diameter (Dean, 1973) and the existence of intercellular coupling (Meissner, 1976*b*), the precision and certainty of the model is necessarily limited to deductions made in accordance with the experimental evidence described above.

PANCREATIC ISLET CELLS: A MODEL OF GLUCOSE-INDUCED ELECTRICAL ACTIVITY

The electrical properties of the β -cell membrane are assumed for simplicity to reside in a voltage determined by the distribution of ions indicated in Fig. 5 and the limiting ionic conductivities already described (Fig. 4). Whilst these features might be consistent

with membrane activity conforming to Hodgkin-Huxley kinetic behaviour, the experimental evidence has demonstrated that the ion transfer processes differ from the simple Hodgkin-Huxley oscillator not only in that Ca^{2+} appears to be the major ion carrying inward current but also in the extended time course of the individual spikes and their frequency modulation by slow changes in basal membrane potential induced by glucose. These observations have led us to conclude that in the β -cell net current flow is never far from the Goldman equilibrium potential. The Goldman equation we have used is therefore a modification of the basic Hodgkin-Huxley form:

$$I = \sum_i \Delta V_i g_i, \quad (1)$$

where I is the current, $\Delta V_i = V_m - V_i$ (the difference in potential from the Nernst potential) and g_i is the ionic conductivity.

It should be pointed out here that our adoption of the Goldman equation is equivalent to the assumption that for a given instantaneous set of ionic concentrations and membrane permeabilities the electrical potential and ionic currents have reached their equilibrium value. That is, once a permeability change occurs a finite time is required for the ionic currents to reach their new equilibrium values appropriate to the new ionic permeabilities and the instantaneous ionic concentrations. Since the Goldman equation gives an essentially correct value even for the fast spike in the action potential of the nerve axon their equilibration time appears to be less than 1 ms and there is no reason at this stage to assume it to be different for the β -cell. Hence for the 50 ms 'spikes' of the β -cell we would expect that the rate-limiting processes controlling the membrane potential will be the rate of change of the ionic permeabilities. The Goldman equation should therefore provide a satisfactory description of the relationship between the β -cell membrane potential and the corresponding membrane ionic permeabilities during electrical spikes. In the case of the monovalent cations K^+ and Na^+ the Goldman equation takes the simple form

$$V_m = \frac{RT}{F} \ln \left(\frac{P_{\text{K}}[\text{K}^+]_o + P_{\text{Na}}[\text{Na}^+]_o}{P_{\text{K}}[\text{K}^+]_i + P_{\text{Na}}[\text{Na}^+]_i} \right),$$

but when divalent cations are included the equation becomes more complex. The more extended form of the equation incorporating P_{Ca} was derived originally by Spangler (1972) and again by Pickard (1976). Consequently we have used this extended form of the Goldman equation exclusively throughout our model (see equations (2)–(6) below) together with appropriate differential equations which represent the behaviour of membrane permeabilities. In this way we illustrate how the electrical patterns of β -cell activity may be produced in response to glucose. All differential equations controlling membrane ionic permeabilities are first order. No attempt is made to attribute higher-order behaviour to any permeability change process and thus no real oscillations are simulated; rather, we simply describe processes which could cause the observed inflexions to occur and follow the approximately first-order behaviour between inflexion points, using a digital computer (IBM 370; University of Cambridge) for a dynamic realization of the model.

The assumptions, definitions and equations on which the model is based will now be described in detail, followed by an appraisal of the dynamic operational features of the model which govern the β -cell membrane response to different concentrations of glucose.

(a) *Assumptions*

(1) The β -cell membrane potential difference, V_m , is determined by the individual ionic conductivities and Nernst potentials as described in equation (1).

(2) The extended Goldman equation is valid (defined in equations (2)–(6)).

(3) $[\text{Na}^+]_i$ and P_{Na} are constant.

(4) There are three independent potassium permeabilities: $\text{Bl}(G, t)$, $\text{Th}(G, V_m, t)$ and $K_{\text{K}}(V_m, \text{Th}, t)$.

(a) $\text{Bl}(G, t)$ determines the baseline potential.

(b) $\text{Th}(G, V_m, t)$ determines the slowly changing component of the potential in the silent and active phases; it therefore governs the silent phase duration and the start of the active phase.

(c) $K_{\text{K}}(V_m, \text{Th}, t)$ determines the V_m difference between the silent and the active phase.

(5) ‘Spike’ or ‘action’ potentials are due primarily to increases in P_{Ca} .

(6) $[\text{Ca}^{2+}]_i$ kinetics are fast enough to reach an approximately steady state in relation to all other processes in this model.

(7) Increases in Ca permeability are triggered by a voltage threshold, provided that $[\text{Ca}^{2+}]_i$ is below its threshold value.

(8) Calcium permeability decreases when $[\text{Ca}^{2+}]_i$ exceeds an upper threshold value, and cannot increase again until $[\text{Ca}^{2+}]_i$ decreases beyond a lower threshold value.

(9) Transient increases in submembrane $[\text{Ca}^{2+}]_i$ cause a partial saturation of local binding sites (treated in this model, for convenience, as kinetically equivalent to an increase in the rate of loss of $[\text{Ca}^{2+}]_i$ from the binding compartment, see equations (20)–(22)).

(10) Termination of an active phase occurs when the membrane potential difference falls below a given threshold value.

(b) *Kinetic rate constants*

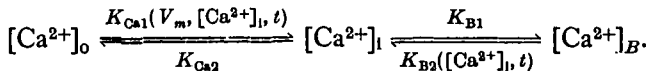
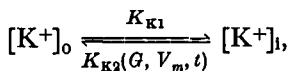
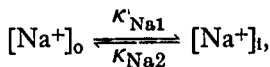

(c) *Definitions*

V_m	Beta cell membrane potential (mV).
R	Gas constant; $8.317 \text{ J}/^\circ\text{K}/\text{mole}$.
F	Faraday constant; $96.50 \text{ J}/\text{mV}/\text{mole}$.
T	Temperature; $310 \text{ }^\circ\text{K}$.
P_{Na}	Sodium permeability ($\mu\text{m}^{-2} \text{ s}^{-1}$).
P_{K}	Potassium permeability ($\mu\text{m}^{-2} \text{ s}^{-1}$).
$[\text{Na}^+]_o$	Sodium concentration outside the cell (mM).
$[\text{Na}^+]_i$	Sodium concentration inside the cell (mM).

- K_{Na1} $2.70 \times 10^{-4} \text{ s}^{-1}$, constant determining the passive rate of flow of sodium into the cell.
- K_{Na2} $1.96 \times 10^{-3} \text{ s}^{-1}$, constant determining the combined passive and active rate of flow of sodium out of the cell.
- $[K^+]_o$ Potassium concentration outside the cell (mM).
- $[K^+]_i$ Potassium concentration inside the cell (mM).
- K_{K1} 0.086 s^{-1} , constant determining the combined active and passive rate of flow of potassium into the cell.
- $K_{K2}(G, V_m, t)$ Parameter determining the passive rate of flow of potassium out of the cell (s^{-1}).
- $[Ca^{2+}]_o$ Free calcium concentration outside the cell (mM).
- $[Ca^{2+}]_i$ Free local steady state calcium concentration just inside the cell membrane (mM).
- $[Ca^{2+}]_B$ Bound local calcium concentration just inside the cell membrane (mM).
- $K_{Ca1}(V_m, [Ca^{2+}]_i, t)$ Parameter determining the passive rate of flow of calcium into the cell (s^{-1}).
- K_{Ca2} 2.0 s^{-1} , constant determining the combined passive and active flow of calcium out of the cell.
- K_{B1} 2.0 s^{-1} , constant determining the rate of flow of local submembrane calcium from the free to the bound state.
- $K_{B2}([Ca^{2+}]_i, t)$ Parameter determining the rate of flow of local submembrane calcium from the bound to the free state (s^{-1}).
- G Glucose concentration (mM).
- $K_K(V_m, Th, t)$ Parameter which determines the relative quiet and active phase potassium permeabilities in response to changes in $S_1(V_m, Th)$ (s^{-1}).
- $K_K(\infty)$ $1.50 \times 10^{-3} \text{ s}^{-1}$, a constant which determines the amount of change between the rate of passive potassium flow for the silent and the active phase.
- $S_1(V_m, Th)$ Parameter which determines whether the cell is in silent or active phase (no units).
- V_{Thres} -35.0 mV , constant determining the voltage threshold for the end of the active phase plateau; also triggers the setting of the steady state value for $Th(G, V_m, t)$.
- Th_T $2.80 \times 10^{-4} \text{ s}^{-1}$, constant which determines the threshold value for $Th(G, V_m, t)$ and hence the beginning of the active phase plateau.
- K_{RK} 16.0 s^{-1} , constant which determines the rate of change of $K_K(G, V_m, t)$.
- $Th(G, V_m, t)$ Parameter which determines the amount of slow change in the rate of passive potassium flow in either silent or active phase (s^{-1}). (Increases passive potassium flow rate during the active phase and decreases potassium flow rate in the silent phase.)
- $Th_-(\infty)$ $2.0 \times 10^{-4} \text{ s}^{-1}$, constant which determines the steady-state value of $Th(G, V_m, t)$ when $S_2(G, V_m)$ is zero.
- $Th_+(\infty)$ $6.0 \times 10^{-4} \text{ s}^{-1}$, constant which determines the addition to the steady state value of $Th(G, V_m, t)$ when $S_2(G, V_m)$ is equal to 1.
- $S_2(G, V_m)$ Parameter which determines whether the steady-state value of $Th(G, V_m, t)$ is high or low (no units).

- G_{Thres} 5.6 mM, constant which determines the threshold value for glucose concentration which triggers the setting of the steady-state value for $\text{Th}(G, V_m, t)$. (This value is chosen to represent a cell of average threshold.)
- K_{Th} 0.4 s⁻¹, constant determining the rate of change of $\text{Th}(G, V_m, t)$.
- $\text{Bl}(G, t)$ Parameter which determines the base-line and silent phase rate of passive potassium flow out of the cell (s⁻¹).
- $\text{Bl}(G, \infty)$ Parameter which determines the steady-state value of the base-line and silent phase rate of passive potassium flow as a function of glucose concentration (s⁻¹). (See equation (15).)
- K_{B1} 16.0 s⁻¹, constant which determines the rate of change of $\text{Bl}(G, t)$.
- $K_{\text{Ca1-}}(\infty)$ 0.002 s⁻¹, constant determining the steady-state value for the base-line rate of passive calcium flow.
- $K_{\text{Ca1+}}(\infty)$ 0.018 s⁻¹, constant determining the steady state value for the increased rate of passive calcium flow associated with the spike potential.
- $S_3(V_m, [\text{Ca}^{2+}]_i)$ Parameter determining whether the steady-state value of $K_{\text{Ca1}}(V_m, [\text{Ca}^{2+}]_i, t)$ is high or low (no units).
- V'_{Thres} 0.2 mV, constant which determines the increment in voltage between the active phase fast spike threshold and the threshold for the end of the active phase plateau.
- $S_4([\text{Ca}^{2+}]_i)$ Parameter which determines whether the steady-state rate of flow of calcium into the cell is at the high or low value (no units).
- $\text{Ca}_{\text{Thres+}}$ 5.0 μM , constant which determines the upper threshold in $[\text{Ca}^{2+}]_i$ for the turnoff of fast spikes by setting $S_4([\text{Ca}^{2+}]_i) = 1.0$.
- $\text{Ca}_{\text{Thres-}}$ 1.3 μM , constant which determines the lower threshold in $[\text{Ca}^{2+}]_i$ for the turn on of fast spikes by the setting of $S_4([\text{Ca}^{2+}]_i) = 0$.
- K_{RCa} 100.0 s⁻¹, constant determining the rate of change of $K_{\text{Ca1}}(V_m, [\text{Ca}^{2+}]_i, t)$.
- $K_{\text{B2}}([\text{Ca}^{2+}]_i, \infty)$ Parameter which determines the passive rate of release of calcium from local submembrane binding sites (s⁻¹). (The value of this parameter is related to the rate of calcium binding, and it is intended to produce behaviour similar to that which would be observed in the case of partial saturation of local binding sites due to very high transient increases in the calcium concentration just inside the cell membrane.)
- K_{RB2} 0.8 s⁻¹, constant determining the rate of change of $K_{\text{B2}}([\text{Ca}^{2+}]_i, t)$.

Input: G , Glucose concentration.

Output: $V_m(t)$, membrane potential as a function of time.

Initial conditions: $[\text{Na}^+]_o = 145$ mM, $[\text{Na}^+]_i = 20$ mM, $[\text{K}^+]_o = 5$ mM, $[\text{K}^+]_i = 130$ mM, $[\text{Ca}^{2+}]_o = 1$ mM, $[\text{Ca}^{2+}]_i = 0.001$ mM, $[\text{Ca}^{2+}]_B = 1$ mM.

(d) Equations

$$V_m = \frac{RT}{F} \ln \frac{(S_1 - T_1) + \sqrt{[(S_1 + T_1)^2 + 16(T_1 S_2 + T_2 S_1 + 4T_2 S_2)]}}{2(T_1 + 4T_2)}, \quad (2)$$

$$S_1 = [\text{K}^+]_o + \frac{P_{\text{Na}}}{P_{\text{K}}} [\text{Na}^+]_o, \quad (3)$$

$$T_1 = [\text{K}^+]_i + \frac{P_{\text{Na}}}{P_{\text{K}}} [\text{Na}^+]_i, \quad (4)$$

$$S_2 = \frac{P_{Ca}}{P_K} [Ca^{2+}]_o, \quad (5)$$

$$T_2 = \frac{P_{Ca}}{P_K} [Ca^{2+}]_i, \quad (6)$$

$$\frac{d[Na^+]_i}{dt} = -K_{Na2}[Na^+]_i + K_{Na1}[Na^+]_o, \quad (7)$$

$$\frac{d[K^+]_i}{dt} = -K_{K2}(G, V_m, t)[K^+]_i + K_{K1}[K^+]_o, \quad (8)$$

$$K_{K2}(G, V_m, t) = K_K(V_m, Th, t) + Th(G, V_m, t) + Bl(G, t), \quad (9)$$

$$\frac{dK_K(V_m, Th, t)}{dt} = [S_1(V_m, Th, t)K_K(\infty) - K_K(V_m, Th, t)]K_{RK}, \quad (10)$$

$$S_1(V_m, Th, t) = \begin{cases} 1, & \text{if } V_m < V_{Thres} \text{ and } Th(G, V_m, t) \geq Th_T, \\ 0, & \text{if } Th(G, V_m, t) < Th_T, \end{cases} \quad (11)$$

$$\frac{dTh(G, V_m, t)}{dt} = [Th_-(\infty) + S_2(G, V_m)Th_+(\infty) - Th(t)]K_{Th}, \quad (12)$$

$$S_2(G, V_m) = \begin{cases} 1, & \text{if } G < G_{Thres} \text{ or } V_m > V_{Thres} \\ 0, & \text{otherwise} \end{cases} \quad (13)$$

$$\frac{dBl(G, t)}{dt} = [Bl(G, \infty) - Bl(G, t)]K_{Bl} \quad (14)$$

$$Bl(G, \infty) = [\arctan(3.58(2.8)) + \arctan(3.58(2.8 - G))] \times 3.86 \times 10^{-3} + 9.92 \times 10^{-4}, \quad (15)$$

$$[Ca^{2+}]_i = ([Ca^{2+}]_o K_{Ca1}(V_m, [Ca^{2+}]_i, t) + [Ca^{2+}]_B K_{B2}([Ca^{2+}]_i, t)) / (K_{Ca2} + K_{Bl}), \quad (16)$$

$$\frac{dK_{Ca1}(V_m, [Ca^{2+}]_i, t)}{dt} = [K_{Ca1-}(\infty) + S_3(V_m, S_4)K_{Ca1}(\infty) - K_{Ca1+}(V_m, [Ca^{2+}]_i, t)]K_{RCa}, \quad (17)$$

$$S_3(V_m, S_4) = \begin{cases} 1, & \text{if } V_m > V_{Thres} + V'_{Thres} \text{ and } S_4 = 0, \\ 0, & \text{otherwise,} \end{cases} \quad (18)$$

$$S_4([Ca^{2+}]_i) = \begin{cases} 1, & \text{if } [Ca^{2+}]_i > Ca_{Thres+}, \\ 0, & \text{if } [Ca^{2+}]_i < Ca_{Thres-}, \end{cases} \quad (19)$$

$$\frac{d[Ca^{2+}]_B}{dt} = -K_{B2}([Ca^{2+}]_i, t)[Ca^{2+}]_B + K_{Bl}[Ca^{2+}]_i, \quad (20)$$

$$\frac{dK_{B2}([Ca^{2+}]_i, t)}{dt} = (K_{B2}([Ca^{2+}]_i, \infty) - K_{B2}([Ca^{2+}]_i, t))K_{RB2}, \quad (21)$$

$$K_{B2}([Ca^{2+}]_i, \infty) = K_{Bl}[Ca^{2+}]_i, \quad (22)$$

$$P_{Na}/P_K = K_{Na1}/K_{K2}(G, V_m, t), \quad (23)$$

$$P_{Ca}/P_K = K_{Ca1}(V_m, [Ca^{2+}]_i, t)/K_{K2}(G, V_m, t), \quad (24)$$

(e) *Operational characteristics of the model*

The equations (2)–(24) as defined are included in a computer programme (FORTRAN IV). Initial conditions are set to equilibrium or steady state at glucose 5.6 mM. When the

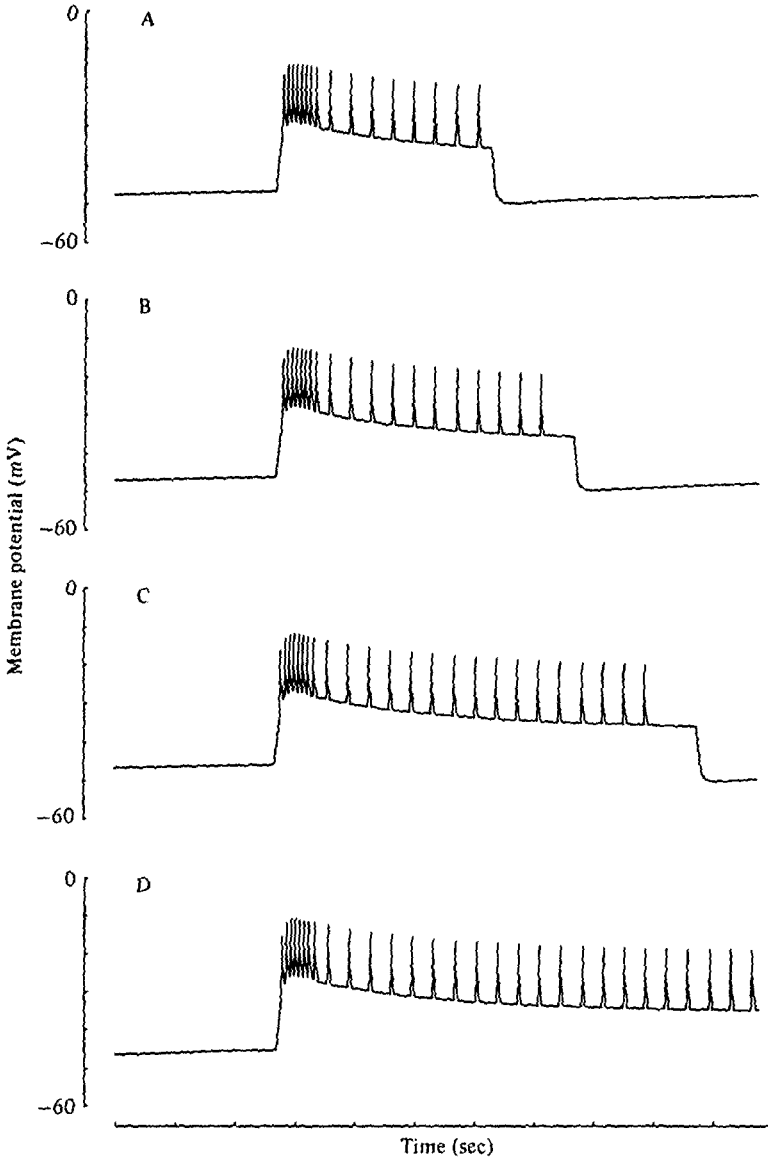

Fig. 6. Computer simulation of the electrical activity induced in a β -cell by D-glucose. Illustrated are the responses to increasing concentrations of D-glucose: (A) 8.4 mM; (B) 11.1 mM; (C) 16.6 mM; (D) 28 mM. These diagrams represent the lengthening of the plateau phase as the glucose concentration is increased. Note the maintained depolarization and electrical activity in (D). See text for further details.

glucose concentration is changed the behaviour of V_m adjusts to the new glucose concentration according to the Goldman equation and the differential equations as defined. For example, if the glucose concentration is increased sufficiently V_m will oscillate or if the concentration is decreased V_m will hyperpolarize to a new constant steady state level. The main feature of the model is a dynamic interaction between the ionic conductances and intracellular level of both calcium and potassium.

Although it is possible to systematically and independently vary the membrane Na permeability, in this model we have chosen for simplicity to maintain P_{Na} constant throughout (as indicated in assumption 3; equation (7) remains at a steady state); P_K therefore changes in response to glucose relative to a fixed P_{Na} (for initial conditions see page 85). Thus when the glucose concentration is increased there follows initially a very small gradual decrease in P_K (equations (12) and (13)); the P_K is then further reduced by a factor of approximately 3 (according to equations (9)–(11)), which causes the membrane potential to decrease rapidly (Fig. 6). As the membrane depolarizes the voltage threshold for the initiation of spikes is exceeded and fast spikes occur due to a rapid increase in P_{Ca} (controlled by equations (17)–(19)). When the local submembrane $[Ca^{2+}]_i$ reaches a certain limiting value (see equation (16)), P_{Ca} is reduced to its former silent phase value; subsequently, when the local $[Ca^{2+}]_i$ has decreased to a sufficiently low value, the P_{Ca} again increases rapidly (as defined by equations (16)–(19)).

Whilst the fast spikes are occurring there is a gradual *increase* in P_K (according to the same differential equation which alters P_K slowly during the silent phase, i.e. equations (12) and (13)). Eventually this slow increase in P_K reduces the membrane potential below the fast spike threshold level and the spikes cease. At a slightly lower threshold voltage the active phase ends (equations (9)–(11)), P_K increases dramatically to commence a silent phase, and the entire cycle of events begins again; a repetitive sequence is thereby established (see Fig. 7). These changes in P_K may well be Ca-dependent as outlined in the earlier section.

One other change which occurs during the active phase is that the local submembrane Ca^{2+} binding sites partially saturate (see assumption 9) and this lengthens the time interval for the local $[Ca^{2+}]_i$ to be lowered sufficiently to attain the fast spike trigger value. The interspike interval increases in consequence and fast spikes occur less frequently during the later part of the active phase (equations (16), (20)–(22)). Fig. 6 illustrates the effect on burst duration of increasing concentrations of glucose, from 8.4 to 28 mM. At the highest concentration (28 mM) the spike activity becomes continuous.

In the above description any electrical activity attributed exclusively to P_{Ca} could conceivably be due to a combined P_{Na} and P_{Ca} change. However, the experimental evidence described in the earlier part of this paper makes it necessary to specify a major role for P_{Ca} whereas the precise role of P_{Na} in the β -cell electrical pattern is not yet fully defined. Moreover, measurements of membrane resistance do not so far indicate a major role for P_{Na} on P_{Ca} changes in the silent phase or during the transition between active and silent phases (Atwater *et al.* 1977) although it is just possible that a slow change in P_{Na} or P_{Ca} could occur at these times but be obscured if the P_K increased reciprocally in compensation. In the silent to active phase transition the P_K decrease triggered by increasing glucose concentration may occur due to the action of glycolytic products either directly on the K^+ permeability or indirectly via an effect on Ca^{2+} binding sites. The indirect effect may, for example, involve a reduction in $[Ca^{2+}]_i$, which in turn reduces P_K . The model given here is based on a direct effect of glycolytic products but could be readily modified to operate by an indirect effect.

It is also possible, or even likely, that, in addition to any change in P_{Ca} , the turn-off of the fast spikes involves several distinct and rapid changes in P_K which would then fulfil a repolarizing role similar to that in other, excitable, cell membranes (Hodgkin

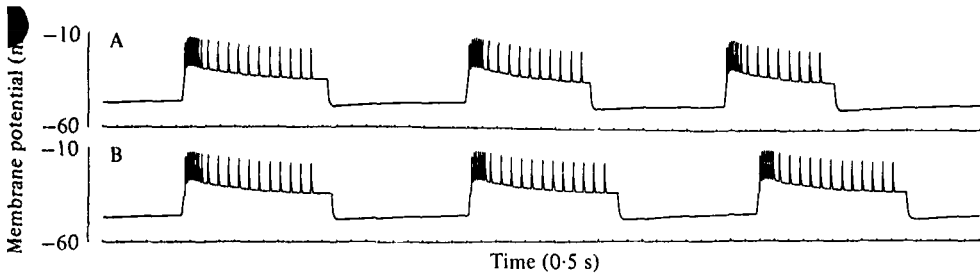

Fig. 7. Computer simulation of the bursts of electrical activity induced in a β -cell by continuous exposure to D-glucose 11.1 mM. In (A) the $[K^+]_i$ was allowed to fluctuate according to differential equation (8) of the model; in (B) the $[K^+]_i$ was held constant throughout. See text for further details.

1964; Thompson, 1977), but as already pointed out, little evidence is available at the present time concerning the dynamics of such processes.

Our model could be readily adapted to take these various features, as well as others (e.g. anionic changes), into account. In fact we have already demonstrated that the model remains valid in a dynamic range of $[Na^+]_i$ from 20 \rightarrow 50 mM and $[K^+]_i$ from 90 \rightarrow 175 mM and there is no reason why the necessary permeability constants involved cannot be further adjusted to span even wider ranges of ionic concentration.

The assumption that $[Ca^{2+}]_i$ declines more slowly with time during an active phase plateau is not inconsistent with several experimental observations. For example, increases in cytosolic Na^+ cause an increase in $[Ca^{2+}]_i$, in part by inhibiting the mitochondrial uptake of Ca^{2+} or by causing its actual release from mitochondria and other sequestration sites (see Lowe *et al.* 1976; Donatsch *et al.* 1977; Matthews, 1979); cyclic nucleotides may have similar effects (Sehlin, 1976), as may some glycolytic metabolites (Sugden & Ashcroft, 1977). Theoretical studies indicate that the $[Ca^{2+}]_i$ immediately beneath the cell membrane is likely to be in gradient form (see Matthews, 1979) and not strictly a steady state as assumed for simplicity in equation (16). Thus very high ionic Ca^{2+} transients near the cell membrane may well cause large increases in the amount of locally bound Ca^{2+} . This spatial heterogeneity and local saturation of binding sites will lead to a local submembrane accumulation of Ca^{2+} (reflected in equation (21) as equivalent to the increased passive release of $[Ca^{2+}]_B$; see assumption 9).

It is also of interest to note from the computer simulation of our model that for repeated bursts of electrical activity induced by glucose the gradual intracellular accumulation of K^+ , which is observed experimentally (Boschero *et al.* 1977), tends to hyperpolarize the cell and progressively shorten the duration of each succeeding burst of electrical activity (Fig. 7A). On the other hand, if $[K^+]_i$ is held constant (Fig. 7B) successive plateaus are then maintained at a relatively constant duration and voltage. Since repeated bursts of remarkably constant duration, voltage and periodicity are actually observed experimentally (see earlier sections), it is apparent that the β -cell must be able to counteract the effect of an increase in $[K^+]_i$, probably by a spontaneous adjustment of ionic permeabilities, e.g. $P_K \downarrow$, $P_{Na} \uparrow$, or by some other mechanism, e.g. a change in ionic pump activity. Linked to this effect on plateau duration and voltage is the fact that the threshold voltage sensitivity controlling the end of the plateau appears

hypersensitive in the model in its present form. This implies either that a process of accommodation indeed exists, such as that outlined above, or that some other mechanism, including glycolysis, must operate to terminate the plateau; more experimental evidence is needed on this point.

It is obvious from this discussion that the model we have described cannot be expected to offer a unique solution to the problems encountered in the interpretation of experimental data until that data is more complete. It does, however, illustrate and emphasize quantitatively the importance of several features of the experimental results we have described in detail in the previous sections. In summary, the features of the model which seem best supported by experimental evidence are:

- (a) A decrease in P_K with increasing glucose concentrations.
- (b) A P_K dominated membrane silent and plateau phase potential.
- (c) A decrease in P_K in transition from a silent to an active phase.
- (d) Initiation of 'fast' spikes by an increase in P_{Ca} .
- (e) A voltage-dependent threshold for the initiation and cessation of spike activity.
- (f) An increase in P_K in changing from an active to a silent phase.

Finally, it is clear from the viewpoint of this study that further experimental work is required to accurately pinpoint the following aspects of islet β -cell activity:

- (a) The basis of all permeability inflexion criteria.
- (b) The role of $[Na]_i$ and P_{Na} in governing membrane processes.
- (c) The role of homeostatic $[K^+]_i$ and V_m mechanisms.
- (d) The independence of the three types of P_K changes described here as well as the possible role of an additional rapid increase in P_K following each spike.
- (e) The role of electrogenic pumps and intercellular coupling in controlling electrical activity.
- (f) The detailed mechanism and kinetics of calcium binding at the inner aspect of the cell membrane and its relation both to insulin secretion and electrical activity.
- (g) The precise role of glucose metabolism in controlling these ionic processes.

For complete elucidation of these various processes sophisticated voltage-clamp techniques may be required – a difficult undertaking in electrically coupled cells of only 12 μ m diameter!

Work in the authors laboratory is supported by research grants from the British Diabetic Association, The Royal Society and the Medical Research Council; their aid is gratefully acknowledged.

REFERENCES

- ATWATER, I. & BEIGELMAN, P. M. (1976). Dynamic characteristics of electrical activity in pancreatic β -cells. I. Effects of calcium and magnesium removal. *J. Physiol., Paris* **72**, 769–786.
- ATWATER, I. & MEISSNER, H. P. (1975). Electrogenic sodium pump in β -cells of islets of Langerhans. *J. Physiol., Lond.* **247**, 56–58P.
- ATWATER, I., RIBALET, B. & ROJAS, E. (1978). Cyclic changes in potential and resistance in the β -cell membrane induced by glucose in islets of Langerhans from mouse. *J. Physiol., Lond.* **278**, 117–139.
- BEIGELMAN, P. M., RIBALET, B. & ATWATER, I. (1977). Electrical activity of mouse pancreatic β -cells. II. Effects of glucose and arginine. *J. Physiol., Paris* **73**, 201–217.
- BOSCHERO, A. C., KAWAZU, S., DUNCAN, G. & MALAISSE, W. J. (1977). Effect of glucose on K^+ handling by pancreatic islets. *FEBS Lett.* **83**, 151–157.
- BREHM, P. & ECKERT, R. (1978). Calcium entry leads to inactivation of calcium channel in *Paramecium*. *Science* **202**, 1203–1206.

- DEAN, P. M. (1973). Ultrastructural morphometry of the pancreatic β -cell. *Diabetologia* **9**, 111-114.
- DEAN, P. M. & MATTHEWS, E. K. (1968). Electrical activity in pancreatic islet cells. *Nature, Lond.* **219**, 389-390.
- DEAN, P. M. & MATTHEWS, E. K. (1970a). Glucose-induced electrical activity in pancreatic islet cells. *J. Physiol., Lond.* **210**, 255-264.
- DEAN, P. M. & MATTHEWS, E. K. (1970b). Electrical activity in pancreatic islet cells: effect of ions. *J. Physiol., Lond.* **210**, 265-275.
- DEAN, P. M., MATTHEWS, E. K. & SAKAMOTO, Y. (1975). Pancreatic islet cells: effects of monosaccharides, glycolytic intermediates and metabolic inhibitors on membrane potential and electrical activity. *J. Physiol., Lond.* **246**, 459-478.
- DONATSCH, P., LOWE, D. A., RICHARDSON, B. P. & TAYLOR, P. (1977). The functional significance of sodium channels in pancreatic beta-cell membranes. *J. Physiol., Lond.* **267**, 357-376.
- HENQUIN, J. C. (1978). D-Glucose inhibits potassium efflux from pancreatic islet cells. *Nature, Lond.* **271**, 271-273.
- HODGKIN, A. L. (1964). *The Conduction of the Nervous Impulse*. Liverpool University Press.
- LOWE, D. A., RICHARDSON, B. P., TAYLOR, P. & DONATSCH, P. (1976). Increasing intracellular sodium triggers calcium release from bound pools. *Nature, Lond.* **260**, 337-338.
- MATTHEWS, E. K. (1975). Calcium and stimulus-secretion coupling in pancreatic islet cells. In *Calcium Transport in Contraction and Secretion* (ed. E. Carafoli, F. Clementi, W. Drabikowski and A. Margreth), pp. 203-210. Amsterdam: North Holland.
- MATTHEWS, E. K. (1977). Insulin secretion. In *First European Symposium on Hormones and Cell Regulation* (ed. J. Dumont and J. Nunez), pp. 57-76. Amsterdam: North Holland.
- MATTHEWS, E. K. (1979). Calcium translocation and control mechanisms for endocrine secretion. In *Secretory Mechanisms* (ed. C. J. Duncan and C. Hopkins). *Symp. Soc. exp. Biol.*, no. 33. Cambridge University Press. (In the Press.)
- MATTHEWS, E. K. & DEAN, P. M. (1970). Electrical activity in islet cells. In *The Structure and Metabolism of the Pancreatic Islets* (ed. S. Falkmer, B. Hellman and I.-B. Täljedal), pp. 305-313. Oxford: Pergamon Press.
- MATTHEWS, E. K., DEAN, P. M. & SAKAMOTO, Y. (1973). Biophysical effects of sulphonylureas on islet cells. *Pharmacology and the Future of Man. Proc. 5th Int. Congr. Pharmac.*, San Francisco, 1972, vol. 3, pp. 221-229. Basel: Karger.
- MATTHEWS, E. K. & SAKAMOTO, Y. (1975a). Electrical characteristics of pancreatic islet cells. *J. Physiol., Lond.* **246**, 421-437.
- MATTHEWS, E. K. & SAKAMOTO, Y. (1975b). Pancreatic islet cells: electrogenic and electro-diffusional control of membrane potential. *J. Physiol., Lond.* **246**, 439-457.
- MEECH, R. W. (1978). Calcium-dependent potassium activation in nervous tissues. *Ann. Rev. Biophys. Bioeng.* **7**, 1-18.
- MEISSNER, H. P. (1976a). Electrical characteristics of the beta-cells in pancreatic islets. *J. Physiol., Paris* **72**, 757-767.
- MEISSNER, H. P. (1976b). Electrophysiological evidence for coupling between β cells of pancreatic islets. *Nature, Lond.* **262**, 502-504.
- MEISSNER, H. P. & ATWATER, I. (1976). The kinetics of electrical activity of β -cells in response to a 'square wave' stimulation with glucose or glibenclamide. *Hormone. Metab. Res.* **8**, 11-15.
- MEISSNER, H. P. & SCHMELZ, H. (1974). Membrane potential of β -cells in pancreatic islets. *Pflügers Arch.* **357**, 195-206.
- PACE, C. S. & PRICE, S. (1972). Electrical responses of pancreatic islet cells to secretory stimuli. *Biochem. biophys. Res. Commun.* **46**, 1557-1563.
- PACE, C. S. & PRICE, S. (1974). Bioelectrical effects of hexoses on pancreatic islet cells. *Endocrinology* **94**, 142-147.
- PICKARD, W. F. (1976). Generalizations of the Goldman-Hodgkin-Katz equation. *Math. Biosci.* **30**, 99-111.
- SEHLIN, J. & TÄLJEDAL, I.-B. (1975). Glucose-induced decrease in Rb^+ permeability in pancreatic β -cells. *Nature, Lond.* **253**, 635-636.
- SEHLIN, J. (1976). Calcium uptake by subcellular fractions of pancreatic islets: Effects of nucleotides and theophylline. *Biochem. J.* **156**, 63-69.
- SPANGLER, S. G. (1972). Expansion of the constant field equation to include both divalent and monovalent ions. *Ala. J. Med. Sc.* **9**, 218-223.
- SUGDEN, M. C. & ASHCROFT, S. J. H. (1977). Phosphoenolpyruvate in rat pancreatic islets: a possible intracellular trigger of insulin release. *Diabetologia* **13**, 481-486.
- THOMPSON, S. H. (1977). Three pharmacologically distinct potassium channels in molluscan neurones. *J. Physiol., Lond.* **265**, 465-488.