

# THE ROLES OF ENDOGENOUS MEMBRANE PROPERTIES AND SYNAPTIC INTERACTION IN GENERATING THE HEARTBEAT RHYTHM OF THE LEECH, *HIRUDO MEDICINALIS*

By RONALD L. CALABRESE\*

*Department of Biology, University of California, San Diego, La Jolla,  
California 92093*

(Received 4 September 1978)

## SUMMARY

1. Inhibitory synapses among the central neurones involved in the generation of the heartbeat rhythm of the leech were blocked by either low  $\text{Cl}^-$  physiological saline or presynaptic hyperpolarizing current.

2. Low  $\text{Cl}^-$  saline reversibly blocked inhibitory postsynaptic potentials (IPSPs) from the HN cells onto both other HN cells and HE cells but did not block electrical coupling among HN cells.

3. The rhythmic bursts of impulses in HE cells were abolished when IPSPs were blocked by either low  $\text{Cl}^-$  saline or hyperpolarization of HN cells.

4. The rhythmic bursts of impulses in HN cells were not abolished (except in cell HN(5)) when IPSPs were blocked by low  $\text{Cl}^-$  saline, but phase relations became unfixed (unless the cells were electrically coupled).

5. Both brief depolarizing and hyperpolarizing current pulses reset the rhythm of HN cells whose IPSPs were blocked by low  $\text{Cl}^-$  saline.

6. The results indicate that the motor neurones to the heart (HE cells) produce rhythmic impulse bursts because their steady discharge is periodically inhibited by the HN interneurons. The pattern generated by the HN cells originates from an endogenous rhythm co-ordinated by the inhibitory interactions and electrical coupling between these cells.

## INTRODUCTION

The constriction-dilation rhythm of a bilateral pair of longitudinal vessels that run the length of the animal, the 'heart tubes', pumps blood through the circulatory system of the leech *Hirudo medicinalis* (Mann, 1962). A set of rhythmically active heart motor neurones, the HE cells, control the constriction cycle of each segmental heart tube section. A bilateral pair of HE cell bodies is located on the ventral surface of each of the segmental ganglia 3-19 of the ventral nerve cord (cells HE(3)-HE(19), respectively) and each HE cell innervates the circular muscles (Hammersen & Staudte, 1969) of its ipsilateral segmental heart tube section via excitatory synapses (Thompson

\* Present address to which all communications should be sent: The Biological Laboratories, Harvard University, 16 Divinity Avenue, Cambridge, Massachusetts 02138.

& Stent, 1976a). The HE cell activity cycle consists of an active phase during which it produces an impulse burst and an inactive phase during which it receives a burst of inhibitory postsynaptic potentials or IPSPs (Thompson & Stent, 1976a).

A set of rhythmically active heart interneurons, the HN cells, control the activity of the HE cells via direct inhibitory synapses. A bilateral pair of HN cell bodies are located on the ventral surface of segmental ganglia 1-7. The HN cell activity cycle consists of an active phase during which they produce an impulse burst and an inactive phase during which they receive a burst of IPSPs. The HN cells make synaptic contacts with HE cells and/or HN cells in their own ganglion and/or project an axon rearward in the interganglionic connectives to synaptically contact more posterior HE cells and/or HN cells (Thompson & Stent, 1976b, c; Calabrese, 1977). All the IPSPs in the HE cells can be accounted for by the impulse activity of the four pairs of HN cells in segmental ganglia 3, 4, 6 and 7 (cells HN(3), HN(4), HN(6) and HN(7), respectively) except for a class of IPSPs common to cells HE(3)-HE(6) which has been attributed to an unidentified pair of HN cells, designated cells HN(X) (Thompson & Stent, 1976b). The manner in which the HN cells are connected to the HE cells (which is strictly ipsilateral) is shown in the hemilateral circuit diagram of Fig. 1A.

The heart interneurone ensemble comprises a network of neurones whose synaptic interaction results in a co-ordinated pattern of activity (Thompson & Stent, 1976b; Calabrese, 1977). The manner in which the identified HN cells are synaptically interconnected is shown in Fig. 1B (Thompson & Stent, 1976c; Calabrese, 1977). In addition to the inhibitory connexions shown in Fig. 1B some HN cells interact via rectifying electrical junctions. Such junctions have been identified between cell HN(X) and ipsilateral cells HN(3) and HN(4), cell HN(3) and ipsilateral cells HN(4), HN(6) and HN(7) and between cell HN(4) and ipsilateral cells HN(6) and HN(7) (Thompson & Stent, 1976c; Calabrese, 1977).

The complete heartbeat activity rhythm of both the HE cell and HN cell ensemble occurs incessantly in the totally isolated nerve cord (Thompson & Stent, 1976a, b, c; Calabrese, 1977), thus demonstrating that the rhythm is solely of central origin. In the present investigation, low  $\text{Cl}^-$  physiological saline or presynaptic hyperpolarizing current was used to block inhibitory synapses to determine whether the rhythm resulted from synaptic interactions among the HN and HE cells, or whether certain of the cells possessed an endogenous rhythm. It should be noted that  $\text{Cl}^-$  free ( $\text{SO}_4^-$ ) sea water does not interfere with the endogenous (Alving, 1968) rhythm of cell R15 of *Aplysia* (Waziri, Frazier & Kandel, 1965).

#### MATERIALS AND METHODS

Specimens of *Hirudo medicinalis* were purchased from commercial suppliers and maintained before use in aquaria at 15 °C. All experiments were carried out on isolated nerve cord preparations consisting of the head brain and at least the first seven segmental ganglia. Maintenance of the preparations, intracellular recording and passage of current into the neurones was as described by Kristan, Stent & Ort (1974) and Thompson & Stent (1976a) except that all experiments were done at room temperature.

Normal physiological saline consisted of NaCl (115 mM), KCl (4 mM),  $\text{CaCl}_2$

(1.8 mM), glucose (10 mM), and tris maleate buffer (10 mM, pH 7.4) while low  $\text{Cl}^-$  physiological saline consisted of  $\text{Na}_2\text{SO}_4$  (58 mM),  $\text{K}_2\text{SO}_4$  (2 mM),  $\text{CaCl}_2$  (1.8 mM), glucose (10 mM), sucrose (76 mM), tris maleate buffer (10 mM, pH 7.4).

Within a given segmental ganglion HE and HN cells were identified by the position of their cell bodies, by their characteristic impulse burst pattern and by their synaptic connexions to other neurones of the heartbeat control system. Acceptable resting potentials for HE cells were 40–50 mV and for HN cells were 40–60 mV.

## RESULTS

### *Removal of HN cell mediated inhibition from HE cells by hyperpolarization of HN cells reveals an underlying tonic discharge*

Thompson & Stent (1976*b*) have shown that the efficacy of action potential mediated inhibition of HE cells by HN cells is directly proportional to the amount of HN cell depolarization. It is thus possible to block the inhibitory effect of the HN cells onto the HE cells by hyperpolarizing the HN cells even though the hyperpolarization does not block action potential activity.

It is not necessary to directly hyperpolarize all the HN cells that connect with a given HE cell in order to block all inhibition onto that HE cell; the block can be achieved indirectly by taking advantage of the rectifying electrical junctions between certain HN cells (Thompson & Stent, 1976*b*). Thus it is possible to remove all inhibitory input onto cell HE(4) – i.e. the input from ipsilateral cells HN(X) and HN(3) (Fig. 1A) – by hyperpolarization of ipsilateral cell HN(4). (Cells HN(X) and HN(3) form rectifying electrical junctions with ipsilateral cell HN(4) in the fourth segmental ganglion (Thompson & Stent, 1976*c*.) Such an experimental manipulation causes cell HE(4) to produce a tonic impulse train (Fig. 2). Such results indicate that the HE cells are rhythmically active because their tonic discharge is periodically interrupted by bursts of IPSPs from the HN cells.

### *IPSPs in the HN cell-HE cell ensemble are blocked by low external $\text{Cl}^-$ concentrations*

The observation that either iontophoretic injection of  $\text{Cl}^-$  or pressure injection of 200 mM-KCl (but not 200 mM-K acetate) into HE and HN cells reverses the polarity of IPSPs mediated by HN cells (Nicholls & Wallace, 1978) was confirmed. These results indicate that  $\text{Cl}^-$  carries the major current for these IPSPs, so removal of  $\text{Cl}^-$  from the saline bathing the nerve cord should reduce the amplitude of HN mediated IPSPs in the HE cells and HN cells.

When the nerve cord was washed in saline containing less than 5% of the normal concentration of  $\text{Cl}^-$  for 5 min or more, the HN cell mediated IPSPs were blocked or greatly reduced in amplitude both in HE cells (Fig. 3A) and in other HN cells (Fig. 3B) regardless of the level of polarization of the postsynaptic cell. Both HN and HE cells were depolarized by about 5 mV, as recorded in the cell body. The effects were reversible (Fig. 3C, D).

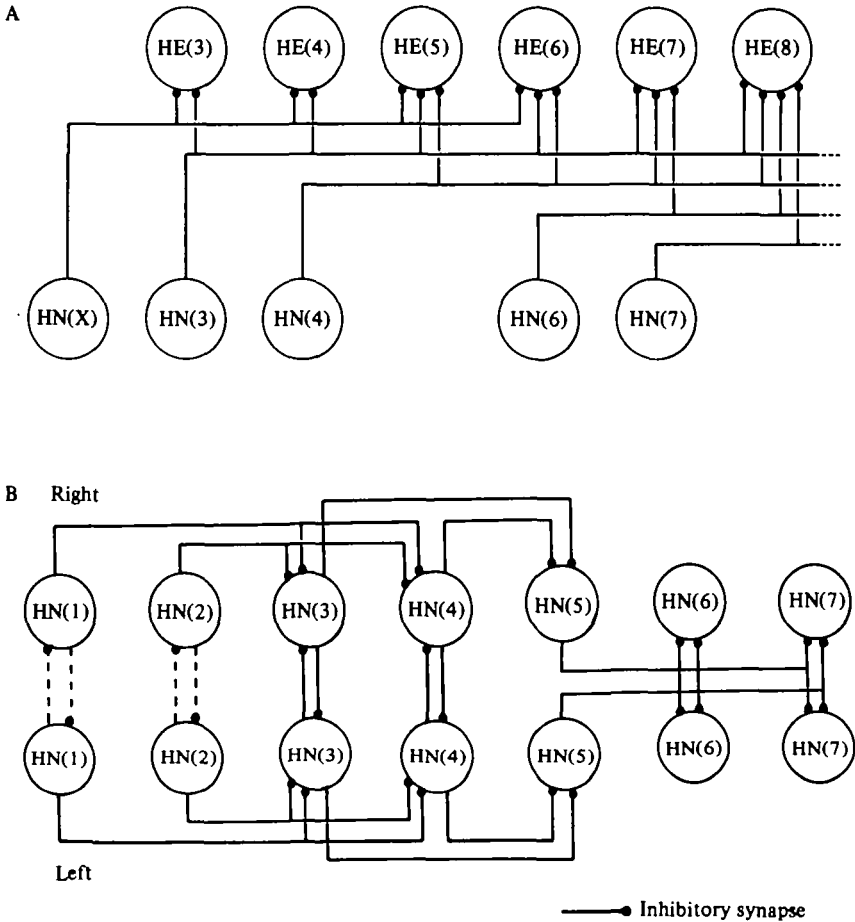

Fig. 1. HE cell and HN cell synaptic interactions. (A) Hemilateral circuit diagram showing synaptic connexions between HN and HE cells. Each labelled circle represents a particular nerve cell's primary impulse initiation site. The lines represent cell processes. Filled circles represent inhibitory synapses. Caudal to HE(8) all HE cells are contacted by ipsilateral cells HN(3), HN(4), HN(6), and HN(7). The circuit is duplicated on the other body side. Abstracted from Thompson & Stent (1976*b*). (B) Schematic circuit diagram showing the inhibitory synaptic connexions among heart interneurons. Each labelled circle represents a particular nerve cell's primary impulse initiation site, which is usually located in the same ganglion as the cell body. The lines represent cell processes. Dashed lines indicate connexions thought to exist on the basis of indirect evidence. Abstracted from Calabrese (1977).

*HN cell mediated electrical junctional potentials in other HN cells are not blocked in saline containing low  $Cl^-$  concentration*

The records of Fig. 4 show that HN cell mediated electrical junctional potentials (Thompson & Stent, 1976*c*) in other HN cells were not blocked by lowering external  $Cl^-$  to levels which completely block HN cell mediated IPSPs. It was also found that DC electrical coupling between other leech neurones (e.g. the Retzius cells and the Leydig cells) is unaffected by such low external  $Cl^-$  concentrations. Thus leech electrical synapses differ from the synapses between the lateral giant neurones of crayfish which are uncoupled by low  $Cl^-$  saline (Asada & Bennett, 1971).

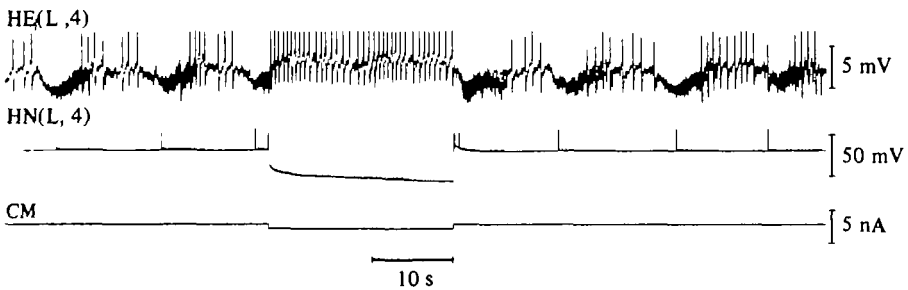

Fig. 2. Blockade of IPSPs from cell HN(L, 3) and HN(L, X) onto cell HE(L, 4) in the fourth segmental ganglion by hyperpolarization of their presynaptic terminals causes cell HE(L, 4) to produce a tonic impulse train. Hyperpolarization was effected by injecting a long hyperpolarizing pulse of current (CM) into cell HN(L, 4) (see text). Most of the impulses of the HN(L, 4) burst did not invade the cell body during this record (especially during cell HN(L, 4) hyperpolarization) but appear as attenuated depolarizing potentials. In this and other figures, L in the cell's name denotes the left-hand side of the body; R denotes the right.

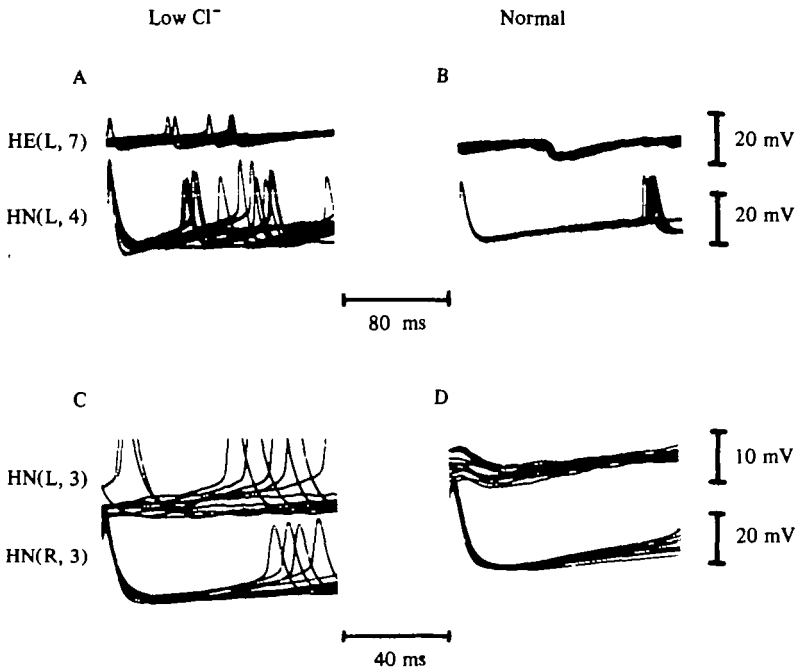

Fig. 3. Reversible blockage by low  $\text{Cl}^-$  saline of IPSPs from HN cells onto HE cells and onto other HN cells. In each panel 10 oscilloscope sweeps were triggered by action potentials recorded in an HN cell body (lower trace). (A) Cell HN(L, 4) makes an inhibitory synapse on cell HE(L, 7) but no IPSP is recorded in cell HE(L, 7) after impulses in cell HN(L, 4) in low  $\text{Cl}^-$  saline. (B) After return of chloride, an IPSP mediated by HN(L, 4) is apparent in HE(L, 7). (C) Cell HN(L, 3) makes an inhibitory synapse on cell HN(R, 3) but no IPSP is recorded in HN(R, 3) after impulses in HN(L, 3) in low  $\text{Cl}^-$  saline. (D) After return of chloride an IPSP mediated by HN(L, 3) is apparent in HN(R, 3).

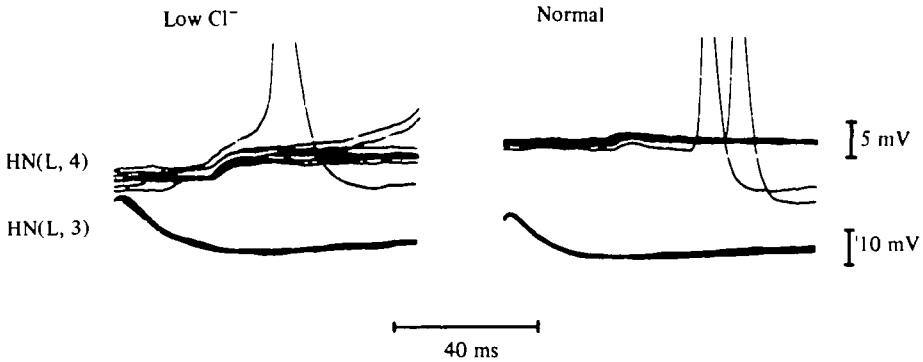

Fig. 4. Low  $\text{Cl}^-$  saline does not block electrical coupling among HN cells. In each record eight oscilloscope sweeps were triggered by an action potential recorded in the HN(L, 3) cell body (lower trace) while cell HN(L, 4) was monitored. In both low  $\text{Cl}^-$  (left) and after return of chloride (right), an electrical junctional potential mediated by HN(L, 3) is apparent in cell HN(L, 4).

*Most HN cells continue to produce rhythmic impulse bursts in the absence of inhibition from the other HN cells*

When chloride was lowered to levels which blocked all HN cell mediated IPSPs, inhibition within the HE cell and HN cell ensembles was also blocked. All HE cells tested produced tonic impulse trains as with hyperpolarization of HN cells (Fig. 2); all HN cells tested also showed no IPSPs but continued to produce rhythmic impulse bursts except cell HN(5). (Cells HE(9) to HE(19) and cell HN(X) have not been observed in low  $\text{Cl}^-$  and cell HN(5) will be discussed later.) Such results are shown for cells HE(7) and HN(4) in Fig. 5. These data confirm the earlier inference (Fig. 2) that the impulse burst rhythm of the heart motor neurones is not of endogenous origin but results from their steady discharge being periodically inhibited by the HN cells. They also show that the heart interneurons HN(1), HN(2), HN(3), HN(4), HN(6) and HN(7) generate impulse bursts endogenously.

A two- to sixfold decrease in impulse burst period of HN cells (except cell HN(5)) in low  $\text{Cl}^-$  saline as compared to normal saline was consistently observed (Figs. 5, 7, 8, 9) yet all solutions were maintained at the same temperature and only small changes (5 mV depolarization) in resting potential were noted. It seems that when HN cells are freed of inhibition they express an inherent impulse burst period which is shorter than that which can be expressed in the presence of inhibitory synaptic input.

*Brief injected current pulses can reset the impulse burst rhythms of an HN cell in the absence of inhibition from other HN cells*

If the HN cells are similar to other invertebrate neurones which produce impulse bursts endogenously, then their impulse burst rhythms should be reset by brief pulses of injected current (Strumwasser, 1967; Russell & Hartline, 1978). The records of Fig. 6 show that the HN(4) cell displayed this property when the inhibitory inputs onto it were blocked by bathing the preparation in low  $\text{Cl}^-$  saline. In the absence of injected current the HN(4) cell impulse burst period was nearly constant (Fig. 6B). When a brief depolarizing current pulse (300 ms, 0.4 nA) was injected into the HN(

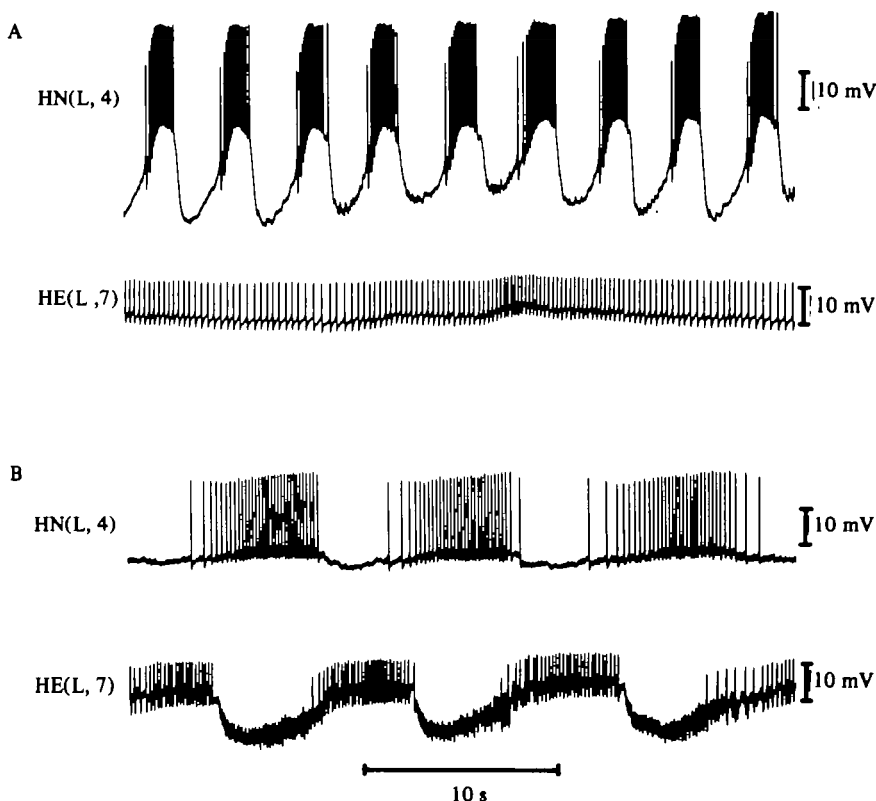

Fig. 5. Evidence that HN cells produce impulse bursts endogenously whereas HE cells produce impulse bursts only when they receive rhythmic inhibitory input from HN cells. (A) Upon blockade of IPSPs mediated by HN cells in cells HE(L, 7) and HN(L, 4) by bathing the preparation in low  $\text{Cl}^-$  saline, cell HN(L, 4) produces rhythmic impulse bursts while cell HE(L, 7), which is normally rhythmically inhibited by cell HN(L, 4), produces only a tonic impulse train. Electrical junctional potentials from cells HE(L, 3) and HN(L, X) are apparent in cell HN(L, 4). There are no IPSPs. (B) After return of chloride, IPSPs mediated by HN cells reappear in both cells HE(L, 7) and HN(L, 4), and cell HE(L, 7) becomes rhythmically active in antiphase with cell HN(L, 4) which continues its rhythmic activity.

cell through the recording microelectrode in between an impulse burst and the next expected impulse burst, a premature impulse burst was initiated which outlasted the current pulse, and the cell's impulse burst rhythm was reset (Fig. 6A, B). That is, the first HN(4) cell impulse burst after the induced burst occurred earlier than expected. When a brief hyperpolarizing current pulse (300 ms, 0.4 nA) was injected into the HN(4) cell through the recording microelectrode toward the end of an impulse burst, that impulse burst was prematurely terminated and the cell's impulse burst rhythm was reset (Fig. 6B, C). That is, the next HN(4) cell impulse burst was produced earlier than expected. Similar results were obtained with the HN(3) cell. Russell & Hartline (1978) have argued that such behaviour constitutes evidence that a nerve cell produces impulse bursts through endogenous membrane properties.

In normal saline brief injected current pulses have little or no effect on the HN cell impulse burst rhythm, presumably because any resetting effects of the current pulses are overridden by inhibitory synaptic input from other HN cells. Prolonged depolarizing

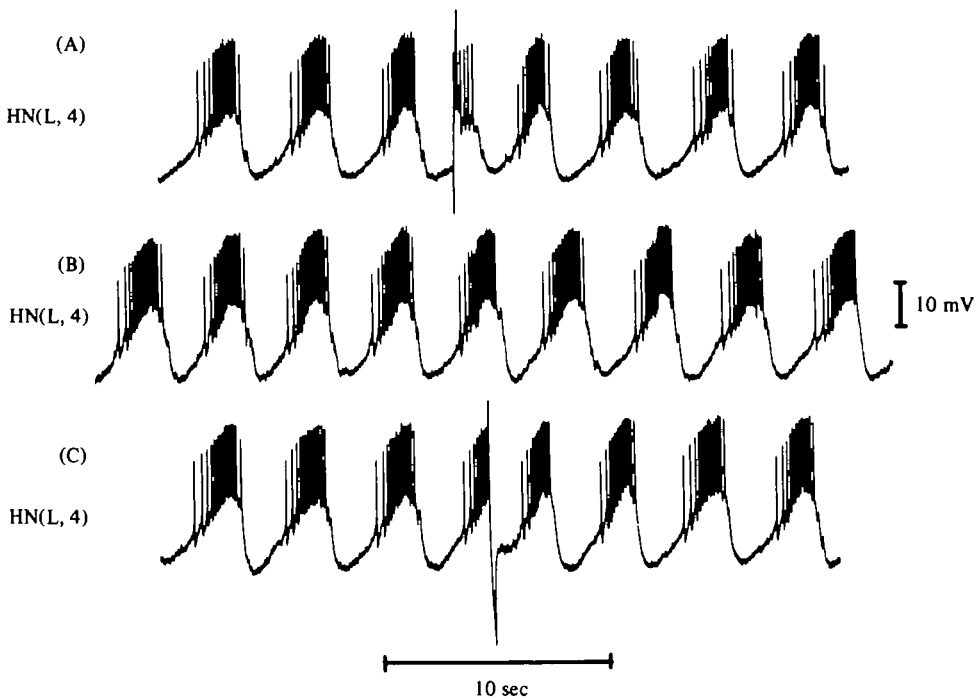

Fig. 6. Brief injected current pulses can reset the impulse burst rhythm of an HN cell after blockade of IPSPs from other HN cells. All records were taken from the same preparation while bathed in low  $\text{Cl}^-$  saline. All current pulses were injected through the recording micro-electrodes and were 300 ms in duration and 0.4 nA in amplitude. The first impulse burst of panels A and C are aligned with the second impulse burst of panel B to facilitate the observation of the resetting effect of current injection. (A) Injection of a depolarizing current pulse in between an HN(L, 4) cell impulse burst and the next expected impulse burst prematurely initiates an impulse burst which outlasts the current pulse and resets the HN(L, 4) cell impulse burst rhythm. (B) In the absence of injected current the HN(L, 4) cell impulse burst period is nearly constant. (C) Injection of a hyperpolarizing current pulse toward the end of an HN(L, 4) cell impulse burst prematurely terminates the impulse burst and resets the HN(L, 4) cell impulse burst rhythm.

current pulses which produce many impulses can however reset the HN cell impulse burst rhythm in normal saline (Thompson & Stent, 1976b).

*Inhibitory synaptic interactions among HN cells serve to coordinate their independent impulse burst rhythms into a functional pattern*

The results of Fig. 5 suggest that the role of the inhibitory synaptic input onto HN cells is to lock their endogenous impulse burst rhythms into an appropriate phase and period. More evidence for this last conclusion is presented in the records of Fig. 7. The two HN(3) cells which normally produce antiphasic impulse bursts due to reciprocal inhibitory connexions (Thompson & Stent, 1976c; Calabrese, 1977) (Fig. 1B) produced their impulse bursts with no fixed phasing in low  $\text{Cl}^-$  saline which blocked the IPSPs from one another and the other HN cells (Fig. 7A). Upon return of chloride the normal antiphasic impulse burst pattern reappeared but with an increased period (Fig. 7B). Moreover, these results could be repeated with the



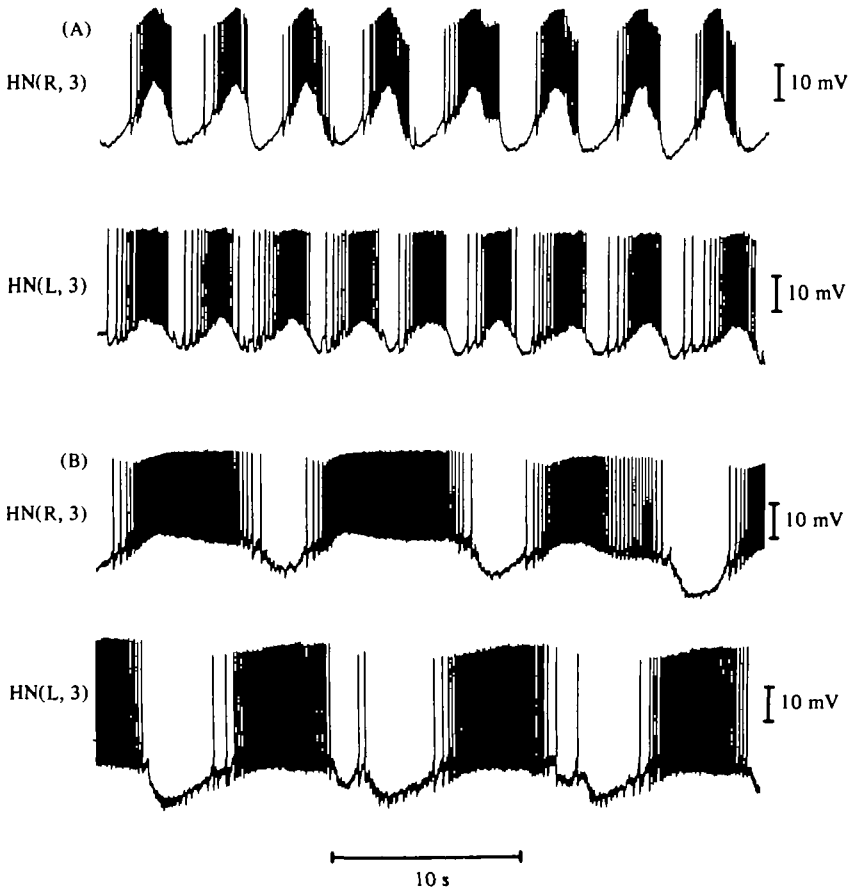

Fig. 7. Inhibitory synaptic interactions among HN cells serve to coordinate the independent impulse burst rhythms of these cells into a functional pattern. (A) Upon blockade of IPSPs mediated by HN cells in cells HN(R, 3) and HN(L, 3) by bathing the preparation in low  $\text{Cl}^-$ , these cells - which are normally active in strict antiphase with one another due to reciprocal inhibitory synaptic connexions - show no fixed phase relationship. (B) After return of chloride, IPSPs mediated by HN cells reappear in both HN(3) cells and the impulse burst rhythms of these cells resume their normal antiphase relationship.

reciprocally inhibitory HN(4) cell pair and with ipsilateral cells HN(2) and HN(3) where the inhibitory interaction is unidirectional (Thompson & Stent, 1976c; Calabrese, 1977) (Fig. 1B).

*Electrical coupling can synchronize the impulse burst rhythms of HN cells*

The members of the HN cell ensemble interact both via inhibitory synapses and electrical coupling (Thompson & Stent, 1976c; Calabrese, 1977). The low  $\text{Cl}^-$  results indicate that inhibitory synapses among HN cells serve to coordinate their independent HN cell impulse burst rhythms into a functional pattern. These experiments, however, have not assessed the role of electrical coupling in the co-ordination of the HN cell impulse burst rhythms. In contrast to the results presented earlier (Fig. 7)

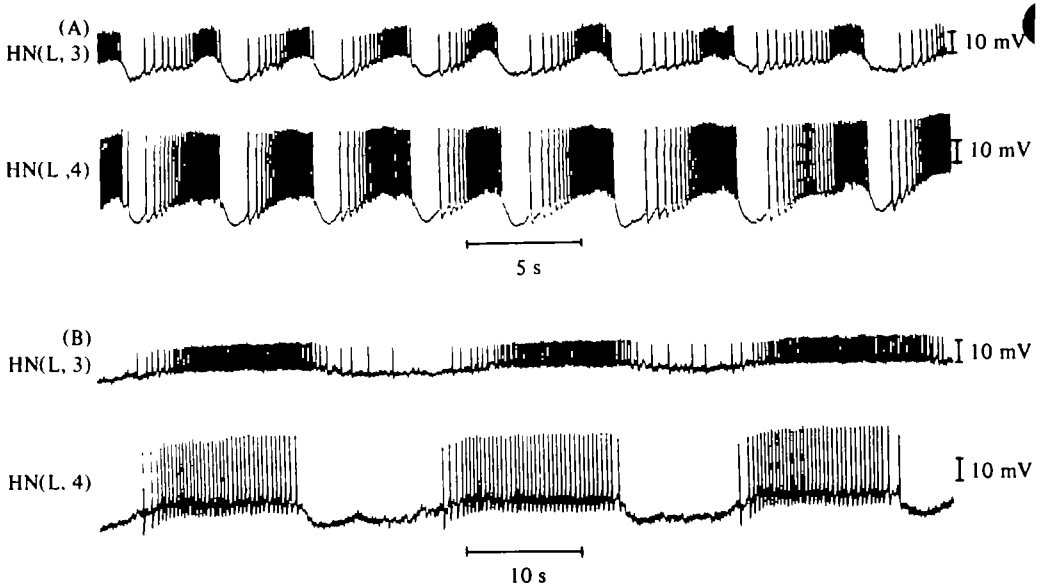

Fig. 8. Electrical coupling is sufficient to maintain a fixed phasing of the impulse burst rhythms of HN cells. (A) Inphase impulse burst rhythms recorded from cells HN(L, 3) and HN(L, 4) (electrically coupled in the fourth segmental ganglion) when IPSPs mediated by other HN cells are blocked by bathing the preparation in low Cl<sup>-</sup> saline. (B) Upon return of chloride, IPSPs reappear in both HN cells and they continue to produce inphase impulse burst rhythms.

which show that HN cells which interact via inhibitory synapses lose the fixed phasing of their activity rhythms in low Cl<sup>-</sup> (which blocks inhibitory interactions), the records of Fig. 8 show that HN cells which interact via electrical coupling display a fixed phasing of their activity rhythms in low Cl<sup>-</sup> (which does not block electrical coupling among HN cells). In low Cl<sup>-</sup>, cells HN(L, 3) and HN(L, 4) (which are electrically coupled in the fourth segmental ganglion: Thompson & Stent, 1976c) (Fig. 4) produced inphase impulse burst rhythms (Fig. 8A). Upon return of chloride, cells HN(L, 3) and HN(L, 4) continued to produce inphase impulse burst rhythms (Fig. 8B) but with a much longer period. Ipsilateral cells HN(4) and HN(7) (which are electrically coupled in the seventh segmental ganglion (Calabrese, 1977)) similarly produced inphase burst rhythms in low Cl<sup>-</sup>.

During the normal functioning of the HN cell ensemble ipsilateral cells HN(L, 3) and HN(L, 4) always produce inphase impulse burst rhythms (Thompson & Stent, 1976b; Calabrese, 1977) but it has not been clear to what extent the electrical coupling contributed to this co-ordination, since these cells receive identical inhibitory input, from ipsilateral cells HN(1) and HN(2) (Calabrese, 1977). The results presented above clearly indicate that the electrical coupling is sufficient to maintain a fixed phasing of the impulse burst rhythms of HN cells in the absence of inhibitory synaptic input. The importance of electrical coupling in the co-ordination of HN cell impulse burst rhythms should not be overemphasized however, since HN cells which receive inhibitory input in antiphase with electrical junctional potentials (e.g. cells HN(6) and HN(7) on the side of the inactive cell HN(5) (see below)) have their impulse burst rhythms phased by the inhibitory input (Thompson & Stent, 1976c; Calabrese

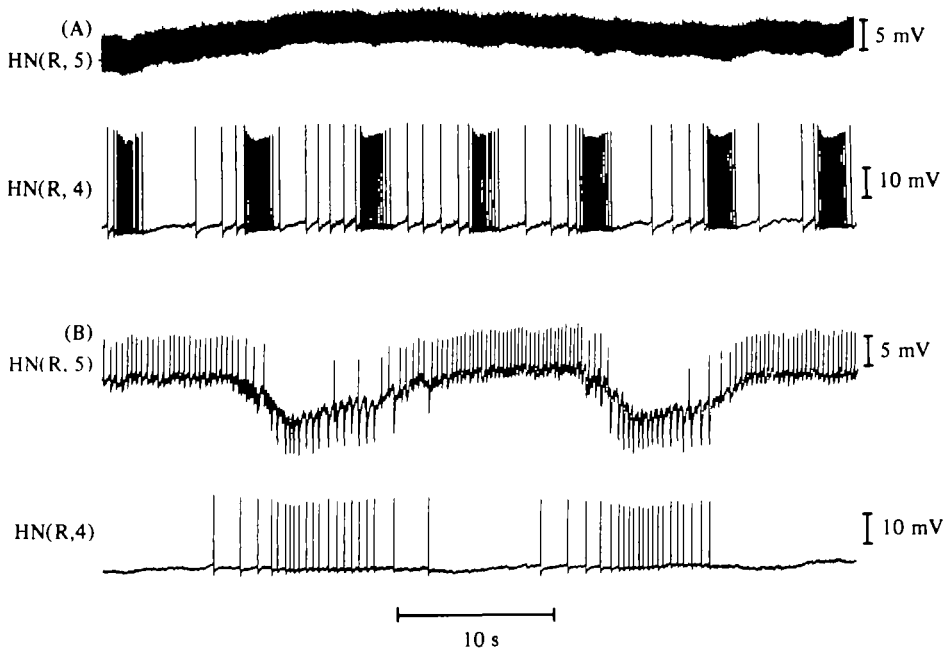

Fig. 9. Evidence that cell HN(5) does not produce impulse bursts endogenously but only in the presence of rhythmic inhibitory input from other HN cells. (A) Upon blockade of IPSPs mediated by HN cells in cells HN(R, 4) and HN(R, 5) by bathing the preparation in low  $\text{Cl}^-$  saline, cell HN(R, 4) produces rhythmic impulse bursts while cell HN(R, 5) which is normally rhythmically inhibited by cell HN(R, 4) produces only a tonic impulse train. (B) After return of chloride IPSPs mediated by HN cells reappear in both cell HN(R, 4) and HN(R, 5) and cell HN(R, 5) becomes rhythmically active in antiphase with cell HN(R, 4) which continues its rhythmic activity.

1977). Therefore, it appears that electrical coupling can only exert its co-ordinating effect on HN cell impulse bursts rhythms in the absence of competing inhibitory synaptic input.

*The HN(5) cells do not produce rhythmic impulse bursts in the absence of inhibition from other HN cells*

Unlike the other HN cells tested, cell HN(5) produces only a tonic impulse train or no impulse activity whatsoever when rhythmic HN cell inhibition is removed from it by bathing the nerve cord in low  $\text{Cl}^-$  saline. Fig. 9 shows records from such an experiment. In low  $\text{Cl}^-$  saline which blocked IPSPs in cell HN(R, 5) the cell produced a tonic impulse train while cell HN(R, 4) whose IPSPs were also blocked continued to produce rhythmic impulse bursts (Fig. 9A). Upon return of chloride, IPSPs reappeared in both cells. Cell HN(R, 5) took on its normal rhythmic activity of impulse bursts interrupted by bursts of IPSPs from cells HN(R, 3) and HN(R, 4) (Fig. 1C) and cell HN(R, 4) continued to produce rhythmic impulse bursts but now they were interspersed by IPSPs and had a longer period (Fig. 9B). These results indicate that the HN(5) cells, unlike the other HN cells, do not produce impulse bursts endogenously but must be rhythmically inhibited by the other HN cells to be

rhythmically active. This inability to produce impulse bursts endogenously may be related to the fact that only one HN(5) cell is rhythmically active at a time, the other being completely inactive (Calabrese, 1977).

#### DISCUSSION

##### *Low Cl<sup>-</sup> physiological saline reversibly blocks IPSPs in the HE and HN cell ensemble*

When the leech nerve cord was bathed in a physiological saline which contains less than 5% of the normal concentration of Cl<sup>-</sup>, IPSPs in the HE and HN cell ensemble were greatly reduced in amplitude or completely blocked with only a small concomitant change in the resting potentials of the cells. One might expect that if the IPSPs were Cl<sup>-</sup> mediated, then bathing the nerve cord in low Cl<sup>-</sup> saline would not block the IPSPs but rather convert them to depolarizing potentials. Reversal of the IPSPs was never observed in low Cl<sup>-</sup> saline at resting potential. In some cases where block was incomplete and small postsynaptic potentials were still discernible, they were always hyperpolarizing (e.g. Fig. 9). Furthermore, manipulation of the postsynaptic cell's membrane potential does not reveal a covert potential in low Cl<sup>-</sup>. A possible explanation of these findings is that HE and HN cells maintain a very low internal concentration of Cl<sup>-</sup> which is easily depleted by repeated synaptic activation while washing in low Cl<sup>-</sup> saline. Once the concentration of Cl<sup>-</sup> inside and outside an HE or HN cell has equilibrated only very small synaptic current can flow and membrane resistance changes induced by transmitter release will be negligible because no ions will be available to flow through open Cl<sup>-</sup> channels. This interpretation is consistent with the observation that IPSPs mediated by HN cells in both HE cells and HN cells are quickly reversed by pressure injection or iontophoresis of Cl<sup>-</sup> into the cells (personal observation; Nicholls & Wallace, 1978).

The possibilities that low Cl<sup>-</sup> acts by some presynaptic mechanism or by interfering with postsynaptic receptors cannot be ruled out. However, both these mechanisms seem unlikely. Regardless of the mechanism by which low Cl<sup>-</sup> physiological saline blocks IPSPs among HN and HE cells the records of Figs. 4 and 5 clearly demonstrate that such saline blocks inhibitory interactions among HN and HE cells. Therefore low Cl<sup>-</sup> saline can be used to study the effects of blocking inhibitory interactions in the HE and HN cell ensembles.

##### *The origin of the heartbeat rhythm*

The results presented in this paper indicate, upon first analysis, that the central motor pattern generator for heartbeat in the leech is not a network oscillator but an endogenous oscillator (Kristan *et al.* 1977). During blockade of the inhibitory synaptic interactions among the HN cells by bathing the preparation in low Cl<sup>-</sup> saline, the HN cells maintain their impulse burst rhythms (except for cell HN(5)) which can then be reset by brief hyperpolarizing and depolarizing current pulses. Therefore, it is highly likely that these cells produce impulse bursts by some endogenous property. On the other hand, the HE cells produce only tonic impulse trains when the inhibitory synaptic input from the HN cells onto the HE cells is blocked either by hyperpolarization of HN cells or by bathing the preparation in low Cl<sup>-</sup> saline. This tonic activity is probably inherent, since no EPSPs are recorded in the HE cells teste

here (Thompson & Stent, 1976*a, b, c*; Calabrese, 1977). Hence, the rhythmic activity of the HE cells results from their inherent steady discharge being periodically inhibited by IPSP bursts from the HN cells.

However, it is incorrect to conclude that the heartbeat rhythm results solely from endogenous activity of the HN cells. During blockade of inhibitory synaptic interaction among HN cells, their impulse burst rhythms are not co-ordinated into their normal precise pattern. Instead, the impulse burst rhythms of those HN cells which interact via inhibitory synapses no longer show any preferred phasing. Hence, the independent impulse burst rhythms of the HN cells must be co-ordinated by their inhibitory synaptic interactions into their functional pattern. Similarly, *Aplysia* and lobster neurones that produce impulse bursts endogenously can be co-ordinated by periodic inhibitory synaptic input (Pinsker, 1977*a, b*; Ayers & Selverston, 1978).

Electrical coupling also contributes to the co-ordination of the HN cell impulse burst rhythms. During blockade of inhibitory synaptic interactions among HN cells, electrically coupled cells produce their impulse burst rhythms in phase. However, the synchronizing effect of electrical coupling can be over-ridden by antiphasic inhibitory synaptic input (Thompson & Stent, 1976*c*; Calabrese, 1977) and is therefore only expressed in the absence of such competing inhibitory synaptic input in the normal functioning of the HN cell ensemble.

The endogenous activity of the HN cells hence produces the basic heartbeat rhythms, but the normal heartbeat motor pattern requires in addition the synaptic interaction among HN cells. Thus, the central pattern generator for heartbeat in the leech (the HN cell ensemble) is neither purely a network oscillator nor an endogenous oscillator but rather a member of the growing class of mixed oscillators (Kristan *et al.* 1977).

I would like to thank Dr William Kristan, Jr. for his help and encouragement, Dr Daniel K. Hartline for many helpful discussions and Dr Kristan for criticizing the manuscript.

This research was supported by NIH postdoctoral fellowship no. 1 F32 NS 05993-01, NSF grant no. GN 575-23567, and a postdoctoral fellowship from the Alfred P. Sloan Foundation.

#### REFERENCES

- ALVING, B. O. (1968). Spontaneous activity in isolated somata of *Aplysia* pacemaker neurons. *J. gen. Physiol.* **51**, 29-45.
- AYERS, J. L. & SELVERSTON, A. I. (1979). Monosynaptic entrainment of an endogenous pacemaker network: A cellular mechanism for von Holst's magnet effect. *J. comp. Physiol.* **129**, 5-17.
- ASADA, Y. & BENNETT, M. V. L. (1971). Experimental alteration of coupling resistance at an electrotonic synapse. *J. Cell. Biol.* **49**, 159-172.
- CALABRESE, R. L. (1977). The neural control of alternate heartbeat coordination states in the leech, *Hirudo medicinalis*. *J. comp. Physiol.* **122**, 111-143.
- HAMMERSEN, F. & STAUDTE, H. W. (1969). Beiträge zum Feinbau der Blutgefäße von Invertebraten. I. Die Ultrastruktur des Sinus Lateralis von *Hirudo medicinalis*. *Z. Zellforsch.* **100**, 215-250.
- KRISTAN, W. B., JR., STENT, G. S. & ORT, C. A. (1974). Neuronal control of swimming in the medicinal leech. I. Dynamics of the swimming rhythm. *J. comp. Physiol.* **94**, 97-119.
- KRISTAN, W. B., BURROWS, M., ELSNER, N., GRILLNER, S., HUBER, F., JANKOWSKA, E., PEARSON, K. G., SEARS, T. A. & STENT, G. S. (1977). Neural control of movement. *Function and Formation of Neural Systems* (ed. G. S. Stent), pp. 329-354. Berlin: Dahlem Konferenzen.

- MANN, H. (1962). *Leeches*. New York: Pergamon Press.
- NICHOLLS, J. G. & WALLACE, B. (1978). Modulation of transmitter release at an inhibitory synapse in the CNS of the leech. *J. Physiol., Lond.* **281**, 157-170.
- PINSKER, H. M. (1977a). *Aplysia* bursting neurons as endogenous oscillators. I. Phase-response curves for pulsed inhibitory synaptic input. *J. Neurophysiol.* **40**, 527-543.
- PINSKER, H. M. (1977b). *Aplysia* bursting neurons as endogenous oscillators. II. Synchronization and entrainment by pulsed inhibitory synaptic input. *J. Neurophysiol.* **40**, 544-556.
- RUSSELL, D. F. & HARTLINE, D. K. (1978). Bursting neural networks: A re-examination. *Science, NY.* **200**, 453-456.
- STRUMWASSER, F. (1967). Types of information stored in single neurons. *Invertebrate Nervous Systems: Their Significance for Mammalian Neurophysiology*. Conference on Invertebrate Nervous Systems (ed. C. A. G. Wiersma), pp. 291-319. Chicago: University of Chicago Press.
- THOMPSON, W. J. & STENT, G. S. (1976a). Neuronal control of heartbeat in the medicinal leech. I. Generation of the vascular constriction rhythm by heart motor neurons. *J. comp. Physiol.* **111**, 261-279.
- THOMPSON, W. J. & STENT, G. S. (1976b). Neuronal control of heartbeat in the medicinal leech. II. Intersegmental coordination of heart motor neuron activity by heart interneurons. *J. comp. Physiol.* **111**, 281-307.
- THOMPSON, W. J. & STENT, G. S. (1976c). Neuronal control of heartbeat in the medicinal leech. III. Synaptic relations of the heart interneurons. *J. comp. Physiol.* **111**, 309-333.
- WAZIRI, R., FRAZIER, W. T. & KANDEL, E. R. (1965). Analysis of pacemaker activity in an identifiable burst generating neuron in *Aplysia*. *Physiologist* **8**, 300.